

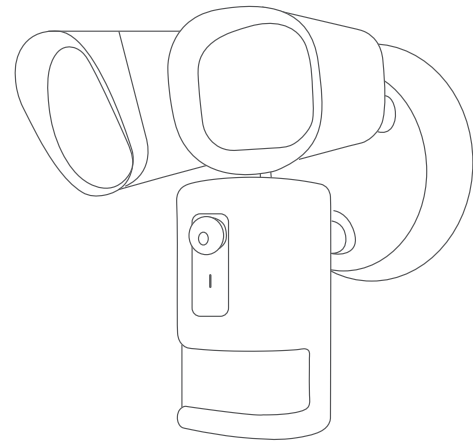

QUICK START GUIDE

Floodlight Camera 2K



Anker Innovations Limited. All rights reserved. eufy Security and eufy Security Logo are trademarks of Anker Innovations Limited, registered in the United States and other countries. All other trademarks are the property of their respective owners.

51005002628 V01

Table of Contents

English	01
Deutsch	16
Español	28
Français	40
Italiano	52
Nederlands	64
Portuguese	76
لَعَرَبِيَّة	87

Safety Instructions	01
What's in the Box	01
Getting Started	02
Installing the Junction Box	04
Mounting Floodlight Camera	07
Adjusting Floodlight Camera	09
Restoring Power	10
Using the Floodlight Camera on the Eufy Security App	10
NOTICE	12

Safety Instructions

1. Shut off power at the fuse or circuit breaker before installing.
2. Do not install the device near flammable surfaces.
3. Must have a licensed electrician install the Floodlight Camera.
4. Do not use the device in environments where the temperature is too high or too low, avoid exposing the device to direct sunshine or very wet environments.
5. The suitable temperature for the product and accessories is -20°C to 50°C .

What's in the Box



Floodlight Camera 2K
(T8424)

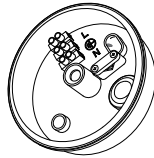

Junction Box



Installation Hook



Central Screw



Central Screw Cap

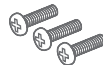
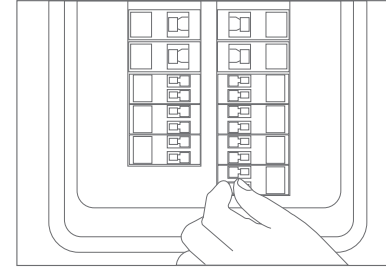

Plate Screws

Getting Started

1. Shut the power off at the breaker in your house. Switch on/off the lights to make sure the electricity in your house is properly shut off.



2. Determine the area you want to be lit and camera coverage is required. Install your Floodlight Camera on the front wall or on a side wall of your house. To get optimal detection and light coverage for the floodlight and camera, install it on a side wall if possible. *

* The motion sensor is more sensitive to movements across the camera field of view than movements towards or away from the sensor. We highly recommend you install the floodlight camera on the side wall.

On the side wall:

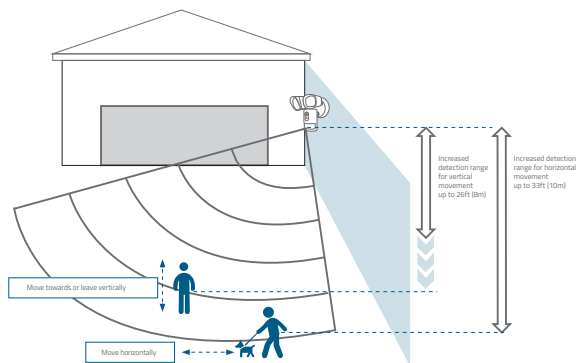

On the front wall:

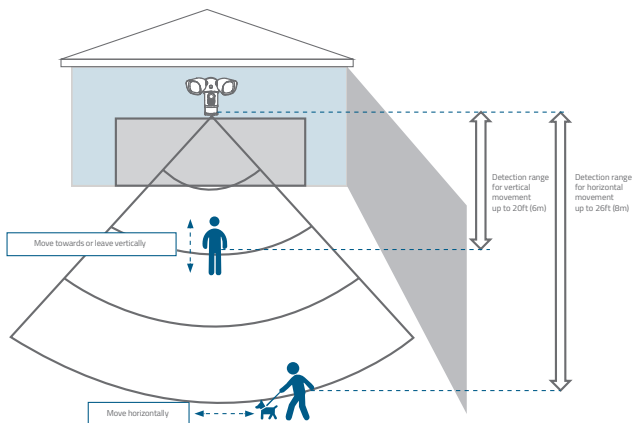

03 EN

Installing the Junction Box

1. Remove the rubber plugs indicated in the illustration below.

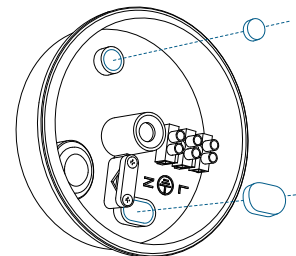

2. Run the existing wire through the hole.

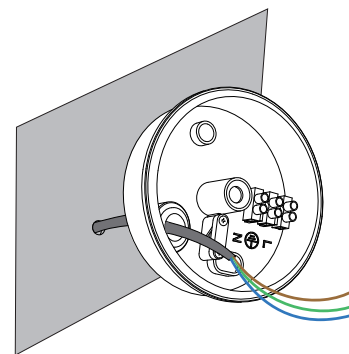

If you don't have existing wires outdoors, contact a licensed electrician to run the wires.

EN 04

3. Install the junction box:

- Orientate the two mounting holes vertically to ensure stable mounting.
- On wooden walls, DO NOT pre-drill holes. Use the screws provided to fix the junction box onto the wall.

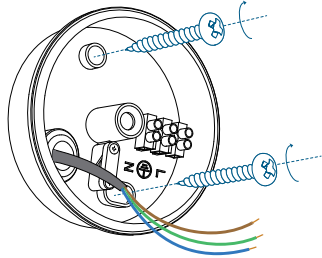

- On walls that are made out of hard materials, such as stucco, brick, or concrete, drill holes with a 15/64 inch (6 mm) drill bit, and then insert the anchors provided into the holes. Use the screws provided to fix the junction box on the wall.

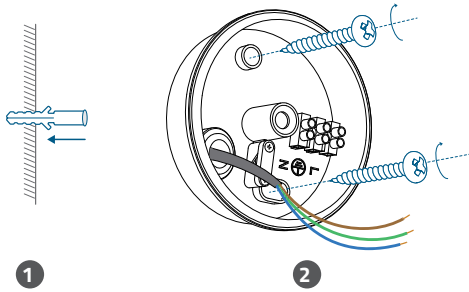

4. Unscrew the bolt with a flat-head screwdriver. Connect the Neutral (blue) / Ground (green / green and yellow) / Live (brown) wire to the Neutral / Ground / Live wire connector in the junction box respectively. Secure the wires tightly to prevent wires from falling.

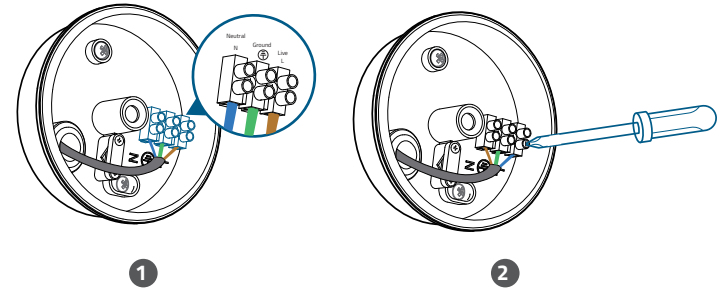

Mounting Floodlight Camera

Hang Floodlight Camera

Hang Floodlight Camera on the junction box with the hook provided.

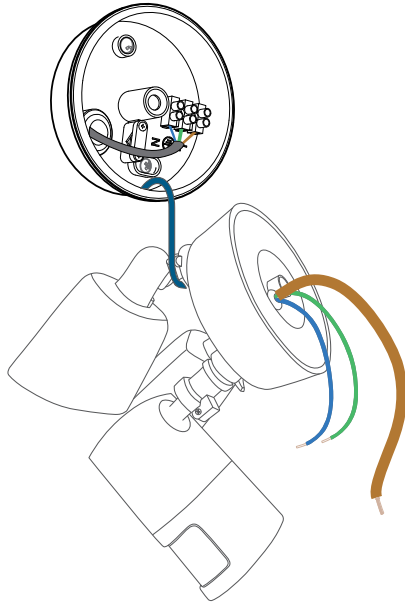

Connect Wires

1. Connect Ground wire from the Floodlight Camera to the Ground wire from the wire connector in the junction box.
2. Connect the Live / Neutral wire from the Floodlight Camera to the Live / Neutral wire from the wire connector in the junction box respectively.

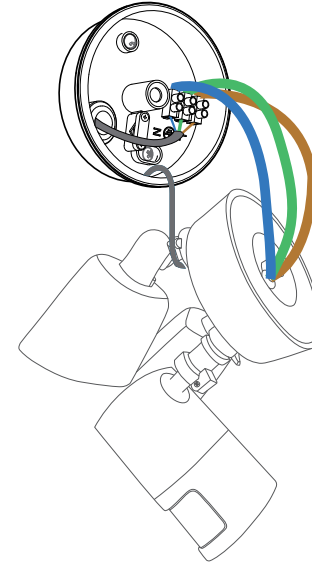

3. Secure the wires with a flat-head screwdriver.



Green / green and yellow, brown and blue wires must connect to the matching colors. Never cross connect.

Mount Floodlight Camera On the Junction Box

1. Align the hole on the junction box with the opening in the Floodlight Camera.
2. Screw the central screw through the center of Floodlight Camera to mount it in position.

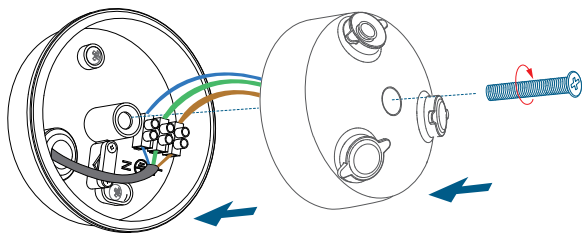

3. Cover the central screw with the central screw cap to prevent it from rusting.

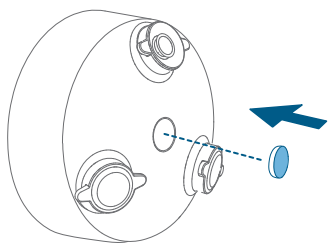

Adjusting Floodlight Camera

1. After installation is complete, loosen the adjustment screws on the camera and floodlight to adjust the camera and light position to the desired angles.
2. Tighten the screws firmly to complete the installation.

09 EN

Restoring Power

Switch on the main circuit breaker in the house. To confirm whether the Floodlight Camera is operating, check the LED indicator. If it is flashing red, it is ready for Eufy Security App setup.



If Floodlight Camera is not powered on, switch off the circuit breaker before checking the wiring of Floodlight Camera.

Using the Floodlight Camera on the Eufy Security App

1. Download the Eufy Security app from the App Store (iOS devices) or Google Play (Android devices).



2. Sign up for a Eufy Security account. Follow the onscreen instructions to connect Floodlight Camera to your Wi-Fi network. Now you can check live stream in the Eufy Security App.



The Floodlight Camera can be used only after your phone and the Floodlight Camera are connected to the same wireless network.

EN 10

For troubleshooting, check the Help section in the Eufy Security app.
Refer to the app for information on the various LED status indications.

NOTICE

FCC Statement

This device complies with Part 15 of the FCC Rules. Operation is subject to the following two conditions: (1) this device may not cause harmful interference, and (2) this device must accept any interference received, including interference that may cause undesired operation.

Warning: Changes or modifications not expressly approved by the party responsible for compliance could void the user's authority to operate the equipment.

Note: This equipment has been tested and found to comply with the limits for a Class B digital device, pursuant to Part 15 of the FCC Rules. These limits are designed to provide reasonable protection against harmful interference in a residential installation.

This equipment generates uses and can radiate radio frequency energy and, if not installed and used in accordance with the instructions, may cause harmful interference to radio communications. However, there is no guarantee that interference will not occur in a particular installation. If this equipment does cause harmful interference to radio or television reception, which can be determined by turning the equipment off and on, the user is encouraged to try to correct the interference by one or more of the following measures: (1) Reorient or relocate the receiving antenna. (2) Increase the separation between the equipment and receiver. (3) Connect the equipment into an outlet on a circuit different from that to which the receiver is connected. (4) Consult the dealer or an experienced radio/ TV technician for help.

FCC Radio Frequency Exposure Statement

The device has been evaluated to meet general RF exposure requirements. The device can be used in fixed/mobile exposure condition. The min separation distance is 20cm.

Notice: Shielded cables

All connections to other computing devices must be made using shielded cables to maintain compliance with FCC regulations.

The following importer is the responsible party:

Company Name: POWER MOBILE LIFE, LLC
Address: 400 108th Ave NE Ste 400, Bellevue, WA 98004-5541
Telephone: 1-800-988-7973

 This product complies with the radio interference requirements of the European Community.

Declaration of Conformity

Hereby, Anker Innovations Limited declares that this device is in compliance with the essential requirements and other relevant provisions of Directive 2014/53/EU. For the declaration of conformity, visit www.eufylife.com

Do not use the Device in the environment at too high or too low temperature, never expose the Device under strong sunshine or too wet environment.

The suitable temperature for the product and accessories is -20°C-50°C.

RF exposure information: The Maximum Permissible Exposure (MPE) level has been calculated based on a distance of d=20 cm between the device and the human body. To maintain compliance with RF exposure requirement, use product that maintain a 20cm distance between the device and the human body.

Wi-Fi Operating Frequency Range: 2412~2472MHz for EU;

Wifi Max Output Power: 16.09dBm(ERIP)

Bluetooth Operating Frequency Range: 2402~2480 MHz; Bluetooth Max Output Power: 8.61 dBm(EIRP)

Anker Innovations Deutschland GmbH | Georg-Muche-Strasse 3, 80807 Munich, Germany

Anker Technology (UK) Ltd | Suite B, Fairgate House, 205 Kings Road, Tyseley, Birmingham, B11 2AA, United Kingdom

 This product is designed and manufactured with high quality materials and components, which can be recycled and reused.

 This symbol means the product must not be discarded as household waste, and should be delivered to an appropriate collection facility for recycling. Proper disposal and recycling helps protect natural resources, human health and the environment. For more information on disposal and

recycling of this product, contact your local municipality, disposal service, or the shop where you bought this product.

IC Statement

This device complies with Industry Canada licence-exempt RSS standard(s). Operation is subject to the following two conditions:

- (1) this device may not cause interference, and
- (2) this device must accept any interference, including interference that may cause undesired operation of the device."

Le présent appareil est conforme aux CNR d'Industrie Canada applicables aux appareils radio exempts de licence. L'exploitation est autorisée aux deux conditions suivantes:

- (1) l'appareil n' doit pas produire de brouillage, et
- (2) l'utilisateur de l'appareil doit accepter tout brouillage radioélectrique subi, même si le brouillage est susceptible d'en compromettre le fonctionnement."

This Class B digital apparatus complies with Canadian ICES-003.

Cet appareil numérique de la classe B est conforme à la norme NMB-003 du Canada.

IC RF Statement

When using the product, maintain a distance of 20cm from the body to ensure compliance with RF exposure requirements.

Lors de l'utilisation du produit, maintenez une distance de 20 cm du corps afin de vous conformer aux exigences en matière d'exposition RF.

FCC ID: 2AOKB-T8420X IC: 23451-T8420X

Anker Innovations Limited

Room 1318-19, Hollywood Plaza, 610 Nathan Road, Mongkok, Kowloon, Hong Kong

Inhaltsverzeichnis

Sicherheitsinformationen	16
Im Lieferumfang	16
Erste Schritte	17
Installieren der Anschlussdose	19
Montage der Überwachungskamera mit Scheinwerfer	22
Anpassen der Überwachungskamera mit Scheinwerfer	25
Wiederherstellen der Stromverbindung	25
Verwenden der Überwachungskamera mit Scheinwerfer über die eufy Security-App	25

Sicherheitsinformationen

1. Trennen Sie die Stromversorgung vor der Installation über die Sicherung oder den Hauptschalter.
2. Installieren Sie das Gerät nicht in der Nähe brennbarer Oberflächen.
3. Die Überwachungskamera mit Scheinwerfer muss von einem qualifizierten Elektriker installiert werden.
4. Verwenden Sie das Gerät nicht in Umgebungen mit zu hoher oder zu niedriger Temperatur; setzen Sie das Gerät niemals starker Sonneneinstrahlung oder einer zu feuchten Umgebung aus.
5. Der zulässige Temperaturbereich für das Produkt und das Zubehör liegt zwischen -20 °C und 50 °C.

Im Lieferumfang

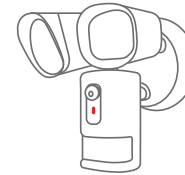

Floodlight Camera 2K
(T8424)

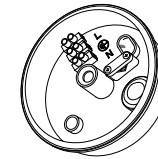

Anschlussdose



Montagehaken



Zentralschraube



Abdeckung Zentralschraube

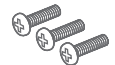

Plattenschrauben

Erste Schritte

1. Trennen Sie die Stromversorgung über den Hauptschalter. Schalten Sie das Licht ein/aus, um sicherzustellen, dass die Stromversorgung ordnungsgemäß getrennt wurde.

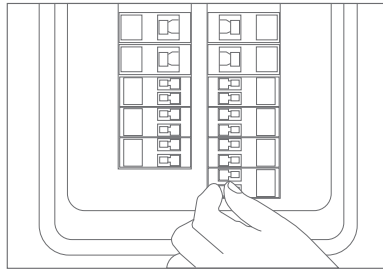

2. Gehen Sie in den Bereich, der ausgeleuchtet und von der Kamera überwacht werden soll, und bringen Sie die Überwachungskamera mit Scheinwerfer an der Vorder- oder Seitenwand an. Letzteres wird ausdrücklich empfohlen, um eine optimale Abdeckung für Scheinwerfer und Kamera zu erhalten.*

*Der Bewegungssensor reagiert empfindlicher auf Bewegungen im Sichtfeld der Kamera als auf Bewegungen zum Sensor oder vom Sensor weg. Es wird ausdrücklich empfohlen, die Überwachungskamera mit Scheinwerfer an der Seitenwand anzubringen.

An der Seitenwand:

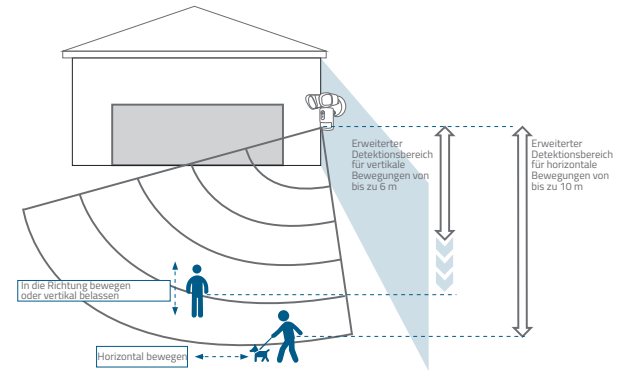

An der Vorderwand:

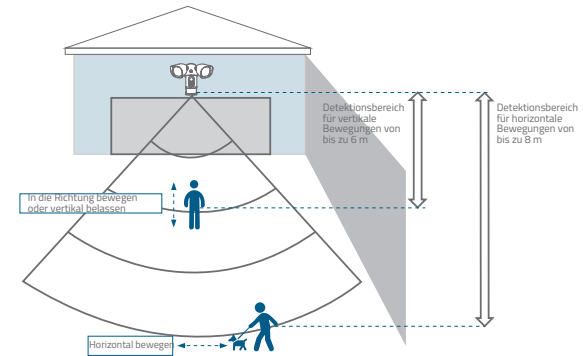

Installieren der Anschlussdose

1. Entfernen Sie die in der folgenden Abbildung dargestellten Gummistopfen.

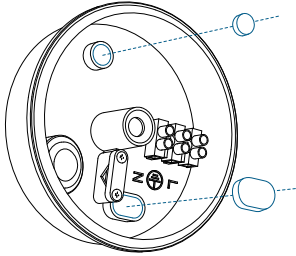

2. Führen Sie das Stromkabel durch Kabeltülle und Zugangsloch.

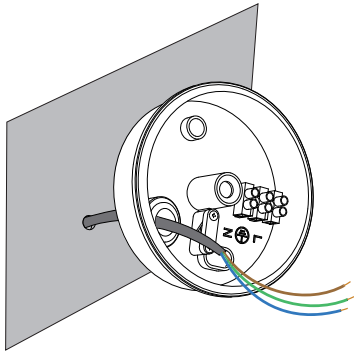

3. Installieren der Anschlussdose:

- Richten Sie die beiden Befestigungslöcher vertikal aus, um eine stabile Montage sicherzustellen.
- Bohren Sie bei Holzwänden KEINE Löcher vor. Verwenden Sie die mitgelieferten Schrauben, um die Anschlussdose an der Wand anzubringen.

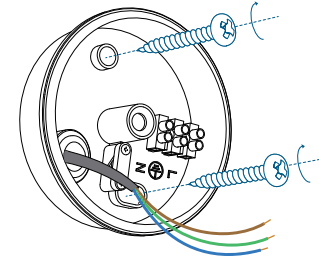

- Bohren Sie bei Wänden aus harten Materialien wie Stuck, Backstein oder Zement Löcher mit einem 6-mm-Bohrer und setzen Sie die mitgelieferten Dübel in die Löcher ein. Verwenden Sie die mitgelieferten Schrauben, um die Anschlussdose an der Wand zu befestigen.

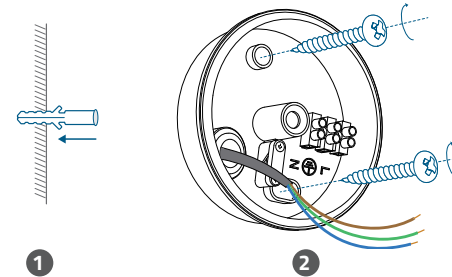

4. Lösen Sie die Schraube mit einem Schlitzschraubendreher.
Verbinden Sie den Neutralleiter (blau)/den Schutzleiter (grün/
grün-gelb)/die Phase (braun) mit den entsprechenden Anschlüssen der
Anschlussdose. Befestigen Sie sie gründlich, um zu verhindern, dass sie
sich lösen.

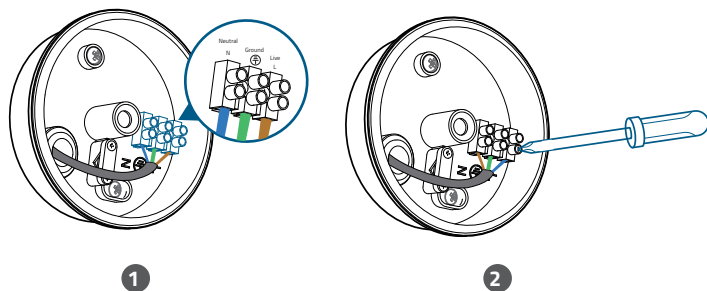

Montage der Überwachungskamera mit Scheinwerfer

Aufhängen der Überwachungskamera mit Scheinwerfer

Hängen Sie die Überwachungskamera mit Scheinwerfer unter Verwendung
des mitgelieferten Hakens an der Anschlussdose auf.

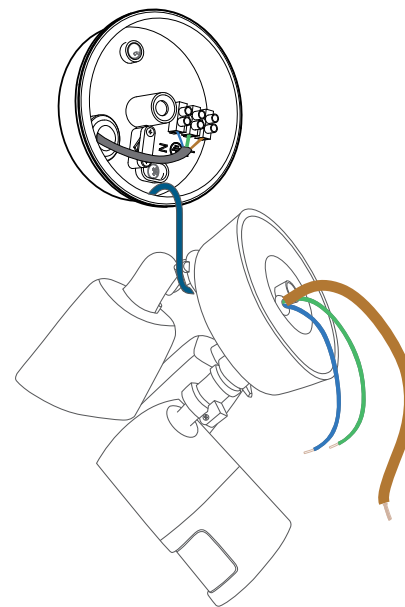

Anschließen der Drähte

1. Verbinden Sie den Schutzleiter der Überwachungskamera mit Scheinwerfer mit dem Schutzleiter des Anschlusses in der Anschlussdose.
2. Verbinden Sie die Phase/den Neutralleiter der Überwachungskamera mit Scheinwerfer mit der Phase/dem Neutralleiter des Anschlusses in der Anschlussdose.

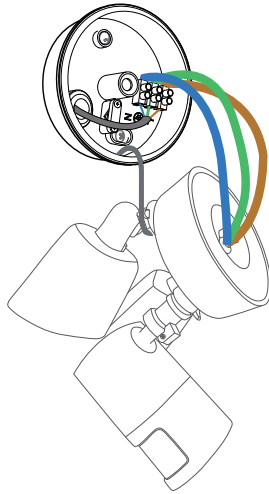

3. Befestigen Sie die Drähte mit einem Schlitzschraubendreher.



Der grüne/grüngelbe, braune und blaue Draht müssen ihren Farben entsprechend angeschlossen werden. Anschlussleitungen und Farben dürfen nicht vertauscht werden.

Anbringen der Überwachungskamera mit Scheinwerfer an der Anschlussdose

1. Richten Sie das Loch an der Anschlussdose an der Öffnung in der Überwachungskamera mit Scheinwerfer aus.
2. Befestigen Sie die Zentralschraube durch die Mitte der Überwachungskamera mit Scheinwerfer, um sie anzubringen.

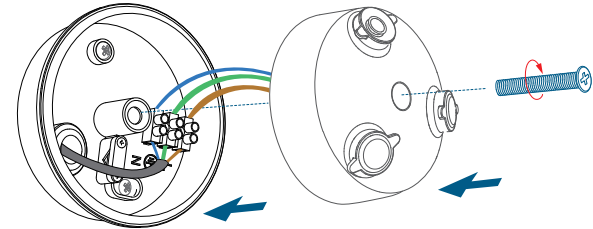

3. Decken Sie die Zentralschraube mit der entsprechenden Abdeckung ab, um ein Rosten zu verhindern.

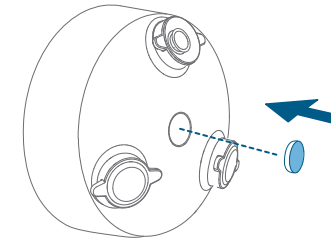

Anpassen der Überwachungskamera mit Scheinwerfer

1. Lösen Sie nach der Installation die Einstellschrauben an der Kamera und den Scheinwerfern, um die Position der Kamera und Lampen an die gewünschten Winkel anzupassen.
2. Ziehen Sie die Schrauben fest an, um die Installation abzuschließen.

Wiederherstellen der Stromverbindung

Schalten Sie den Hauptschalter wieder ein. Bestätigen Sie, dass die Überwachungskamera mit Scheinwerfer funktioniert. Vergewissern Sie sich dazu, ob die rote LED-Anzeige blinkt, also eine Verbindung hergestellt werden kann.



Wenn die mit Scheinwerfer ausgestattete Überwachungskamera nicht eingeschaltet ist, trennen Sie die Stromversorgung über den Hauptschalter, bevor Sie ihre Verkabelung überprüfen.

Verwenden der Überwachungskamera mit Scheinwerfer über die eufy Security-App

1. Laden Sie die eufy Security-App aus dem App Store (iOS-Geräte) oder bei Google Play (Android) herunter.



2. Registrieren Sie ein eufy Security-Konto. Befolgen Sie den Bildschirmanweisungen, um die Überwachungskamera mit Scheinwerfer mit Ihrem WLAN zu verbinden. Nun können Sie den Live-Stream in der eufy Security-App sehen.



Die Überwachungskamera mit Scheinwerfer kann erst verwendet werden, nachdem Sie Telefon und Kamera mit demselben WLAN verbunden haben.

Tipps zur Fehlerbehebung finden Sie im Hilfe-Abschnitt der eufy Security-App.

Informationen zu den unterschiedlichen LED-Statusanzeigen finden Sie in der App.

Tabla de contenidos

Instrucciones de seguridad	28
Contenido de la caja	28
Primeros pasos	29
Instalación de la caja de conexiones	31
Montaje de la cámara con focos	34
Ajuste de la cámara con focos	37
Restablecimiento de la alimentación	37
Uso de la cámara con focos con la aplicación eufy Security	37

Instrucciones de seguridad

1. Antes de realizar la instalación, interrumpa el suministro de alimentación del fusible o el disyuntor.
2. No instale el dispositivo cerca de superficies inflamables.
3. Un electricista profesional debe encargarse de la instalación de la cámara con focos.
4. No utilice el dispositivo en entornos con temperaturas demasiado altas o bajas. Nunca exponga el dispositivo a la luz solar intensa o a entornos demasiado húmedos.
5. La temperatura adecuada para el producto y los accesorios es de $-20\text{ }^{\circ}\text{C}$ a $50\text{ }^{\circ}\text{C}$.

Contenido de la caja



Floodlight Camera 2K
(T8424)

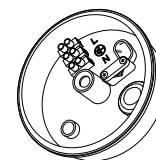

Caja de conexiones



Gancho de instalación



Tornillo central



Tapa del tornillo central



Tornillos de la placa
ES 28

Primeros pasos

1. Desconecte el disyuntor de la vivienda. Encienda y apague las luces para asegurarse de que la electricidad de la vivienda se ha desconectado correctamente.

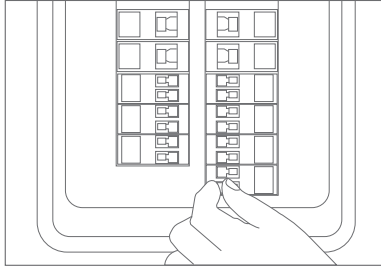

2. Desplácese al área que desea iluminar y al área que necesita que la cámara cubra, e instale la cámara con focos en la pared frontal o lateral. Para obtener una cobertura óptima tanto de los focos como de la cámara, se recomienda la instalación en la pared lateral.*

* El sensor de movimiento es más sensible a los movimientos a través del campo de visión de la cámara que a los movimientos hacia o desde el sensor. Se recomienda encarecidamente instalar la cámara con focos en la pared lateral.

En la pared lateral:

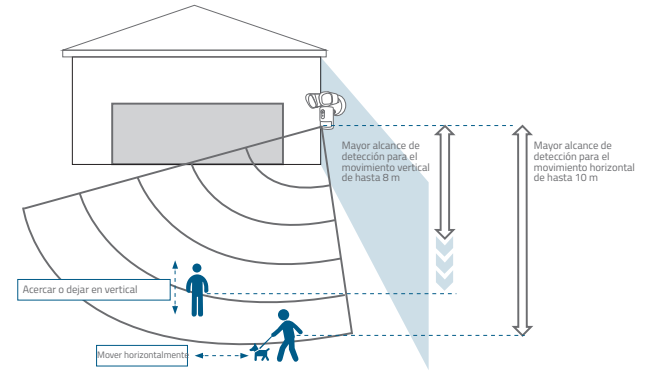

En la pared frontal:

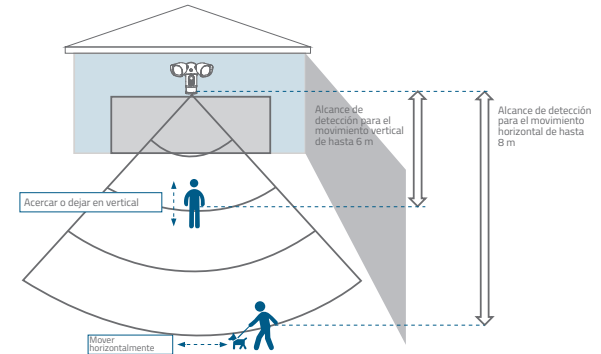

Instalación de la caja de conexiones

1. Retire los tapones de goma indicados en la siguiente ilustración.

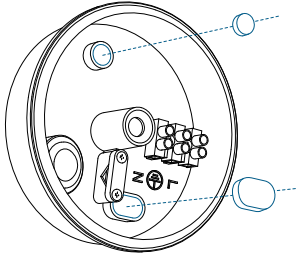

2. Coloque el cable de alimentación a través del ojal y el orificio de acceso.

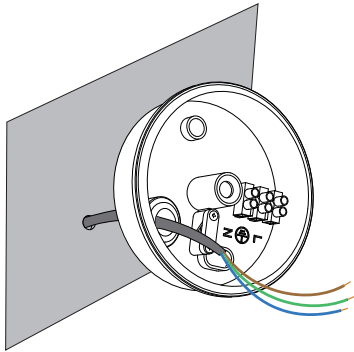

3. Instale la caja de conexiones:

- Oriente los dos agujeros de montaje verticalmente para garantizar que el montaje sea estable.
- **NO** perforo orificios para los tornillos en paredes de madera. Utilice los tornillos suministrados para fijar la caja de conexiones a la pared.

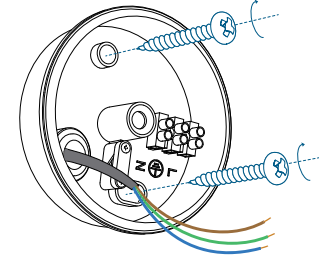

- En paredes fabricadas de materiales duros, como estuco, ladrillo u hormigón, taladre agujeros con una broca de 6 mm (15/64 pulg.) y, a continuación, inserte los tacos suministrados en los orificios. Utilice los tornillos suministrados para fijar la caja de conexiones a la pared.

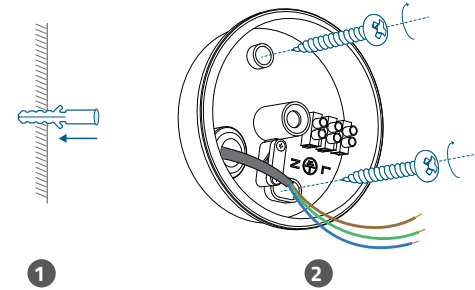

4. Afloje el tornillo con un destornillador de cabeza plana.
Conecte los cables neutro (azul)/
de tierra (verde/verde y amarillo)/energizado (marrón) al conector
neutro/de tierra/energizado de la caja de conexiones respectivamente.
Fije los cables adecuadamente para evitar que se caigan.

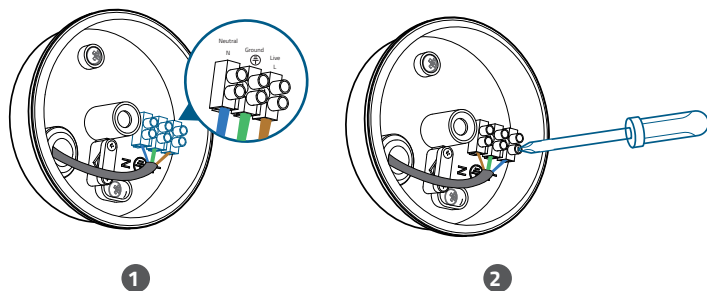

Montaje de la cámara con focos

Cuelgue la cámara con focos:

Cuelgue la cámara con focos en la caja de conexiones mediante el uso del gancho suministrado.

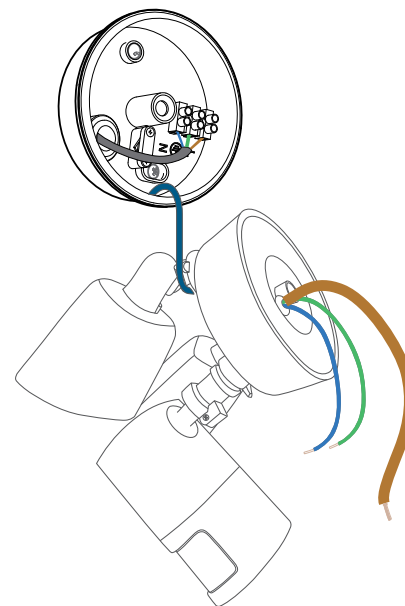

Conecte los cables:

1. Conecte el cable de tierra de la cámara con focos al cable de tierra del conector de tierra de la caja de conexiones.
2. Conecte el cable energizado/neutro de la cámara con focos al cable energizado/neutro del conector de tierra de la caja de conexiones respectivamente.

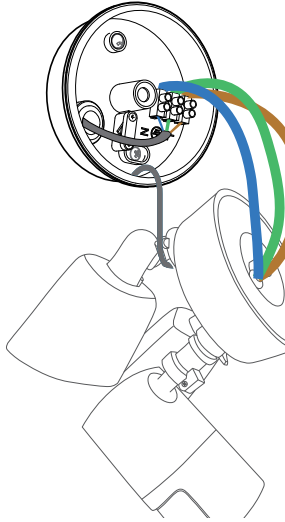

3. Fije los cables con un destornillador de cabeza plana.



Los cables verde/verde y amarillo, marrón y azul se deben conectar con el mismo color. Nunca realice una conexión cruzada.

Montaje de la cámara con focos en la caja de conexiones

1. Alinee el orificio de la caja de conexiones con el orificio de la cámara con focos.
2. Atornille el tornillo central a través del centro de la cámara con focos para montarla en su lugar.

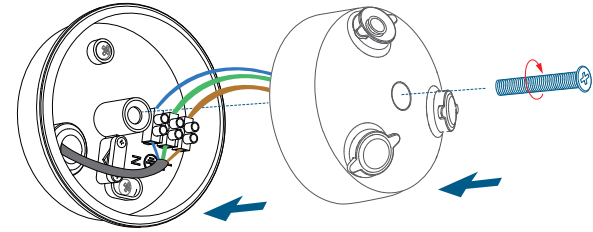

3. Cubra el tornillo central con la tapa del tornillo central para evitar que se oxide.

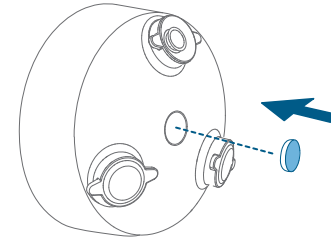

Ajuste de la cámara con focos

1. Una vez que haya completado la instalación, afloje los tornillos de ajuste de la cámara y los focos para ajustar la posición de la cámara y la luz según el ángulo deseado.
2. Apriete los tornillos firmemente para completar la instalación.

Restablecimiento de la alimentación

Active el disyuntor principal de la vivienda. Para confirmar el correcto funcionamiento de la cámara con focos, compruebe que el indicador LED rojo parpadee listo para la conexión.



Si la cámara con focos no está encendida, desconecte el disyuntor antes de comprobar el cableado de la cámara con focos.

Uso de la cámara con focos con la aplicación eufy Security

1. Descargue la aplicación Eufy Security desde la App Store (dispositivos iOS) o Google Play (dispositivos Android).



2. Regístrese para crear una cuenta eufy Security. Siga las instrucciones en pantalla para conectar la cámara con focos a la red Wi-Fi. A continuación, compruebe la transmisión en directo en la aplicación eufy Security.



La cámara con focos solo se puede utilizar una vez que el teléfono y la cámara se hayan conectado a la misma red inalámbrica.

Para solucionar problemas, consulte la sección Ayuda de la aplicación eufy Security.

Consulte la aplicación para obtener información sobre el significado de los distintos estados del LED.

Sommaire

Consignes de sécurité	40
Contenu de la boîte	40
Premiers pas	41
Installation de la boîte de jonction	43
Montage de la caméra Floodlight	46
Ajustement de la caméra Floodlight	49
Restaurer l'électricité	49
Utilisation de la caméra Floodlight avec l'application eufy Security	49

Consignes de sécurité

1. Coupez l'alimentation au niveau du fusible ou du disjoncteur avant l'installation.
2. N'installez pas l'appareil à proximité de surfaces inflammables.
3. La caméra Floodlight doit être installée par un électricien agréé.
4. Ne pas utiliser l'appareil dans un environnement où la température est trop élevée ou trop basse, ne jamais exposer l'appareil à la forte lumière du soleil ni à un environnement trop humide.
5. La température appropriée pour le produit et les accessoires est comprise entre -20 °C et 50 °C.

Contenu de la boîte

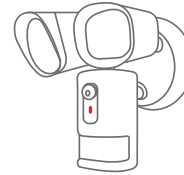

Floodlight Camera 2K
(T8424)

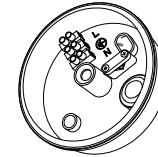

Boîte de jonction



Crochet
d'installation



Vis centrale



Capuchon de la vis centrale

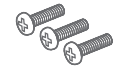

Vis de la plaque

Premiers pas

1. Coupez l'alimentation au niveau du disjoncteur de votre maison. Allumez/éteignez les lumières pour vous assurer que l'électricité de votre maison est correctement coupée.

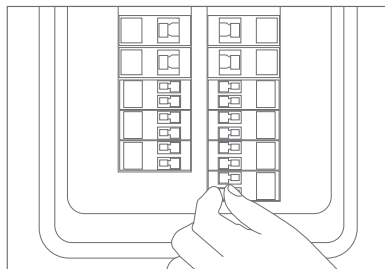

2. Accédez à la zone à éclairer et à la zone que vous souhaitez filmer, puis installez votre caméra Floodlight sur le mur avant ou latéral. Cette dernière méthode est vivement recommandée pour obtenir une couverture optimale du projecteur et de la caméra.*

* Le détecteur de mouvement est plus sensible aux mouvements à travers le champ de vision de la caméra qu'aux mouvements en direction du capteur ou à ceux qui s'en éloignent. Nous vous recommandons vivement d'installer la caméra sur le mur latéral.

Sur le mur latéral :

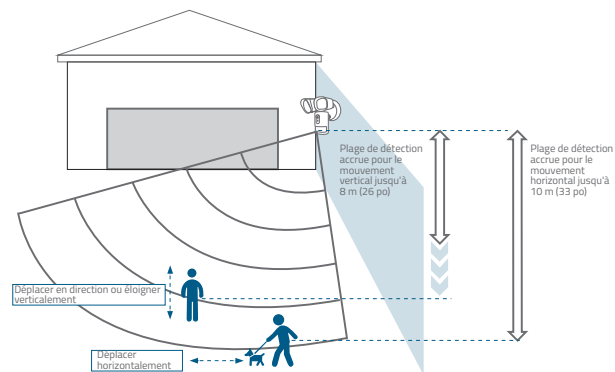

Sur le mur avant :

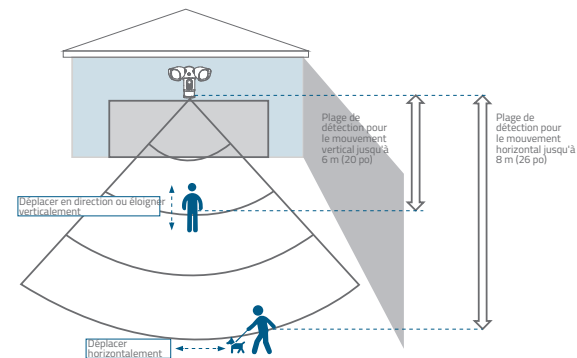

Installation de la boîte de jonction

1. Retirez les bouchons en caoutchouc indiqués dans l'illustration ci-dessous.

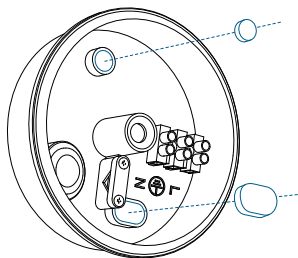

2. Faites passer le câble d'alimentation à travers le passe-câble et le trou d'accès.

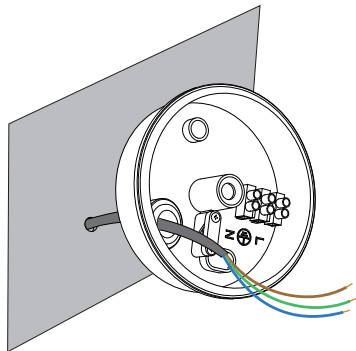

3. Installer la boîte de jonction :

- Orientez les deux trous de montage verticalement pour garantir un montage stable.
- Sur les murs en bois, ne pré-percez PAS de trous. Utilisez les vis fournies pour fixer la boîte de jonction au mur.

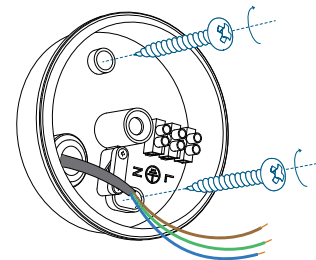

- Sur les murs constitués de matériaux durs, comme les murs en stuc, en brique ou en béton, percez des trous avec un foret de 15/64 pouce (6 mm), puis insérez les ancrages fournis dans les trous. Utilisez les vis fournies pour fixer la boîte de jonction au mur.

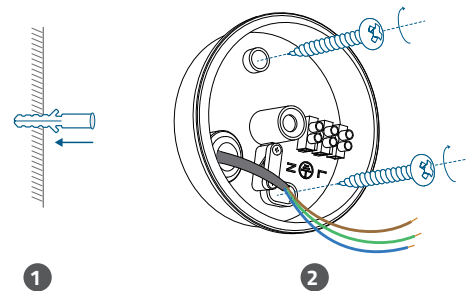

4. Dévissez le boulon de fixation avec un tournevis à tête plate.
Connectez respectivement les fils neutre (bleu)/
de terre (vert/vert et jaune)/sous tension (marron) au connecteur
neutre/de terre/sous tension de la boîte de jonction. Fixez bien les
câbles pour éviter qu'ils ne tombent.

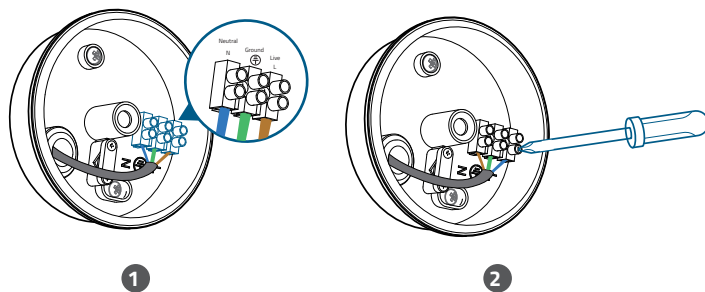

Montage de la caméra Floodlight

Accrocher la caméra Floodlight

Accrochez la caméra Floodlight à la boîte de jonction à l'aide du crochet fourni.

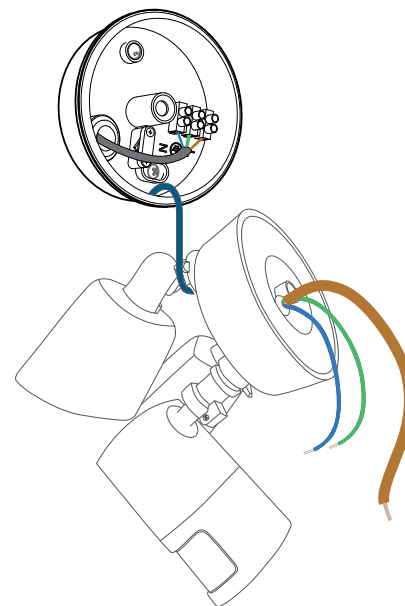

Connecter les fils

1. Connectez le fil de terre de la caméra Floodlight au fil de terre du connecteur de fils de la boîte de jonction.
2. Connectez respectivement le fil sous tension/neutre de la caméra Floodlight au fil sous tension/neutre du connecteur de fils de la boîte de jonction.

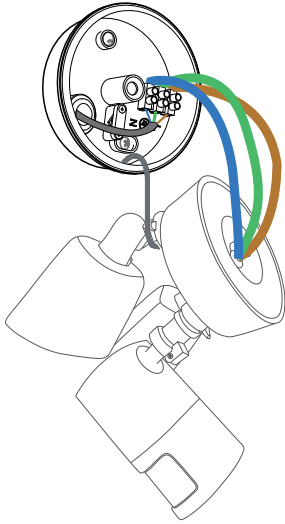

3. Fixez les fils à l'aide d'un tournevis à tête plate.



Les fils vert/vert et jaune, marron et bleu doivent être connectés aux couleurs correspondantes. Veillez à ne jamais effectuer de connexion croisée.

Monter la caméra Floodlight sur la boîte de jonction

1. Alignez le trou de la boîte de jonction avec l'ouverture sur la caméra Floodlight.
2. Vissez la vis centrale sur le centre de la caméra Floodlight pour la fixer en position.

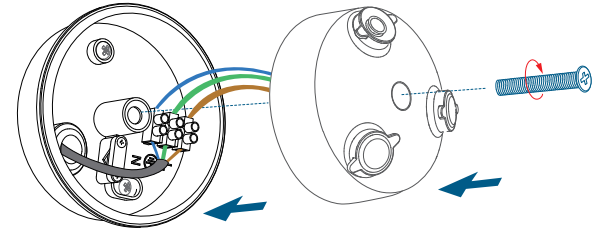

3. Couvrez la vis centrale avec le capuchon de vis centrale pour l'empêcher de rouiller.

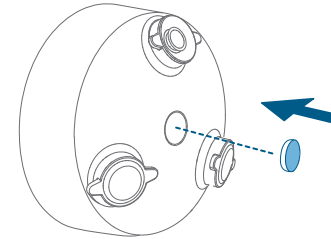

Ajustement de la caméra Floodlight

1. Une fois l'installation terminée, desserrez les vis d'ajustement de la caméra et du projecteur pour ajuster la position de la caméra et de la lumière aux angles désirés.
2. Serrez fermement les vis pour terminer l'installation.

Restaurer l'électricité

Allumez le disjoncteur principal de la maison. Pour vous assurer que la caméra Floodlight fonctionne, vérifiez que le voyant rouge clignote, indiquant qu'elle est prête à être connectée.



Si la caméra Floodlight n'est pas allumée, désactivez le disjoncteur avant de vérifier son câblage.

Utilisation de la caméra Floodlight avec l'application eufy Security

1. Téléchargez l'application Eufy Security sur l'App Store (appareils iOS) ou Google Play (Android).



2. Inscrivez-vous à un compte eufy Security. Suivez les instructions à l'écran pour connecter la caméra Floodlight à votre réseau Wi-Fi. Vous pouvez désormais consulter le flux en direct dans l'application eufy Security.



La caméra Floodlight ne peut être utilisée que si votre téléphone et la caméra Floodlight sont connectés au même réseau sans fil.

Pour les opérations de dépannage, consultez la section « Help » (Aide) de l'application eufy Security.

Reportez-vous à l'application pour plus d'informations sur les différentes indications d'état du voyant.

Indice

Informazioni sulla sicurezza	52
Contenuto della confezione	52
Per iniziare	53
Installazione della scatola di giunzione	55
Montaggio della telecamera a faro	58
Regolare la telecamera a faro	61
Ripristinare l'alimentazione	61
Utilizzo della telecamera a faro sull'app Eufy Security	61

Informazioni sulla sicurezza

1. Scollegare l'alimentazione dal fusibile o dall'interruttore automatico prima dell'installazione.
2. Non installare il dispositivo vicino a superfici infiammabili.
3. La telecamera a faro deve essere installate da un elettricista autorizzato.
4. Non utilizzare il dispositivo in un ambiente con temperatura troppo alta o troppo bassa, non esporre il dispositivo sotto il sole forte o in un ambiente troppo umido.
5. La temperatura adatta per questo prodotto e i relativi accessori è compresa fra -20 °C e 50 °C.

Contenuto della confezione

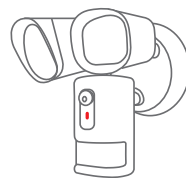

Floodlight Camera 2K
(T8424)

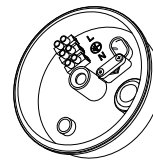

Scatola di giunzione



Gancio di installazione



Vite centrale



Tappo della vite centrale



Viti della piastra

Per iniziare

1. Spegner l'interruttore dell'abitazione. Accendere/Spegnere le luci per assicurarsi che l'alimentazione dell'abitazione sia correttamente spenta.

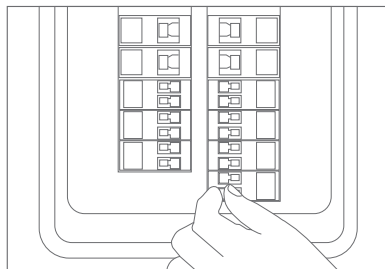

2. Accedere all'area che si desidera illuminare e all'area per cui si necessita della copertura della telecamera e installare la telecamera a faro sulla parete frontale o laterale. Quest'ultima modalità di installazione è vivamente raccomandata per ottenere una copertura ottimale per il proiettore e la telecamera.*

* Il sensore di movimento è più sensibile ai movimenti attraverso il campo visivo della telecamera rispetto ai movimenti in direzione o lontano dal sensore. Consigliamo vivamente di installare la telecamera del proiettore sulla parete laterale.

Sulla parete laterale:

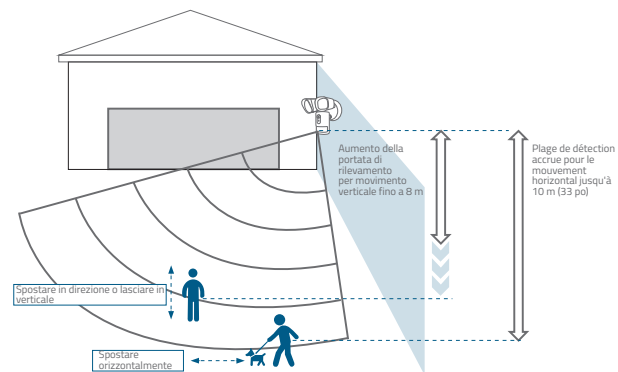

Sulla parete frontale:

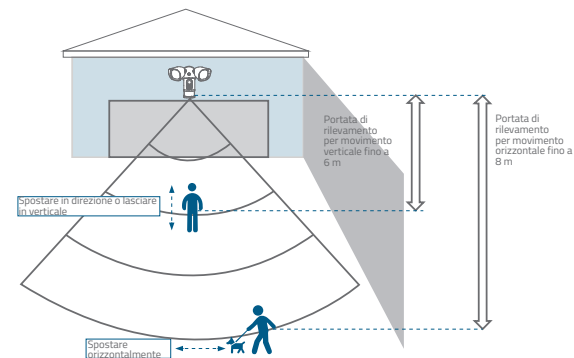

Installazione della scatola di giunzione

1. Rimuovere i tappi di gomma indicati nell'illustrazione seguente.

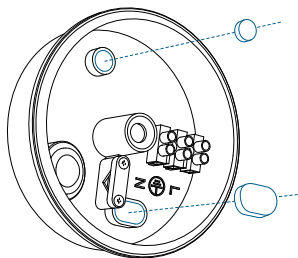

2. Far passare il filo del cavo di alimentazione attraverso l'anello di tenuta e il foro di accesso.

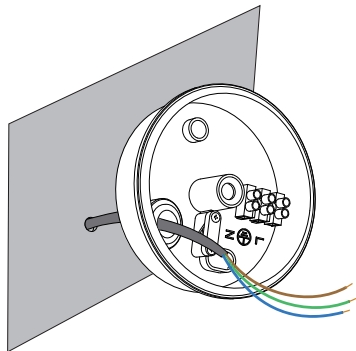

3. Installazione della scatola di giunzione:

- Orientare i due fori di montaggio in verticale per garantire un montaggio stabile.
- Su pareti di legno, NON preforare. Utilizzare le viti fornite per fissare la scatola di giunzione alla parete.

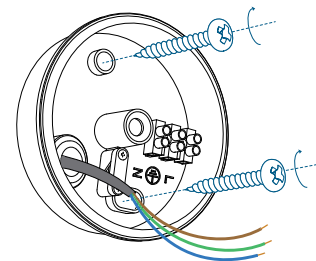

- Su pareti realizzate con materiali duri, come stucchi, mattoni o cemento, praticare dei fori con una punta da trapano da 6 mm, quindi inserire gli ancoraggi forniti nei fori. Utilizzare le viti fornite per fissare la scatola di giunzione alla parete.

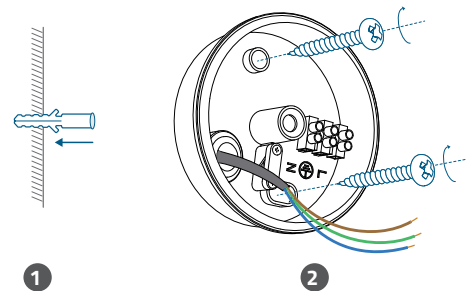

4. Svitare il bullone con un cacciavite a testa piatta.
Collegare il cavo neutro (blu)/terra (verde/verde e giallo)/sotto tensione (marrone) al connettore neutro/terra/sotto tensione nella scatola di giunzione, rispettivamente. Fissare saldamente i fili per evitare cadute.

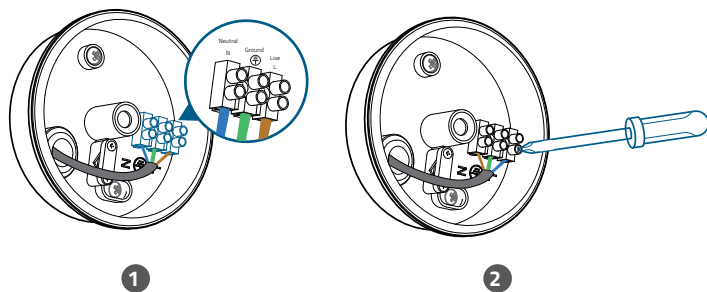

Montaggio della telecamera a faro

Appendere la telecamera a faro

Appendere la videocamera a faro sulla scatola di giunzione con il gancio in dotazione.

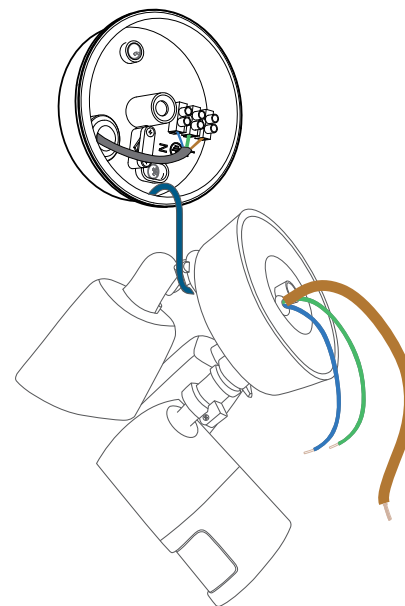

Collegare i cavi

1. Collegare il cavo di terra dalla telecamera a faro al cavo di terra dal connettore dei cavi nella scatola di giunzione.
2. Collegare il cavo Live/neutro dalla telecamera a faro al cavo Live/neutro dal connettore dei cavi nella scatola di giunzione, rispettivamente.

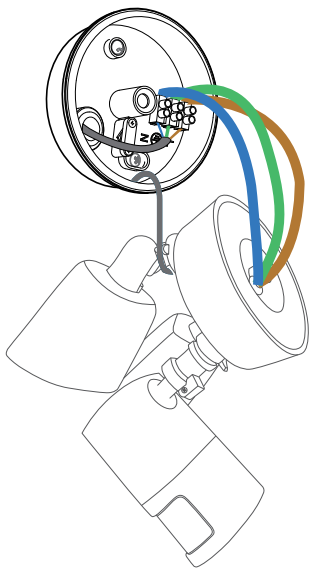

3. Fissare i cavi con un cacciavite a testa piatta.



I fili verde/verde e giallo, marrone e blu devono essere collegati ai colori corrispondenti. Non incrociarli mai.

Montare la telecamera a faro sulla scatola di giunzione.

1. Allineare il foro sulla scatola di giunzione con l'apertura nella telecamera a faro.
2. Avvitare la vite centrale attraverso il centro della telecamera a faro per montarla in posizione.

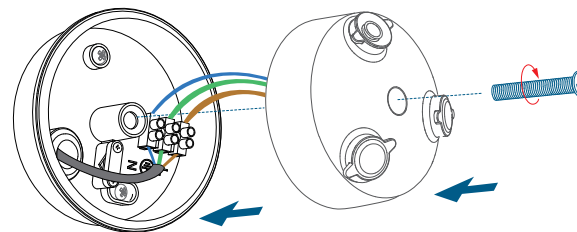

3. Coprire la vite centrale con il tappo della vite centrale per evitare che si arrugginisca.

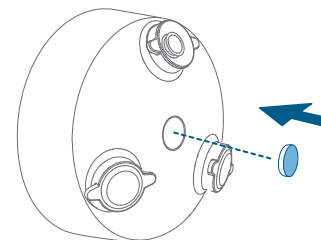

Regolare la telecamera a faro

1. Al termine dell'installazione, allentare le viti di regolazione sulla telecamera e sul proiettore per regolare la telecamera e la posizione della luce alle angolazioni desiderate.
2. Stringere saldamente le viti per completare l'installazione.

Ripristinare l'alimentazione

Accendere l'interruttore principale dell'abitazione. Per confermare che la telecamera a faro sia in funzione, verificare che l'indicatore LED rosso lampeggi a indicare lo stato di pronto per il collegamento.



Se la telecamera a faro non è accesa, spegnere l'interruttore automatico prima di controllarne il cablaggio.

Utilizzo della telecamera a faro sull'app Eufy Security

1. Scaricare l'app Eufy Security dall'App Store (dispositivi iOS) o da Google Play (dispositivi Android).



2. Registrarsi per creare un account eufy Security. Seguire le istruzioni su schermo per connettere la telecamera a faro alla rete Wi-Fi personale. Ora è possibile controllare lo streaming live nell'app eufy Security.



La telecamera a faro può essere utilizzata solo dopo che il telefono e la telecamera a faro sono stati connessi alla stessa rete wireless.

Per la risoluzione dei problemi, consultare la sezione Guida nell'app Eufy Security.

Fare riferimento all'app per informazioni sulle varie indicazioni di stato dei LED.

Inhoudsopgave

Veiligheidsinstructies	64
Wat zit er in de doos?	64
Aan de slag	65
De aansluitdoos installeren	67
De camera met schijnwerpers monteren	70
De camera met schijnwerpers afstellen	73
De stroom opnieuw inschakelen	73
De camera met schijnwerpers gebruiken in de Eufy Security-app	73

Veiligheidsinstructies

1. Schakel de stroom uit bij de zekering of stroomonderbreker alvorens het apparaat te installeren.
2. Installeer het apparaat niet in de buurt van ontvlambare oppervlakken.
3. De camera met schijnwerpers moet door een erkende elektricien worden geïnstalleerd.
4. Gebruik het apparaat niet bij een te hoge of te lage temperatuur, stel het apparaat nooit bloot aan sterk zonlicht of een te natte omgeving.
5. Het geschikte temperatuurbereik voor het product en de accessoires is -20°C tot 50°C .

Wat zit er in de doos?



Floodlight Camera 2K
(T8424)

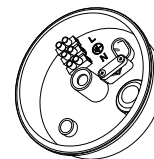

Aansluitdoos



Installatiehaak



Centrale schroef



Centrale schroefdop



Plaatschroeven

Aan de slag

1. Schakel de stroom uit bij de stroomonderbreker in uw huis. Schakel het licht in/uit om te controleren of de elektriciteit in uw huis correct is uitgeschakeld.

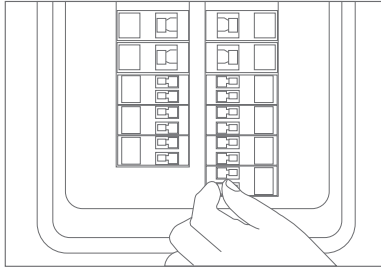

2. Ga naar het gebied dat u wilt verlichten en het gebied waar u cameratoezicht nodig hebt en installeer uw camera met schijnwerpers op de voorwand of op de zijwand. De laatstgenoemde manier wordt sterk aanbevolen om de dekking van de schijnwerpers en de camera te optimaliseren.*

* De bewegingssensor is gevoeliger voor de bewegingen door het gezichtsveld van de camera dan bewegingen in de richting van of weg van de sensor. We raden u aan de camera met schijnwerpers op de zijwand te installeren.

Op de zijwand:

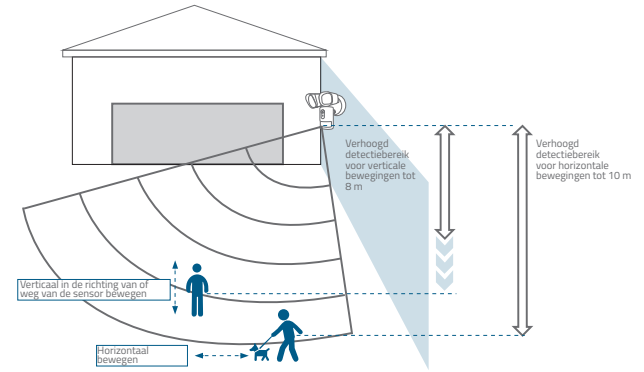

Op de voorwand:

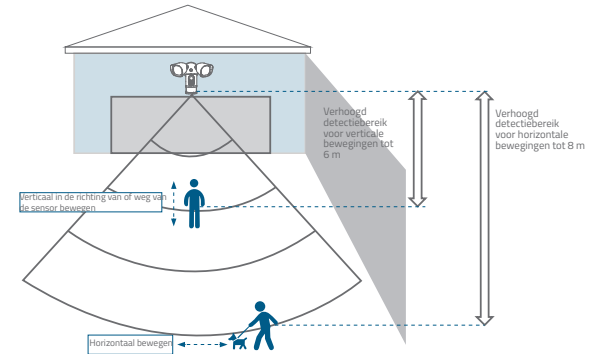

De aansluitdoos installeren

1. Verwijder de rubberen pluggen zoals aangegeven in de onderstaande afbeelding.

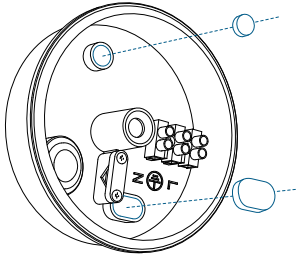

2. Leid de stroomdraad door de doorvoeropening en het toegangsgat.

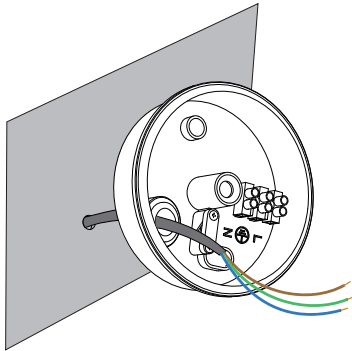

3. De aansluitdoos installeren:

- Plaats de twee montagegaten verticaal om een stabiele montage te waarborgen.
- Boor GEEN gaten voor op houten muren. Gebruik de meegeleverde schroeven om de aansluitdoos op de muur te bevestigen.

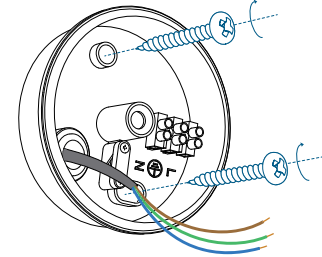

- Boor op muren die zijn gemaakt van harde materialen (zoals stucwerk, baksteen of beton) gaten met een boortje van 6 mm en steek vervolgens de meegeleverde pluggen in de gaten. Gebruik de meegeleverde schroeven om de aansluitdoos op de muur te bevestigen.

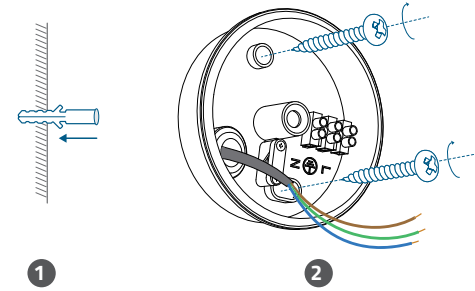

4. Schroef de bout los met een platte schroevendraaier.

Sluit de nuldraad (blauw) / aarddraad (groen / groen en geel) / fasedraad (bruin) aan op respectievelijk de aansluitpunten voor de nuldraad / aarddraad / fasedraad in de aansluitdoos. Zet de draden stevig vast om te voorkomen dat ze losraken.

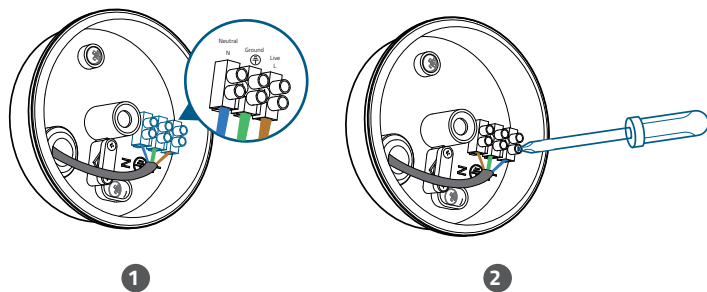

De camera met schijnwerpers monteren

De camera met schijnwerpers ophangen

Hang de camera met schijnwerpers met de meegeleverde haak aan de aansluitdoos.

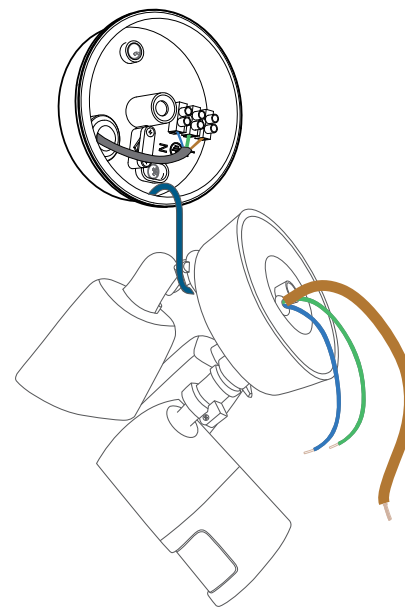

De draden aansluiten

1. Sluit de aarddraad van de camera met schijnwerpers aan op het aansluitpunt voor de aarddraad in de aansluitdoos.
2. Sluit de fasedraad / nuldraad van de camera met schijnwerpers aan op respectievelijk de aansluitpunten voor de fasedraad / nuldraad in de aansluitdoos.

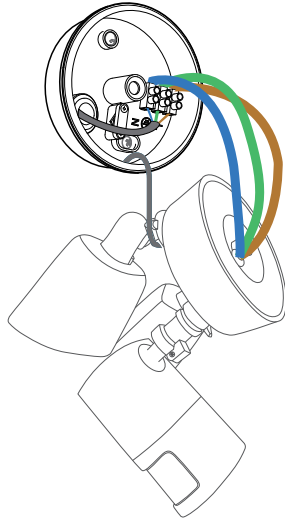

3. Zet de draden vast met een platte schroevendraaier.



Groene / groene en gele, bruine en blauwe draden moeten worden aangesloten op de bijbehorende kleuren. Sluit nooit verschillende kleuren op elkaar aan.

Bevestig de camera met schijnwerpers aan de aansluitdoos

1. Lijn het gat op de aansluitdoos uit met de opening in de camera met schijnwerpers.
2. Schroef de centrale schroef door het midden van de camera met schijnwerpers om deze op zijn plek te monteren.

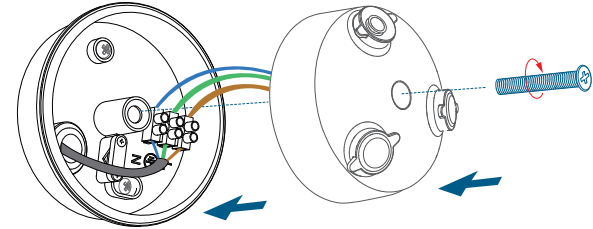

3. Bedek de centrale schroef met de centrale schroefkop om roestvorming te voorkomen.

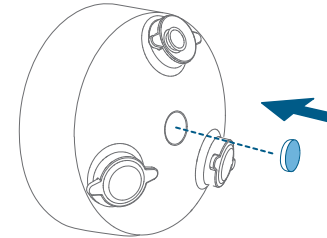

De camera met schijnwerpers afstellen

1. Nadat de installatie is voltooid, draait u de stelschroeven op de camera en schijnwerpers los om de positie en de hoek van de camera en het licht naar wens aan te passen.
2. Draai de schroeven stevig vast om de installatie te voltooien.

De stroom opnieuw inschakelen

Schakel de hoofdstroomonderbreker in het huis in. Bevestig of de camera met schijnwerpers werkt door te controleren of het rode led-indicatielampje knippert om aan te geven dat de camera gereed is voor verbinding.



Als de camera met schijnwerpers niet is ingeschakeld, schakel de stroomonderbreker dan uit alvorens u de bedrading van de beveiligingscamera controleert.

De camera met schijnwerpers gebruiken in de Eufy Security-app

1. Download de eufy Security-app uit de App Store (iOS-apparaten) of Google Play (Android-apparaten).



2. Meld u aan voor een eufy Security-account. Volg de instructies op het scherm om de camera met schijnwerpers te verbinden met uw wifi-netwerk. U kunt nu de livestream bekijken in de eufy Security-app.



De camera met schijnwerpers kan alleen worden gebruikt nadat uw telefoon en de camera zijn verbonden met hetzelfde draadloze netwerk.

Als u problemen ondervindt, raadpleeg dan het Help-gedeelte in de Eufy Security-app.

Raadpleeg de app voor informatie over de verschillende statusaanduidingen van de led-lampjes.

Índice

Instruções de segurança	76
Conteúdo da embalagem	76
Começar	77
Instalar a caixa de ligação	79
Instalar a Câmara de holofote	82
Ajustar a Câmara de holofote	85
Repor a energia	85
Utilizar a Câmara de holofote na aplicação Eufy Security	85

Instruções de segurança

1. Desligar a alimentação dos fusíveis ou no disjuntor antes da instalação.
2. Não instalar o dispositivo perto de superfícies inflamáveis.
3. A Câmara de holofote deve ser instalada por um electricista profissional.
4. Não utilizar o dispositivo em ambientes com temperaturas demasiado altas ou baixas, nunca expor o dispositivo a luz solar forte ou a ambientes demasiado molhados.
5. A temperatura adequada para o produto e os acessórios é entre -20 °C e 50 °C.

Conteúdo da embalagem

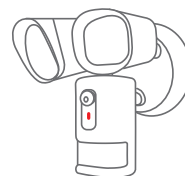

Floodlight Camera 2K
(T8424)

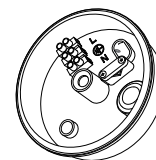

Caixa de ligação



Gancho de instalação



Parafuso central



Tampa do parafuso central

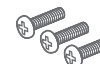

Parafusos de placa

Começar

1. Corte a alimentação do disjuntor na sua habitação. Ligue/desligue as luzes para se certificar de que a eletricidade na sua habitação está realmente cortada.

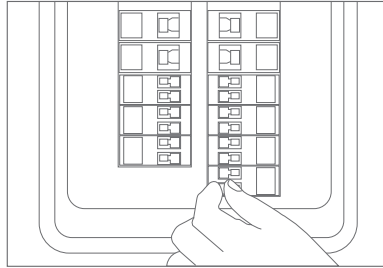

2. Aceda à área que quer que fique iluminada e à área que quer coberta pela câmara e instale a sua Câmara de holofote na parede da frente ou na parede lateral. Esta última forma é altamente recomendada para a obtenção de uma cobertura ideal para o holofote e a câmara.*

* O sensor de movimento é mais sensível aos movimentos no campo de visão da câmara do que os movimentos na direção ou fora do sensor. Recomendamos vivamente que instale a câmara de holofote na parede lateral.

Na parede lateral:

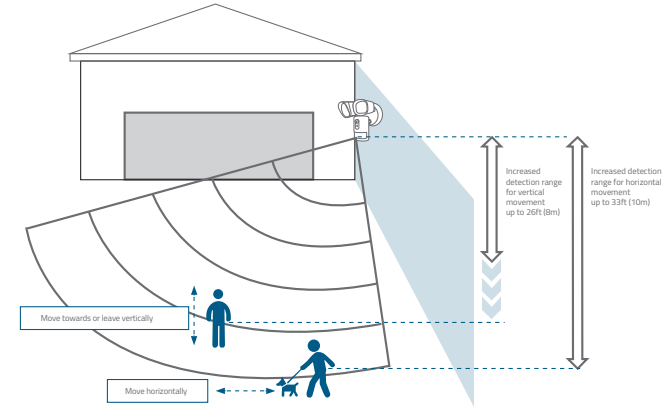

Na parede frontal:

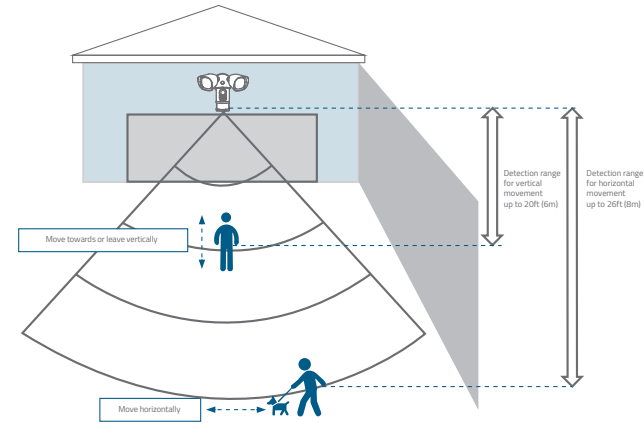

Instalar a caixa de ligação

1. Remova as fichas de borracha indicadas na ilustração abaixo.

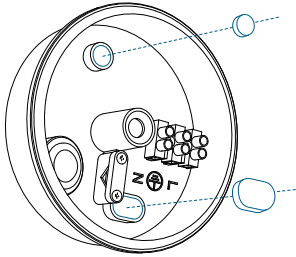

2. Passe o cabo de alimentação através da anilha e do orifício de acesso.

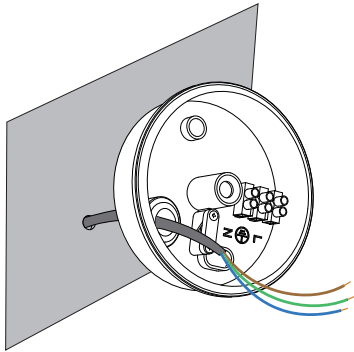

3. Instalar a caixa de ligação:

- Oriente os dois orifícios de instalação verticalmente para garantir uma instalação estável.
- Em paredes de madeira, NÃO perfure orifícios previamente. Utilize os parafusos fornecidos para fixar a caixa de ligação à parede.

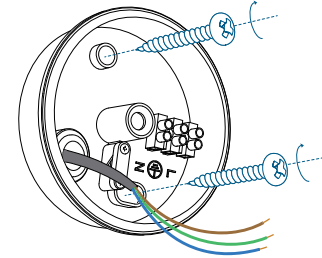

- Em paredes em materiais duros, como estuque, tijolo ou cimento, perfure orifícios com uma broca de 6 mm e, em seguida, insira as âncoras fornecidas nos orifícios. Utilize os parafusos fornecidos para fixar a caixa de ligação à parede.

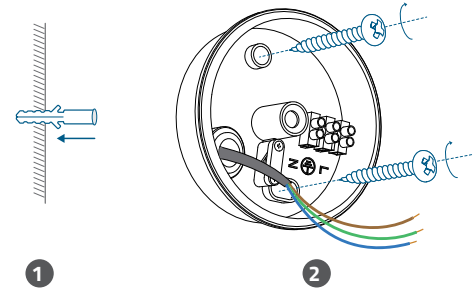

4. Desaperte o parafuso com uma chave de parafusos de ponta plana. Ligue o fio Neutro (azul) / Terra (verde / verde e amarelo) / Sob tensão (castanho) ao conector Neutro / Terra / Sob tensão respetivamente na caixa de ligação. Fixe bem os fios para evitar que algum caia.

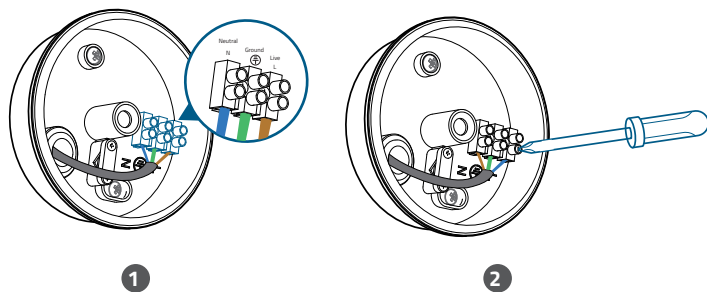

Instalar a Câmara de holofote

Pendurar a Câmara de holofote

Pendure a Câmara de holofote na caixa de ligação com o gancho fornecido.

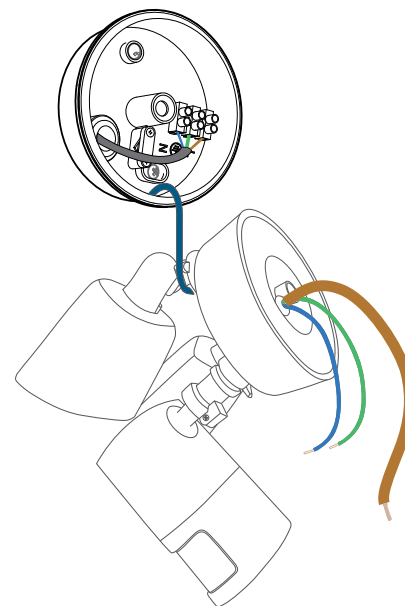

Ligar fios

1. Ligue o fio Terra da Câmara de holofote ao fio Terra do conector de fios na caixa de ligação.
2. Ligue o fio Sob tensão / Neutro da Câmara de holofote respetivamente ao fio Sob tensão / Neutro do conector de fios na caixa de ligação.

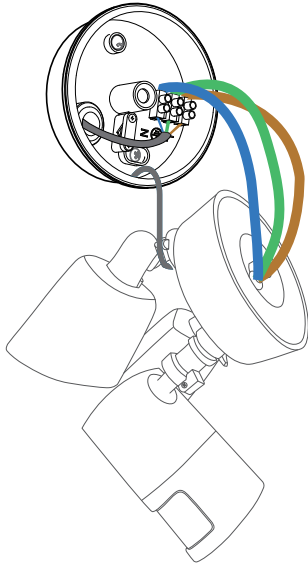

3. Prenda os fios com a ajuda de uma chave de parafusos de ponta plana.



Os fios verde / verde e amarelo, castanho e azul devem ser ligados às cores correspondentes. Nunca entrecruzá-los.

Instalar a Câmara de holofote na Caixa de ligação

1. Alinhe o orifício na caixa de ligação com a abertura na Câmara de holofote.
2. Aperte o parafuso central através do centro da Câmara de holofote para a instalar na posição.

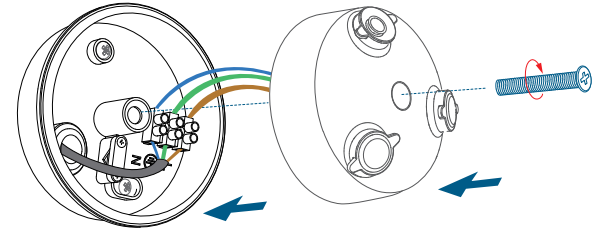

3. Cubra o parafuso central com a tampa do parafuso central para evitar que enferruje.

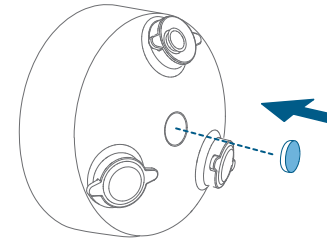

Ajustar a Câmara de holofote

1. Depois da instalação estar concluída, desaperte os parafusos de ajuste na câmara e no holofote para ajustar a posição da câmara e do holofote nos ângulos pretendidos.
2. Aperte os parafusos para concluir a instalação.

Repor a energia

Ligue o disjuntor principal da habitação. Para confirmar o funcionamento da Câmara de holofote, verifique se o indicador vermelho de LED está intermitente a indicar a prontidão para ligação.



Se a Câmara de holofote não estiver ligada, desligue o interruptor antes de verificar a cablagem da Câmara de holofote.

Utilizar a Câmara de holofote na aplicação Eufy Security

1. Transfira a aplicação Eufy Security a partir da App Store (dispositivos iOS) ou da Google Play (dispositivos Android).



2. Crie uma conta Eufy Security. Siga as instruções no ecrã para ligar a Câmara de holofote à sua rede Wi-Fi. Em seguida, já pode ver a transmissão em direto na aplicação Eufy Security.



A Câmara de holofote apenas pode ser utilizada depois de o seu telefone e a Câmara de holofote serem ligados à mesma rede sem fios.

Para a resolução de problemas, consulte a secção Help na aplicação Eufy Security.

Consulte a aplicação para obter informações sobre as várias indicações de estado LED.

بدء الاستخدام

أغلق الطاقة من عند قاطع الكهرباء في منزلك قم بتشغيل/إيقاف تشغيل الأضواء للتأكد من غلق الكهرباء في منزلك بشكل صحيح.

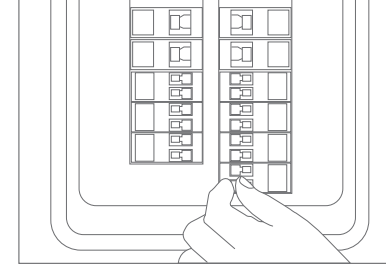

إرشادات السلامة

أغلق الطاقة من عند الصمام أو قاطع الدائرة الكهربائية قبل التثبيت.
لا تقم بتثبيت الجهاز بالقرب من الأسطح القابلة للاشتعال.
يجب أن يكون لديك كهربائي مُعتمد لتثبيت كاميرا Floodlight.
لا تستخدم الجهاز في بيئة ذات درجة حرارة عالية جدًا أو منخفضة جدًا ولا تعرّض الجهاز مطلقًا لأشعة الشمس القوية أو لبيئة مبللة جدًا.
تتراوح درجة الحرارة المناسبة للمنتج والملحقات ما بين 20- درجة مئوية إلى 50 درجة مئوية.

محتوى العلبة



التسجيل بدقة 2K عالي الوضوح
(T8424)

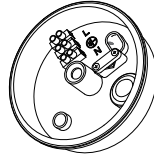

صندوق التوصيل



خطاف التثبيت



مسمار مركزي



غطاء مسمار مركزي



مسامير اللوحة

قم بالوصول إلى المنطقة التي تريد إضاءتها والمنطقة التي تحتاج إلى تغطيتها بالكاميرا، وقم بتثبيت كاميرا Floodlight على الحائط الأمامي أو على الحائط الجانبي. يوصى بشدة استخدام الطريقة الثانية للحصول على تغطية مثالية للأضواء الكاشفة والكاميرا.*

* مستشعر الحركة أكثر حساسية للحركات عبر مجال رؤية الكاميرا من الحركات تجاه المستشعر أو بعيدًا عنه.

على الحائط الجانبي:

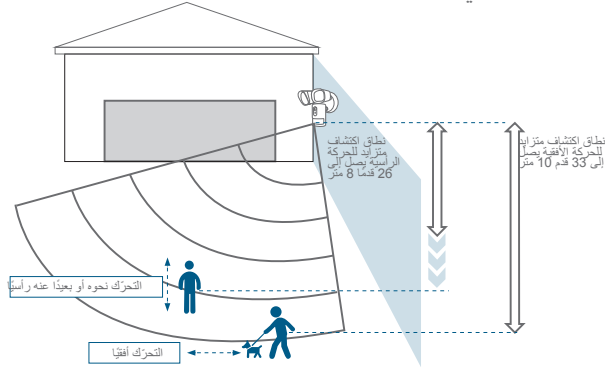

على الحائط الأمامي:

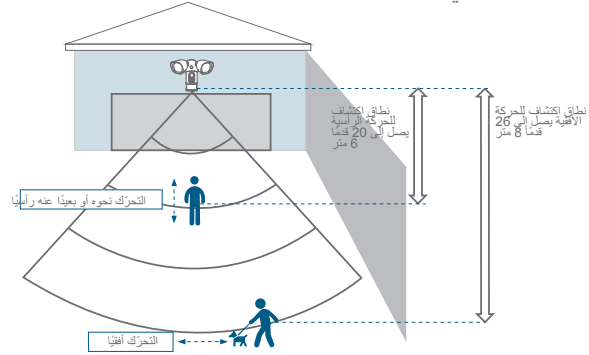

تثبيت صندوق التوصيل

انزع المقابس المطاطية الموضحة في الرسم التوضيحي أدناه.

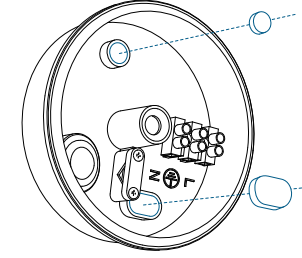

قم بتركيب سلك كابل الطاقة من خلال فتحة التثبيت وفتحة الدخول.

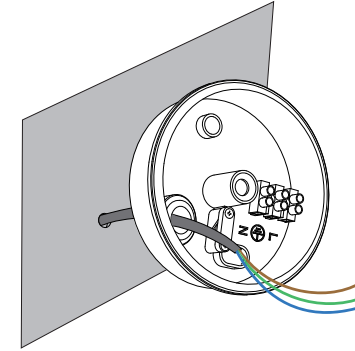

تثبيت صندوق التوصيل:

قم بتوجيه الفتحتين المتلاصقتين عمودياً لضمان تثبيت مستقر.
لا تقم بحفر الثقوب مسبقاً على الجدران الخشبية. استخدم المسامير المرفقة
لتثبيت صندوق التوصيل بالحائط.

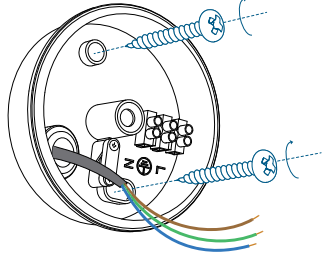

على الجدران المصنوعة من مواد صلبة، مثل الجص، والطوب،
والخرسانة، قم بحفر فتحات بالمتقاب بلقمة مثقب 15/64 بوصة (6 مم)،
ثم قم بإدخال المثبتات المرفقة في الفتحات. استخدم المسامير المرفقة لتثبيت
صندوق التوصيل على الحائط.

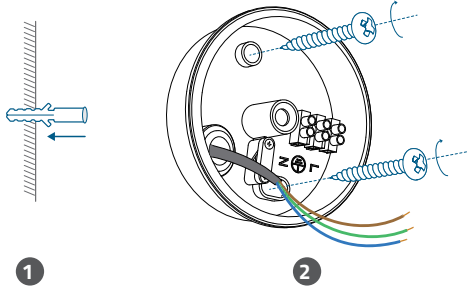

قم بفك المسامير باستخدام مفك ذو رأس مسطحة.

قم بتوصيل السلك المحايد (الأزرق) /

الأرضي (الأخضر / الأخضر والأصفر) / الكهربائي (البنّي) بالموصل
السلكي المحايد / الأرضي / الكهربائي في صندوق التوصيل على التوالي.
أوثق الأسلاك بإحكام لتجنب سقوط الأسلاك.

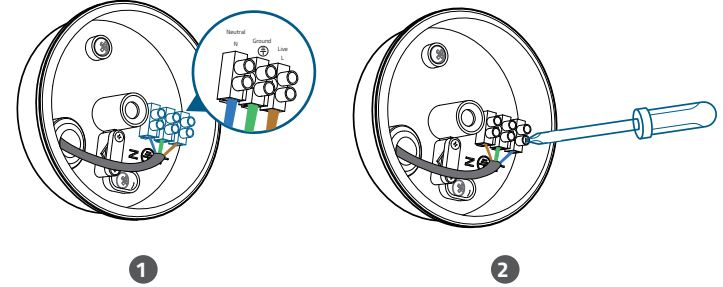

تركيب كاميرا Floodlight
تعليق كاميرا Floodlight
تعليق كاميرا Floodlight في صندوق التوصيل بالخطاف المرفق.

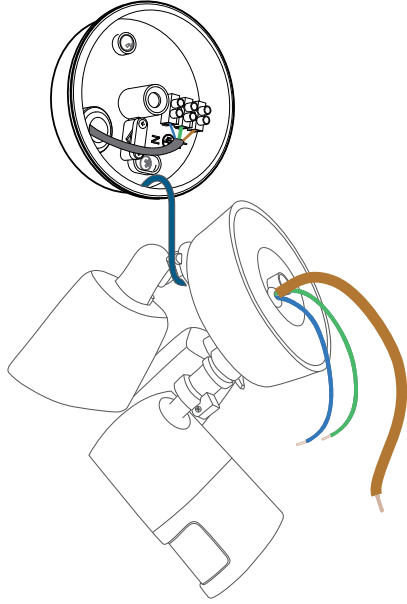

توصيل الأسلاك
قم بتوصيل السلك الأرضي من كاميرا Floodlight بالسلك الأرضي من
الموصل السلكي في صندوق التوصيل.

قم بتوصيل السلك الكهربائي / المحايد من كاميرا Floodlight بالسلك الكهربائي
/ المحايد من الموصل السلكي في صندوق التوصيل على التوالي.

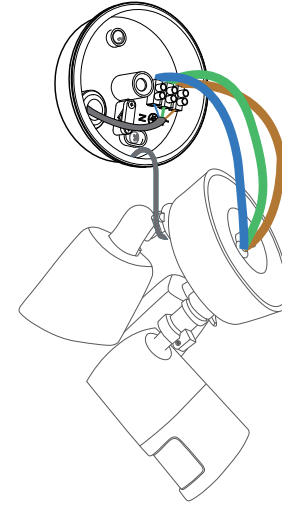

أوثق الأسلاك باستخدام مفك نور رأس مسطحة.



يجب أن يتم توصيل الأسلاك الخضراء / الخضراء، والصفراء،
والبنية، والزرقاء بالألوان المطابقة. لا تقوّت أي توصيلة أبدًا.

تركيب كاميرا Floodlight على صندوق التوصيل
قم بمحاذاة الفتحة الموجودة في صندوق التوصيل مع الفتحة الموجودة في كاميرا
Floodlight.
قم بربط المسامير المركزي عبر مركز كاميرا Floodlight لتثبيتها في مكانها.

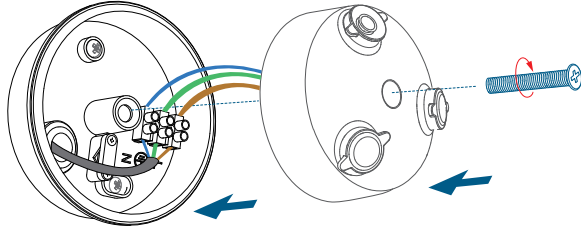

قم بتغطية المسامير المركزي بغطاء المسامير المركزي لمنع من الصدأ.

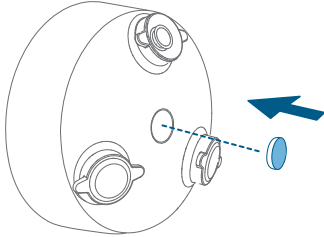

ضبط كاميرا Floodlight

بعد اكتمال التثبيت، قم بفك مسامير الضبط الموجودة على الكاميرا والأضواء
الكاشفة لضبط موضع الكاميرا والضوء على الزوايا المرغوبة.
. أحكم الربط بشدة لإكمال التثبيت

قم بتشغيل قاطع الدائرة الكهربائية الرئيسي في المنزل. للتأكد من عمل
كاميرا Floodlight، تحقق من وميض مؤشر LED الأحمر مشيرًا إلى
جاهزية الاتصال.



إذا لم تكن كاميرا Floodlight قيد التشغيل، فقم بإيقاف تشغيل
قاطع الدائرة الكهربائية قبل التحقق من سلك كاميرا Floodlight.

استخدام كاميرا Floodlight في تطبيق Eufy Security

يمكنك تنزيل تطبيق Eufy Security من App Store (للأجهزة التي تعمل
بنظام iOS) أو من Google Play (للأجهزة التي تعمل بنظام Android).



قم بالتسجيل للحصول على حساب Eufy Security. اتبع التعليمات على
الشاشة لتوصيل كاميرا Floodlight بشبكة Wi-Fi الخاصة بك. يمكنك الآن
التحقق من البث المباشر في تطبيق Eufy Security.



لا يمكن استخدام كاميرا Floodlight إلا بعد اتصال كل من
كاميرا Floodlight وهاتفك بنفس الشبكة اللاسلكية.

لاستكشاف الأخطاء وإصلاحها، تَحَقَّق من قسم المساعدة في تطبيق Eufy Security.
الرجوع إلى التطبيق للحصول على معلومات حول مختلف حالات مؤشرات LED.

Customer Service

Kundenservice | Servicio de atención al cliente Service client
Servizio clienti | Klantenservice خدمة العملاء

▪ Warranty

Garantie | Garantía | Garantie | Garanzia | Garantie | الضمان

12-month limited warranty

12 Monate eingeschränkte Garantie

Garantía limitada de 12 meses

Garantie limitée de 12 mois

Garanzia limitata di 12 mesi

12 maanden beperkte garantie

ضمان محدود لمدة 12 شهرًا

▪ Call Us

Rufen Sie uns an | Contacto por teléfono | Par téléphone

Telefono | Bel ons | اتصل بنا

United States +1 (800) 988 7973 Mon-Fri 9AM-5PM (PT)

United Kingdom +44 (0) 1604 936 200 Mon-Fri 6AM-11AM (GMT)

Germany +49 (0) 69 9579 7960 Mo-Fr 6:00-11:00

▪ Email Us

Senden Sie uns eine E-Mail | Contacto por correo electrónico

Par e-mail | E-mail | Email ons | أرسل لنا بريداً إلكترونيًا

Customer Support: support@eufylife.com

Anker Innovations Limited
Room 1318- 19, Hollywood Plaza, 610 Nathan Road, Mongkok,
Kowloon, Hong Kong

