

Moulinex®

FR

EN

NL

IT

ES

PT



Delicio Tactile 39L Oven

www.moulinex.com

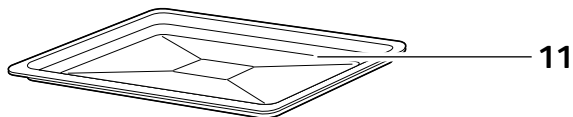
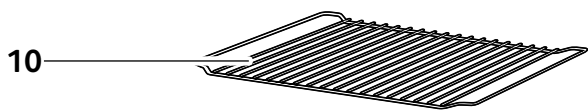
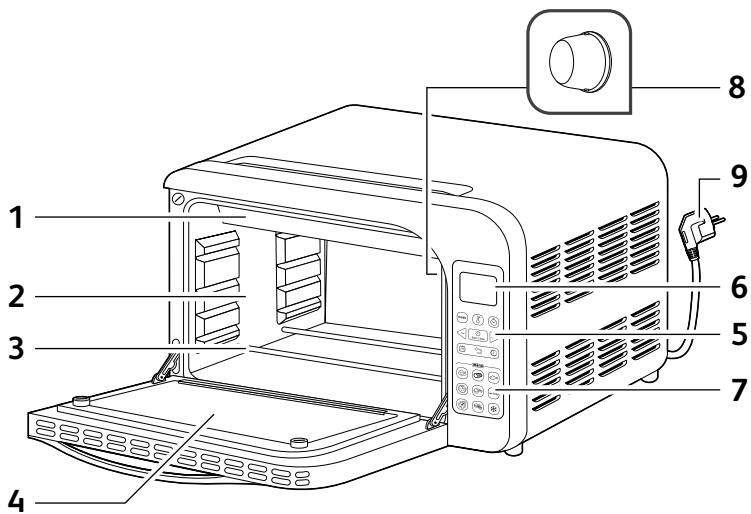

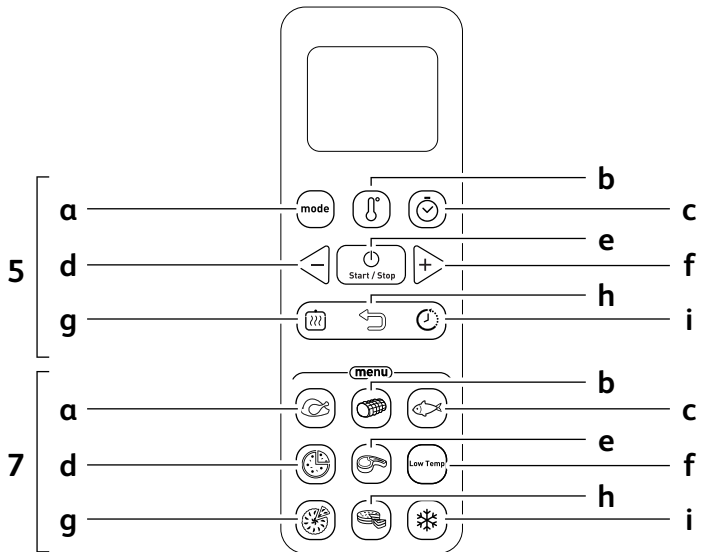
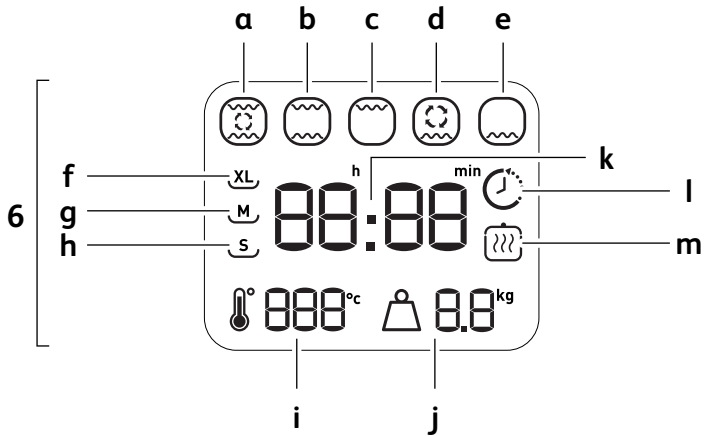

DESCRIPTION

- 1 Éléments chauffants supérieurs
- 2 Parois anti-adhésives
- 3 Éléments chauffants inférieurs
- 4 Porte triple-parois verre
- 5 Panneau de commande
 - a Sélection mode
 - b Sélection température de cuisson
 - c Sélection temps de cuisson / horloge
 - d Bouton selecteur de réglage (<)
 - e Bouton Démarrage / Arrêt de cuisson
 - f Bouton selecteur de réglage (>)
 - g Bouton Maintien au chaud
 - h Bouton annulation
 - i Bouton départ différé
- 6 Afficheur LCD
 - a Mode de cuisson Chaleur Tournante
 - b Mode de cuisson Traditionnel
 - c Mode de cuisson Grill
 - d Mode de cuisson Pâtisserie
 - e Mode de cuisson Bain Marie
 - f Taille de plat XL
 - g Taille de plat M
 - h Taille de plat S
 - i Température
 - j Poids
 - k Affichage temps (Heure / Temps de cuisson / Temps de départ différé)
 - l Départ Différé
 - m Maintien au chaud
- 7 Menus automatiques
 - a Poulet
 - b Rôti
 - c Poisson
 - d Pizza
 - e Grillades
 - f Mode Basse Température
 - g Tarte
 - h Gâteau
 - i Décongélation
- 8 Lampe intérieure
- 9 Cordon d'alimentation
- 10 Grille réversible
- 11 Plat lèche-frite

REGLAGE DE L'HORLOGE

FR

- A la première utilisation, vous pouvez régler l'heure affichée sur votre écran.
- Lorsque vous branchez votre four, l'écran affiche « 00:00^{mm} ». Régler d'abord les heures à l'aide des touches ◀ et ▶ et valider en appuyant sur ⏻. Répéter la même opération pour les minutes.

Note : L'heure ne reste pas en mémoire lorsque le four est débranché. Vous devez répéter cette opération à chaque fois que vous branchez votre four.

DEBALLAGE ET AVANT PREMIERE UTILISATION

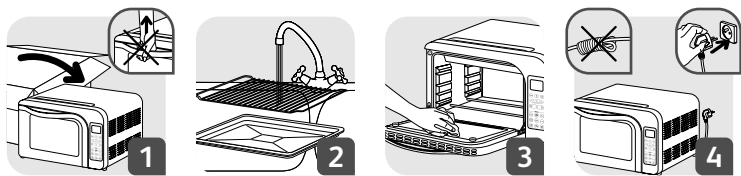

- Sortir le four de son emballage en faisant attention à ne pas le tirer par la poignée (1). Enlever tous les autocollants et protections à l'intérieur et à l'extérieur de votre four. Poser votre four sur une surface stable. Nettoyer les surfaces émaillées ou laquées (2) et la porte (3) avec une éponge humide additionnée de détergent doux. Bien sécher.
- Dérouler le câble et brancher sur une prise électrique reliée à la terre (4).
- Avant la première utilisation il est recommandé de faire chauffer votre four pendant 10 min à température maximale. Pour sortir de l'affichage horloge, et accéder aux réglages des paramètres avant cuisson, appuyer sur la touche (mode). Appuyer sur la touche (mode) jusqu'à sélectionner le mode chaleur tournante (🌀). Appuyer sur la touche (🕒) puis sur ◀ et ▶ jusqu'à afficher la température maximale de 240°C. Ensuite appuyer sur la touche ⏻ le temps par défaut est affiché, utiliser les touches ◀ et ▶ pour arriver au temps recommandé de 10 minutes. Appuyer sur (Start / Stop) pour valider vos réglages et démarrer la chauffe. Le décompte de temps de cuisson s'affiche à l'écran et la lampe intérieure reste allumée.
- Au bout des 10 minutes, le four sonne et l'écran affiche « End ».

UTILISATION MANUELLE



- Pour sortir de l'affichage horloge et accéder aux réglages des paramètres avant cuisson, appuyer sur la touche .

Paramétrage du mode de cuisson

- Pour choisir le mode de cuisson, appuyer sur la touche  jusqu'au mode de cuisson désiré





Paramétrage de la température

- Appuyer sur la touche  la température par défaut s'affiche. Régler la température souhaitée en appuyant sur les touches  et .

Paramétrage du temps de cuisson

- Appuyer sur la touche  le temps par défaut s'affiche. Régler le temps désiré en appuyant sur les touches  et .

Validation

- Pour démarrer votre cuisson, appuyer sur la touche . Pendant la cuisson, la touche  est éclairée, le décompte de temps de cuisson s'affiche à l'écran et la lampe intérieure reste allumée.

Fin de cuisson



- A la fin de la cuisson, si la fonction maintien au chaud n'est pas activée, le four sonne et l'écran affiche « End ».
- Si la fonction maintien au chaud a été activée (voir chapitre maintien au chaud) l'écran affiche le temps de maintien au chaud. Le temps s'incrémente jusqu'à 6 heures maximum.
- **Note :** Vous pouvez modifier la température, le temps, le mode ou activer le maintien au chaud à tout moment pendant la cuisson en appuyant directement sur les touches correspondantes.

Mode Basse Température





Réglage du Mode Basse Température

- Appuyer sur la touche .
- Le témoin lumineux de la touche (Low temp)  s'allume.



Paramétrage du temps de cuisson

- Temps de cuisson par défaut : 2 heures.
- Appuyer sur les touches  et  pour régler le temps de cuisson souhaité. (Il est possible de choisir une durée comprise entre 30 minutes et 4 heures)

Préchauffage

- Appuyer sur la touche  pour démarrer le préchauffage.
- Le témoin lumineux de la touche  reste allumé et s'accompagne d'un long signal sonore.
- La touche  s'allume.
Le préchauffage commence lorsque le voyant  clignote.
- La durée de préchauffage est définie par défaut sur 15 minutes. Lorsque le préchauffage est terminé, 2 bips longs retentissent à nouveau.
- Vous pouvez mettre les aliments dans le four.

Démarrer la cuisson

- Pour commencer la cuisson, appuyer sur la touche .
- Pendant la cuisson, les témoins lumineux des touches  et  sont allumés.
- Le décompte de temps de cuisson s'affiche à l'écran et la lampe intérieure reste allumée.

Définir un nouveau temps de cuisson

- Note : pour régler un nouveau temps de cuisson pendant la cuisson, appuyer sur les touches ,  et .

Fin de cuisson

- À la fin de la cuisson, si la fonction maintien au chaud n'est pas activée, le four émet 3 bips longs et l'écran affiche « **END** ».

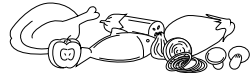

	230g + 300g			15 min	Low Temp.	*35
	250g x2			15 min	Low Temp.	*59
	300g x2			15 min	Low Temp.	*63

Avertissement relatif à la sécurité alimentaire

⚠ ATTENTION : les aliments cuits à basse température ne sont pas pasteurisés et peuvent présenter un risque pour certaines personnes, notamment les femmes enceintes, les jeunes enfants, les personnes âgées ou les personnes immunodéprimées.

Aliments crus :

Achetez vos aliments crus auprès de sources ou de distributeurs réputés et agréés. Si ces ingrédients sont détériorés, contaminés par la saleté, décolorés, malodorants et/ou ont mauvais au goût, ne les utilisez pas. N'oubliez pas de rincer à grande eau les fruits et légumes avant l'utilisation. Respectez les conditions d'utilisation et de conservation avant l'utilisation de ces ingrédients.

Hygiène :



Pour éviter toute contamination par les équipements et les ustensiles, nettoyez-les avant l'utilisation et mettez-les en contact avec les aliments. Nettoyez avec une éponge propre et du liquide vaisselle. Rincez-les bien et laissez-les sécher à l'air. Il est également nécessaire de nettoyer et de désinfecter le plan de travail avant l'utilisation. En outre, lavez-vous les mains minutieusement et régulièrement pour réduire le risque de contamination. N'oubliez pas de vous laver les mains avant de commencer à préparer vos aliments, ainsi que pendant la préparation des aliments crus ou sales (ingrédients avec de la terre). Si vos mains présentent des blessures ou des coupures, assurez-vous de les désinfecter et d'utiliser un pansement approprié avant chaque préparation. Mangez rapidement les repas préparés lorsqu'ils sont prêts.

Votre four dispose de menus pré-programmés : il va déterminer automatiquement le mode, le temps et la température en fonction du poids ou de la taille du plat que vous allez renseigner.

Pour sortir de l'affichage horloge et accéder aux réglages des paramètres avant cuisson, appuyer sur la touche du menu souhaité.









Pour les menus à paramétrage au poids :



- Sélectionner le menu désiré, la touche correspondante s'éclaire. A l'écran le poids clignote, vous devez renseigner celui de votre viande, volaille ou poisson en appuyant sur les touches <←> et <→>. Le temps de cuisson affiché s'adapte automatiquement en fonction du poids choisi. Appuyer sur la touche  pour valider. Selon le menu, le four démarre alors en phase de cuisson, ou en phase de préchauffage. En cas de préchauffage (voir les menus concernés dans le tableau page suivante), un décompte de 10min apparaît à l'écran. Pour un bon résultat en cuisson, il convient d'enfourner le plat uniquement lorsque ce décompte est terminé. Pour cela, attendez le signal de fin de préchauffage (2 bips longs), enfournez alors votre plat et appuyez de nouveau sur  pour démarrer la cuisson.

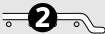
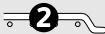
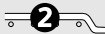
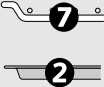

Note : si vous ne confirmez pas la cuisson, celle-ci sera automatiquement annulée au bout de 30 minutes.

Note : Vous pouvez modifier la température, le temps ou le mode à tout moment pendant la cuisson. Vous passez alors en mode manuel. La touche du menu s'éteint mais la cuisson continue selon les paramètres que vous avez modifiés.

Menu					
Plat		Poulet*	Roti	Poisson	Grillade*
Mode					
Position Grille / Plat 					
Température (en °C)		220	240	220	240
Temps de cuisson en min / en fonction du poids (kg)	Préchauffage	Pas de préchauffage	10	10	Pas de préchauffage
	0.2			20	18
	0.3			20	18
	0.4			20	18
	0.5			20	18
	0.6	45	26	21	20
	0.7	50	28	22	22
	0.8	55	30	23	24
	0.9	60	32	24	24
	1	65	34	25	25
	1.1	70	36	26	26
	1.2	75	37	27	27
	1.3	80	38	28	28
	1.4	85	39	29	29
	1.5	90	40	30	30
	1.6	93	42		
	1.7	96	44		
	1.8	99	46		
	1.9	102	48		
	2	105	50		
2.1	108	51			
2.2	111	52			
2.3	114	53			
2.4	117	54			
2.5	120	55			







Pour les menus à paramétrage à la taille :



- Sélectionner le menu désiré, la touche s'éclaire. A l'écran la taille clignote, vous devez renseigner celle de votre pizza, tarte ou gâteau (XL/M/S) en appuyant sur les touches < et >. Le temps de cuisson affiché s'adapte automatiquement en fonction de la taille choisie. Appuyer sur la touche  pour valider. Selon le menu, le four démarre alors en phase de cuisson, ou en phase de préchauffage. En cas de préchauffage (voir les menus concernés dans le tableau ci-dessous), un décompte de 10min apparaît à l'écran. Pour un bon résultat en cuisson, il convient d'enfourner le plat uniquement lorsque ce décompte est terminé. Pour cela, attendez le signal de fin de préchauffage (2 bips longs), enfournez alors votre plat, et appuyez de nouveau sur  pour démarrer la cuisson.

Note : si vous ne confirmez pas la cuisson, celle-ci sera automatiquement annulée au bout de 30 minutes.



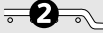
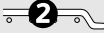
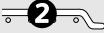

Note : Vous pouvez modifier la température, le temps ou le mode à tout moment pendant la cuisson. Vous passez alors en mode manuel. La touche du menu s'éteint mais la cuisson continue selon les paramètres que vous avez modifiés.

Menu				
Plat		Pizza	Tarte*	Gâteau
Mode				
Position Grille / Plat 				
Température (en °C)		220	220	170
Temps de cuisson en min / en fonction de la taille	Préchauffage	10	Pas de préchauffage	10
	S (de 16 à 22cm)	18	37	20
	M (de 22 à 29cm)	20	38	20
	XL (de 29 à 33cm)	38	40	32





* Départ Différé disponible **11**







Menu Décongélation :







- Appuyer sur la touche Décongélation , le temps par défaut s'affiche. Vous pouvez régler le temps en appuyant sur les touches  et . Démarrer la décongélation de vos aliments en appuyant sur .

Départ différé

- Appuyer sur la touche  puis sur les touches  et  pour régler le temps de votre départ différé. **Il s'agit du temps avant le démarrage de la cuisson et non l'heure de fin de cuisson.** Une fois ce temps réglé, appuyer de nouveau sur  pour l'enregistrer.
- Il est possible ensuite de régler les autres paramètres (mode, temps et température de cuisson) pour cela répéter les instructions du chapitre « Utilisation manuelle ».
- Une fois que vos paramètres sont réglés, appuyer sur  pour lancer le départ différé.
- A la fin du temps de départ différé, la cuisson est lancée automatiquement.

Note : Tant que la cuisson n'est pas lancée, vous pouvez changer votre temps de départ différé. Pour cela, appuyer sur  et réajuster votre valeur à l'aide des touches  et . Appuyer de nouveau sur  ou sur  pour valider ce nouveau temps de départ différé. Il est également possible d'annuler et de revenir sur les paramètres de cuisson sélectionnés, en appuyant sur .

Maintien au chaud

- Si vous souhaitez que votre four passe en maintien au chaud automatiquement après la cuisson, appuyer sur la touche  pendant les étapes de paramétrage de cuisson. Il est également possible de l'activer pendant la cuisson toujours en appuyant sur la touche .
- Le logo  s'affiche à l'écran indiquant que la fonction est activée.
- Pour l'annuler, il vous suffit d'appuyer de nouveau sur la touche .
- Le maintien au chaud s'arrêtera automatiquement au bout de 6 heures, mais il est possible de l'arrêter avant en appuyant sur .

Note : le maintien au chaud ne peut pas être déclenché après une décongélation.

Le maintien au chaud ne peut être déclenché qu'après une cuisson, il ne peut être activé seul.

Problème	Causes possibles	Solution
L'appareil ne fonctionne pas	L'appareil n'est pas bien branché	Vérifier que l'appareil est correctement branché
	L'appareil ne chauffe pas	Apporter l'appareil à un Centre Service Agréé
L'appareil affiche un code erreur E01 à l'écran	Le capteur de température est défaillant	Apporter l'appareil à un Centre Service Agréé
Plus d'éclairage dans la cavité pendant la cuisson	L'ampoule est grillée	Changer l'ampoule (disponible ou auprès d'un Centre Service Agréé).
	Le problème persiste	Apporter l'appareil à un Centre Service Agréé

NETTOYAGE

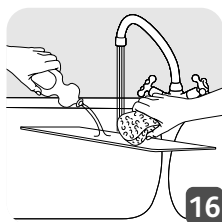
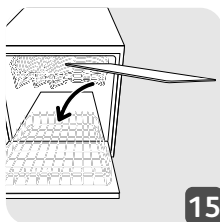
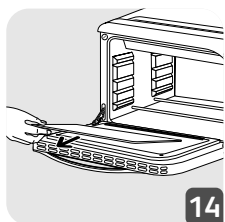
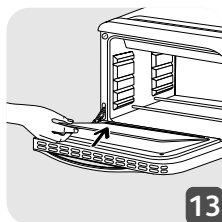
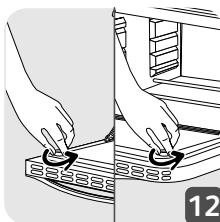
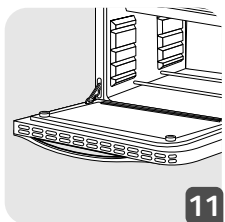
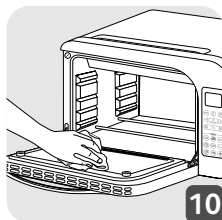
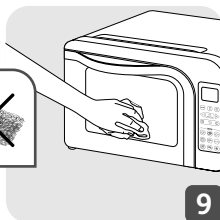
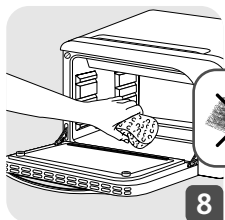
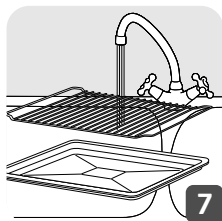
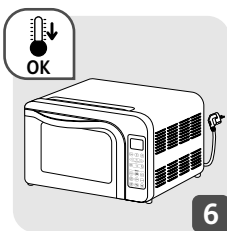
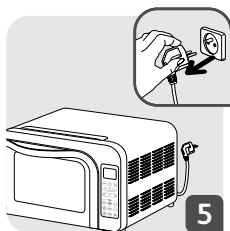

RECOMMANDATIONS

FR

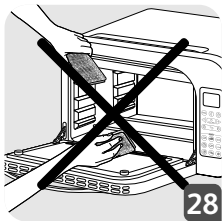
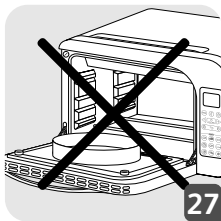
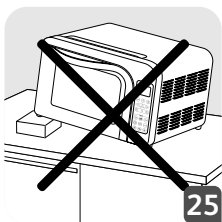
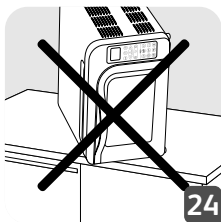
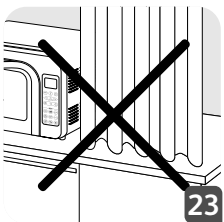
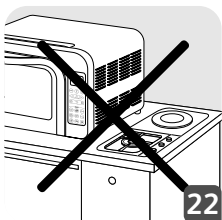
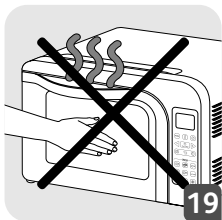

DESCRIPTION

- 1 Upper heating elements
- 2 Non-stick walls
- 3 Lower heating elements
- 4 Triple-walled glass door
- 5 Control panel
 - a Mode selection
 - b Cooking temperature selection
 - c Cooking time / clock selection
 - d Setting Selection button (<)
 - e Cooking Start / Stop button
 - f Setting Selection button (>)
 - g Keep Warm button
 - h Cancel button
 - i Delayed Start button
- 6 LCD display
 - a Convection cooking mode
 - b Traditional cooking mode
 - c Grill cooking mode
 - d Baking cooking mode
 - e Bain-Marie cooking mode
 - f XL dish size
 - g M dish size
 - h S dish size
 - i Temperature
 - j Weight
 - k Time display (time / cooking time / delayed start time)
 - l Delayed start
 - m Keep warm
- 7 Automatic menus
 - a Chicken
 - b Roast
 - c Fish
 - d Pizza
 - e Grill
 - f Low Temp Mode
 - g Pie
 - h Cake
 - i Defrosting
- 8 Inside light
- 9 Power cable
- 10 Reversible grill
- 11 Drip tray



SETTING THE CLOCK

- When using it for the first time, you can set the time displayed on your screen. **EN**
- When you plug in your oven, the screen displays “00:00^{min}”. First adjust the hours using the ◀ and ▶ buttons and confirm by pressing ⏻. Repeat the same process for the minutes.

Please note: The time is not saved when the oven is unplugged. You must repeat this process every time you connect your oven.

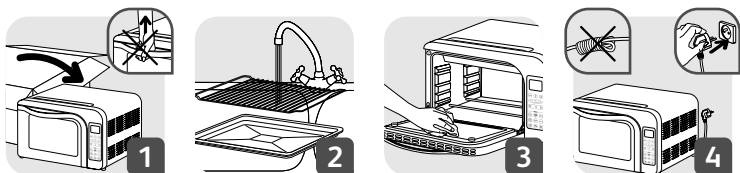
UNPACKING AND USING FOR THE FIRST TIME



- Remove the oven from its packaging, taking care not to pull it by the handle (1). Remove all stickers and protective materials inside and outside your oven. Place your oven on a stable surface. Clean the enamelled or lacquered surfaces (2) and the door (3) with a damp sponge with mild detergent. Dry well.
- Unwind the cable and plug it into an earthed electrical power outlet (4).
- Before using for the first time it is recommended that you heat your oven at the maximum temperature for 10 minutes. To exit the clock display and access the settings before cooking, press the **mode** button. Press the **mode** button until convection cooking mode  is selected. Press the  button then ◀ and ▶ until the maximum temperature of 240°C is displayed. Then press the ⏻ button to display the default time and use the ◀ and ▶ buttons to reach the recommended time of 10 minutes. Press  to confirm your settings and start heating. The cooking time countdown is displayed on the screen and the inside light stays on.
- After 10 minutes the oven sounds and the screen displays “End”.

MANUAL USE



- To exit the clock display and access the settings before cooking, press the  buttons.

Setting the cooking mode



- To choose the cooking mode, press the  button until the desired cooking mode is reached.



Setting the temperature

- Press the  button to display the default temperature. Adjust the desired temperature by pressing the  and  buttons.

Setting the cooking time

- Press the  button to display the default time. Adjust the desired time by pressing the  and  buttons.

Validation

- To start cooking, press the  button. During cooking, the  button is lit up, the cooking time countdown is displayed on the screen and the inside light stays on.

End of cooking



- At the end of cooking, if the keep warm function is not activated, the oven sounds and the screen displays “End”.
- If the keep warm function has been activated (see ‘Keep warm’ chapter) the screen displays the time for keeping warm. The time is in increments up to a maximum of 6 hours.
- **Please note: You can change the temperature, time, mode or activate the keep warm setting at any time during cooking by pressing the corresponding buttons directly.**

Low Tempe Mode





Setting the Low Temp mode

- Press  button
-  button light is ON



Setting the cooking time

- Default 2 hour cooking time
- Press the  and  button to adjust the desired cooking time. (Can choose time between 30min and 4hr).



Preheating

- Press the  button to start the Preheating.
-  button light stays on and accompanied by 1 long beep sound.
-  button is ON
 flashing means preheating
- Preheating time defaulted 15mins, when preheating is finished, 2 long beeps will sound again.
- You can put the food into the oven.

Start the Cooking

- To start cooking, press the  button.
- During cooking, the  and  buttons are light on.
- The cooking time countdown is displayed on the screen and the inside light stays on.

Set New Time

- Please note: During cooking, if you want to set a new time, press 
 and  button to set up new cooking time;

End of cooking

- At the end of cooking, if the keep warm function is not activated, the oven sound 3 long beeps and the screen displays “End”.

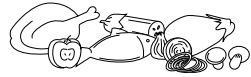

	230g + 300g	Low Temp		15 min	Low Temp.	*35
	250g x2	Low Temp		15 min	Low Temp.	*59
	300g x2	Low Temp		15 min	Low Temp.	*63

Food Safety warning

⚠ CAUTION: foods are not pasteurized under low temperature and may pose a risk to certain individuals. These individuals include pregnant women, young children, the elderly or otherwise immunocompromised.

Raw material:

Purchase your raw materials from known and approved sources or distributors. If you notice any deterioration, contamination by dirt, discoloration or bad smell and / or taste, do not use these ingredients. Remember to rinse with plenty of water fruits and vegetables before use. Respect the conditions of use and conservation before use of these raw materials.

Hygiene:

To prevent contamination by equipment and utensils, clean them before use and put in contact with food. Clean with a clean sponge and dishwashing liquid. Then rinse them well and leave to dry in the air. It is also necessary to clean and disinfect the worktop before use. In addition, regular and careful hand hygiene reduces the risk of contamination. Remember to wash your hands before starting to prepare food, as well as during preparation for raw or soiled foods (plants with soil). If there are any wounds or cuts on the hands, be sure to disinfect and put on a suitable dressing before each food preparation. Eat prepared meals quickly when they are ready.

USE OF AUTOMATIC MENUS



EN

Your oven has pre-programmed menus: it will automatically determine the mode, time and temperature according to the weight or size of the dish that you enter.

To exit the clock display and access the settings before cooking, press the menu button desired.









For menus with weight setting:



- Select the desired menu and the corresponding button lights up. The weight flashes on the screen and you have to enter the weight of your meat, poultry or fish by pressing the < and > keys. The cooking time displayed adjusts automatically according to the weight selected. Press the  button to confirm. Depending on the menu, the oven starts in cooking phase or in preheating phase. In the case of preheating (see the relevant menus in the table on the following page), a countdown of 10 minutes appears on the screen. For good cooking results, the dish should only be put in the oven when this countdown is complete. To do this, wait for the end of preheating signal (2 long beeps), then put your dish in the oven and press  again to start cooking.

Note: if you do not confirm the cooking, it will be automatically cancelled after 30 minutes.

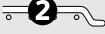
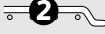
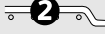
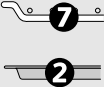

Please note: You can change the temperature, the time or the mode at any time during cooking. You then switch to manual mode. The menu button goes off but the cooking continues according to the settings you have changed.

Menu					
Dish		Chicken*	Roast	Fish	Grill*
Mode					
Grill/Dish position 					
Temperature (in °C)		220	240	220	240
Cooking time in minutes / according to weight (kg)	Preheating	No preheating	10	10	No preheating
	0.2			20	18
	0.3			20	18
	0.4			20	18
	0.5			20	18
	0.6	45	26	21	20
	0.7	50	28	22	22
	0.8	55	30	23	24
	0.9	60	32	24	24
	1	65	34	25	25
	1.1	70	36	26	26
	1.2	75	37	27	27
	1.3	80	38	28	28
	1.4	85	39	29	29
	1.5	90	40	30	30
	1.6	93	42		
	1.7	96	44		
	1.8	99	46		
	1.9	102	48		
	2	105	50		
2.1	108	51			
2.2	111	52			
2.3	114	53			
2.4	117	54			
2.5	120	55			

For menus with size setting:









EN

- Select the desired menu and the button lights up. The size flashes on the screen and you have to enter the size of your pizza, pie or cake (XL/M/S) by pressing the < and > keys. The cooking time displayed adjusts automatically according to the weight selected. Press the  button to confirm. Depending on the menu, the oven starts in cooking phase or in preheating phase. In the case of preheating (see the relevant menus in the table below), a countdown of 10 minutes appears on the screen. For good cooking results, the dish should only be put in the oven when this countdown is complete. To do this, wait for the end of preheating signal (2 long beeps), then put your dish in the oven and press  again to start cooking.

Note: if you do not confirm the cooking, it will be automatically cancelled after 30 minutes.



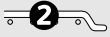
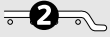
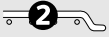

Please note: You can change the temperature, the time or the mode at any time during cooking. You then switch to manual mode. The menu button goes off but the cooking continues according to the settings you have changed.

Main				
Dish		Pizza	Pie*	Cake
Mode				
Grill/Dish position 				
Temperature (in °C)		220	220	170
Cooking time in minutes / according to size	Preheating	10	No preheating	10
	S (from 16 to 22cm)	18	37	20
	M (from 22 to 29cm)	20	38	20
	XL (from 29 to 33cm)	38	40	32





* Delayed start available







Defrost Menu:







- Press the Defrost button  to display the default time. You can set the time by pressing the keys  and . Start defrosting your food by pressing .

Delayed start

- Press the  button then the  and  buttons to adjust the time of your delayed start. **This is the time before the cooking starts and not the end of the cooking time.** Once this time has been set, press  again to save it.
- It is then possible to set the other settings (mode, time and temperature of cooking) by repeating the instructions in the chapter "Manual Use".
- Once your settings are set, press  to launch the delayed start.
- At the end of the delayed start time, cooking is started automatically.

Please note: As long as the cooking has not started, you can change your delayed start time. To do this, press  and reset your value using the  and  keys. Press again on  or  to confirm this new delayed start time. It is also possible to cancel and return to the cooking settings selected, by pressing .

Keep warm

- If you want your oven to go into Keep Warm mode automatically after cooking, press the  key during the cooking setting steps. It can also be activated during cooking by pressing the  button.
- The  logo appears on the screen indicating that the function is activated.
- To cancel it, simply press the  button again.
- Keep Warm mode will stop automatically after 6 hours, but it can be stopped before by pressing .

Note: the Keep Warm mode can not be set for after defrosting. Keep Warm mode can only be set for after cooking, it cannot be activated alone.

Problem	Possible causes	Solution
The appliance does not work	The appliance is not properly plugged in	Verify that the appliance is correctly plugged in
	The appliance does not heat	Take the appliance to an Authorised Service Centre
The appliance displays an error code E01 on the screen	The temperature sensor is faulty	Take the appliance to an Authorised Service Centre
No lighting in the oven cavity during cooking	The light bulb has burned out	Change the light bulb (available from an Authorised Service Centre).
	The problem persists	Take the appliance to an Authorised Service Centre

CLEANING

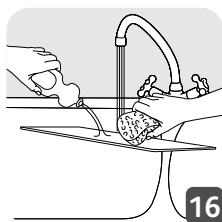
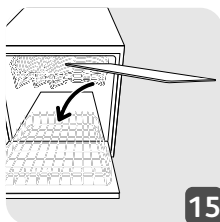
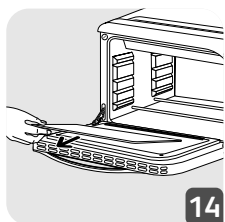
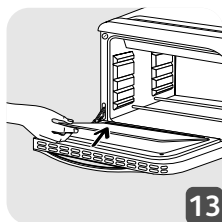
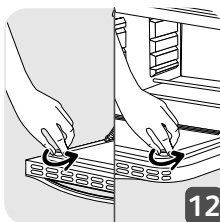
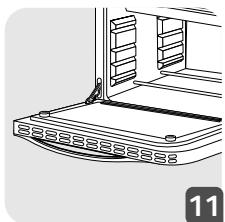
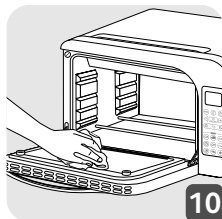
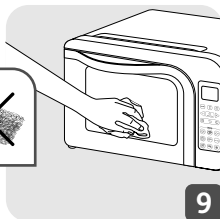
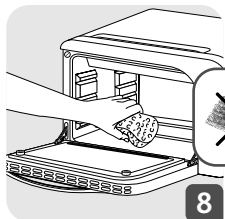
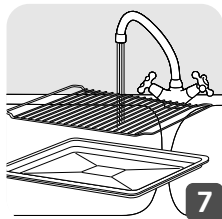
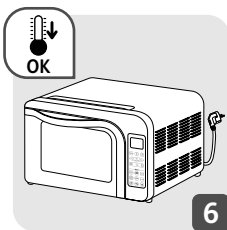
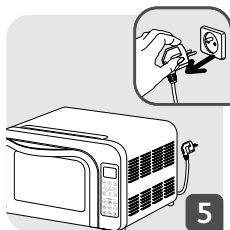

RECOMMENDATIONS

EN

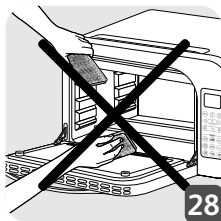
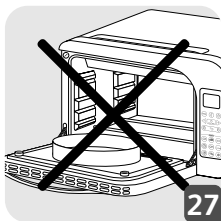
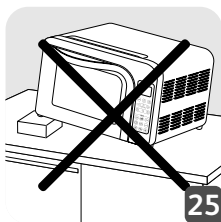
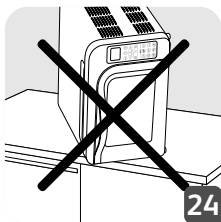
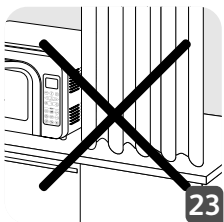
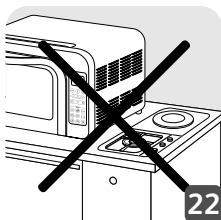
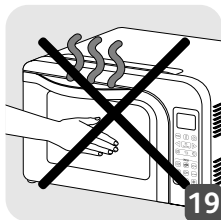

27

BESCHRIJVING

- 1 Bovenste verwarmingselementen
- 2 Wanden met antiaanbaklaag
- 3 Onderste verwarmingselementen
- 4 Driedubbelwandige glazen deur
- 5 Bedieningspaneel
 - a Keuze van modus
 - b Keuze van baktemperatuur
 - c Keuze van baktijd / klok
 - d Instelknop (<)
 - e Start/Stop knop
 - f Instelknop (>)
 - g Warm houden knop
 - h Annuleren knop
 - i Startuitstel knop
- 6 LCD-scherm
 - a Bakmodus Hetelucht
 - b Bakmodus Traditioneel
 - c Bakmodus Grill
 - d Bakmodus Gebak
 - e Bakmodus Bain-marie
 - f Grootte van gerecht XL
 - g Grootte van gerecht M
 - h Grootte van gerecht S
 - i Temperatuur
 - j Gewicht
 - k Weergave van tijden (Huidige tijd/ Baktijd/ Startuitsteltijd)
 - l Startuitstel
 - m Warm houden
- 7 Automatische menu's
 - a Kip
 - b Gebraad
 - c Vis
 - d Pizza
 - e Geroosterd vlees
 - f lage temperatuur modus
 - g Taart
 - h Gebak
 - i Ontdooien
- 8 Binnenverlichting
- 9 Snoer
- 10 Omkeerbaar rooster
- 11 Opvangbak voor vet

DE KLOK INSTELLEN

- Bij ingebruikname van de oven is het mogelijk om de tijd die op het scherm wordt weergegeven in te stellen.
- Als u de stekker in het stopcontact steekt, wordt “00:00” op het scherm weergegeven. Stel het juiste uur in met de knop ◀ en ▶, en bevestig door op ⌚ te drukken. Voer dezelfde handeling uit om de minuten in te stellen.

NL

Opmerking: De tijd wordt niet opgeslagen wanneer de stekker uit het stopcontact wordt gehaald. U moet deze handeling uitvoeren telkens u de oven op de voeding aansluit.

UITPAKKEN EN VOOR INGEBRUIKNAME

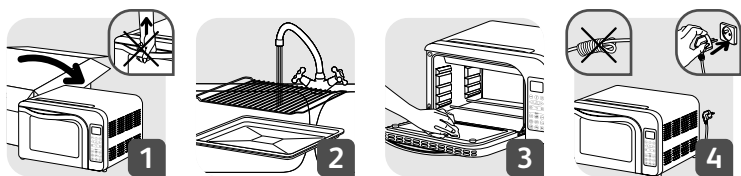

- Haal de oven uit de verpakking. Doe dit niet door aan het handvat (1) te trekken. Verwijder alle etiketten en alle beschermingsmateriaal aan de binnen- en buitenkant van uw oven. Plaats uw oven op een stabiel oppervlak. Maak de geëmailleerde of gelakte oppervlakken (2) en de deur (3) schoon met een vochtige spons en een beetje afwasmiddel. Wrijf goed droog.
- Wikkel het snoer af en steek de stekker in een geaard stopcontact (4).
- Het is voor ingebruikname aanbevolen om uw oven gedurende 10 minuten op de maximum temperatuur te laten werken. Om de weergave van de tijd af te sluiten en de instellingen voor het bakproces te openen, druk op de knop (mode). Druk op de knop (mode) totdat de modus Hetelucht (☼) is geselecteerd. Druk op de knop (⏸) en vervolgens op ◀ en ▶ totdat de maximum temperatuur van 240°C wordt weergegeven. Druk vervolgens op de knop ⌚ en de standaard tijd wordt weergegeven. Gebruik de knoppen ◀ en ▶ om de aanbevolen tijd van 10 minuten te bereiken. Druk op (Start/Stop) om uw instellingen te bevestigen en de oven start met opwarmen. De resterende baktijd wordt op het scherm weergegeven en de binnenverlichting blijft branden.

- Na het verstrijken van de 10 minuten hoort u een geluidssignaal en verschijnt “End” op het scherm.

HANDMATIGE BEDIENING



- Om de weergave van de klok af te sluiten en de instellingen voor het bakproces te openen, druk op de knop .

De bakmodus instellen

- Om de gewenste bakmodus te kiezen, druk herhaaldelijk op de knop .





De temperatuur instellen

- Druk op de knop  en de standaard temperatuur wordt weergegeven. Stel de gewenste temperatuur in door op de knop  en  te drukken.

De baktijd instellen

- Druk op de knop  en de standaard tijd wordt weergegeven. Stel de gewenste tijd in door op de knop  en  te drukken.

Bevestigen

- Om het bakproces te starten, druk op de knop . Tijdens het bakproces is de knop  verlicht, wordt de resterende baktijd op het scherm weergegeven en blijft de binnenverlichting branden.

Einde van bakproces

- Aan het einde van het bakproces, en wanneer de warmhoudfunctie niet actief is, hoort u een geluidssignaal en verschijnt “End” op het scherm.
- Als de warmhoudfunctie geactiveerd is (zie hoofdstuk “Warm houden”), geeft het scherm de warmhoudtijd weer. De tijd neemt toe, tot maximaal 6 uur.

Opmerking: U kunt op elk moment tijdens het bakproces de temperatuur, de tijd of de modus aanpassen of de warmhoudfunctie activeren door direct op de overeenkomstige knoppen te drukken.



Lage Temperatuur Modus

De modus voor lage temperatuur instellen





- Drop op de knop 
- Het lampje van de knop  is AAN

NL



De bereidingstijd instellen

- Standaard bereidingstijd van 2 uur
- Druk op de knop  of  om de gewenste bereidingstijd aan te passen. (Keuze tussen minimaal 30 minuten en maximaal 4 uur)



Voorverwarmen

- Drop op de knop  om het voorverwarmen te starten
- Het lampje van de knop  blijft branden en er klinkt één lange pieptoon.
-  is AAN
Als  knippert, wordt het apparaat voorverwarmd.
- Voorverwarmen duurt standaard 15 minuten. Als het voorverwarmen is voltooid, klinken er twee lange pieptonen.
- U kunt eten in de oven doen

Begin de bereiding

- Druk op de knop  om de bereiding te starten
- Tijdens de bereiding branden de lampjes van de knoppen  en 
- De resterende tijd wordt weergegeven op het scherm en het lampje aan de binnenkant blijft branden

Een nieuwe tijd instellen

- Let op: Als u tijdens de bereiding een nieuwe tijd wilt instellen, drukt u op de knoppen   en .

Bereiding klaar

- Als de bereiding is voltooid en de warmhoudfunctie niet is ingeschakeld, klinken er drie lange pieptonen en staat er 'END' (KLAAR) op het scherm.

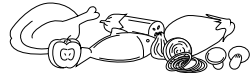

	230g + 300g	Low Temp		15 min	Low Temp.	*35
	250g x2	Low Temp		15 min	Low Temp.	*59
	300g x2	Low Temp		15 min	Low Temp.	*63

Waarschuwing voedselveiligheid

⚠️ PAS OP: voedingsmiddelen worden niet gepasteuriseerd bij lage temperaturen en kunnen voor sommige mensen een risico vormen. Dit omvat zwangere vrouwen, jonge kinderen, ouderen of anderen met een aangetast immuunsysteem.

Rauwe ingrediënten:

Koop uw rauwe ingrediënten bij erkende en goedgekeurde bronnen of distributeurs. Als u aantasting, besmetting met vuil of verkleuring ziet, of als u een bedorven geur of smaak ruikt of proeft, gebruik het ingrediënt dan niet. Spoel fruit en groenten voor gebruik grondig af met water. Neem de voorwaarden voor gebruiken en bewaren in acht voordat u de rauwe ingrediënten gebruikt.

Hygiëne:

U dient uw kookgerei en bestek voorafgaand aan contact met het voedsel te reinigen, om besmetting te voorkomen. Reinig met een schone spons en afwasmiddel. Spoel vervolgens af en laat drogen aan de lucht. Reinig en desinfecteer ook het aanrechtblad of werkblad voor gebruik. Daarnaast vermindert u de kans op besmetting door regelmatig en zorgvuldig uw handen te wassen. Was uw handen voordat u het voedsel bereidt en tijdens het bereiden van rauwe ingrediënten of ingrediënten uit de aarde. Als u wonden of sneden op uw handen hebt, desinfecteer deze dan en voorzie ze van een geschikt verband voordat u voedsel bereidt. Wacht na het bereiden van maaltijden niet te lang met het opeten.

DE AUTOMATISCHE MENU'S GEBRUIKEN



Uw oven is voorzien van vooraf ingestelde menu's: de oven zal aldus automatisch de modus, baktijd en temperatuur bepalen afhankelijk van het gewicht of de grootte van het gerecht dat u wilt bereiden.

NL

Om de weergave van de klok af te sluiten en de instellingen voor het bakproces te openen, druk op de gewenste menuknop.













Voor menu's die op gewicht worden ingesteld:



- Kies het gewenste menu en de overeenkomstige knop wordt verlicht. Het gewicht knippert op het scherm. Geef vervolgens het gewicht van het te bereiden vlees, gevogelte of vis in door op de knop \leftarrow en \rightarrow te drukken. De weergegeven baktijd wijzigt automatisch naargelang het gekozen gewicht. Druk op de knop  om te bevestigen. Afhankelijk van het menu wordt de oven in de kook- of voorverwarmingsfase ingeschakeld. In de voorverwarmingsfase (zie de relevante menu's in de tabel op de volgende bladzijde) verschijnt er een timer van 10 minuten op het scherm. Voor een goed kookresultaat, zet het gerecht pas in de oven eenmaal de timer nul heeft bereikt. Om dit te doen, wacht op het eindsignaal van de voorverwarmingsfase (2 lange pieptonen), zet uw gerecht vervolgens in de oven en druk opnieuw op  om het kookproces te starten.

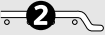
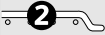

Opmerking: Als u het kookproces niet bevestigt, wordt het automatisch na 30 minuten geannuleerd.

Opmerking: U kunt op elk moment tijdens het bakproces de temperatuur, de tijd of de modus wijzigen. De handmatige modus wordt vervolgens geopend. De knop van het menu wordt niet langer verlicht, maar het bakproces gaat verder volgens de door u aangepaste parameters.

Menu					
Gerecht		Kip*	Gebraad	Vis	Geroosterd vlees*
Modus					
Positie van rooster / gerecht					 
Temperatuur (in °C)		220	240	220	240
Baktijd in min / op gewicht (kg)	Voorverwarmen	Geen voorverwarming	10	10	Geen voorverwarming
	0,2			20	18
	0,3			20	18
	0,4			20	18
	0,5			20	18
	0,6	45	26	21	20
	0,7	50	28	22	22
	0,8	55	30	23	24
	0,9	60	32	24	24
	1	65	34	25	25
	1,1	70	36	26	26
	1,2	75	37	27	27
	1,3	80	38	28	28
	1,4	85	39	29	29
	1,5	90	40	30	30
	1,6	93	42		
	1,7	96	44		
	1,8	99	46		
	1,9	102	48		
	2	105	50		
2,1	108	51			
2,2	111	52			
2,3	114	53			
2,4	117	54			
2,5	120	55			







Voor menu's die op grootte worden ingesteld:



- Kies het gewenste menu en de knop wordt verlicht. De grootte knippert op het scherm. Geef vervolgens de grootte van de te bereiden pizza, taart of gebak (XL/M/S) in door op de knop \leftarrow en \rightarrow te drukken. De weergegeven baktijd wijzigt automatisch naargelang de gekozen grootte. Druk op de knop  om te bevestigen. Afhankelijk van het menu wordt de oven in de kook- of voorverwarmingsfase ingeschakeld. In de voorverwarmingsfase (zie de relevante menu's in onderstaande tabel) verschijnt er een timer van 10 minuten op het scherm. Voor een goed kookresultaat, plaats het gerecht pas in de oven eenmaal de timer nul heeft bereikt. Om dit te doen, wacht op het eindsignaal van de voorverwarmingsfase (2 lange pieptonen), zet uw gerecht vervolgens in de oven en druk opnieuw op  om het kookproces te starten.

NL

Opmerking: U kunt op elk moment tijdens het bakproces de temperatuur, de tijd of de modus wijzigen. De handmatige modus wordt vervolgens geopend. De knop van het menu wordt niet langer verlicht, maar het bakproces gaat verder volgens de door u aangepaste parameters.

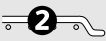
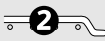
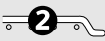

Menu			
Gerecht	Pizza	Taart*	Gebak
Modus			
Positie van rooster / gerecht 			
Temperatuur (in °C)	220	220	170

* Uitgestelde start beschikbaar





Baktijd in min / op grootte	Voorverwarmen	10	Geen voorverwarming	10
	S (tussen 16 en 22cm)	18	37	20
	M (tussen 22 en 29cm)	20	38	20
	XL (tussen 29 en 33cm)	38	40	32







Ontdooimenu:







- Druk op de ontdooinop  en de standaard temperatuur wordt weergegeven. Stel de tijd in door op de knop  en  te drukken. Druk op  om het ontdooien van uw levensmiddelen te starten.

Startuitletstel

- Druk op de knop  en vervolgens op de knop  en  om de startuitletsteltijd in te stellen. **Deze tijd is de starttijd van het bakproces en niet de eindtijd.** Eenmaal de tijd is ingesteld, druk opnieuw op  om in het geheugen op te slaan.
- U kunt vervolgens de andere parameters (bakmodus, -tijd en -temperatuur) instellen, raadpleeg hiervoor het hoofdstuk “Handmatige bediening”.
- Eenmaal alle parameters zijn ingesteld, druk op  om de startuitletstel te activeren.
- Na het verstrijken van de startuitletsteltijd wordt de oven automatisch ingeschakeld.

Opmerking: Zolang het kookproces niet gestart is, is het mogelijk om de startuitletsteltijd te wijzigen. Om dit te doen, druk op  en stel uw nieuwe tijd in met de knop  en . Druk opnieuw op  of  om de nieuwe startuitletsteltijd te bevestigen. Het is tevens mogelijk om het kookproces te annuleren en naar de gekozen kookinstellingen terug te gaan door op  te drukken.

Warm houden

- Als u uw oven na het bakproces warm wilt houden, druk tijdens het instellen van het bakproces op de knop . Het is tevens mogelijk om de warmhoudfunctie tijdens het bakproces te activeren door op de knop  te drukken.
- Het logo  verschijnt op het scherm om aan te geven dat de warmhoudfunctie actief is.
- Om deze functie te annuleren, druk opnieuw op de knop .
- De warmhoudfunctie wordt automatisch na 6 uur uitgeschakeld. U kunt deze functie echter vroegtijdig uitschakelen door te drukken op



Opmerking: de warmhoudfunctie kan niet worden gestart na een ontdooiproces.

De warmhoudfunctie kan alleen na een bakproces worden gestart, deze kan niet afzonderlijk worden geactiveerd.

Probleem	Mogelijke oorzaken	Oplossing
Het apparaat werkt niet	De stekker zit niet goed in het stopcontact	Controleer of de stekker goed in het stopcontact zit
	Het apparaat warmt niet op	Breng het apparaat naar een erkend servicecentrum
De foutcode E01 verschijnt op het scherm	De temperatuursensor is defect	Breng het apparaat naar een erkend servicecentrum
Geen verlichting in de oven tijdens het kookproces	De lamp is stuk	Vervang de lamp (beschikbaar in een erkend servicecentrum)
	Het probleem houdt aan	Breng het apparaat naar een erkend servicecentrum

REINIGUNG

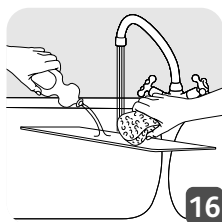
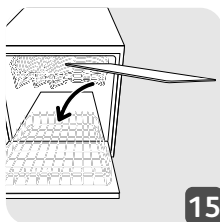
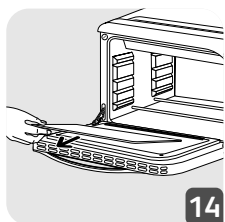
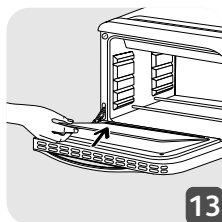
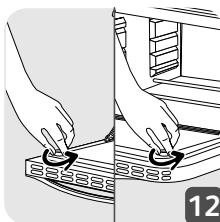
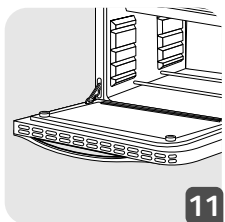
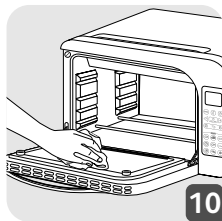
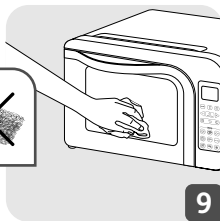
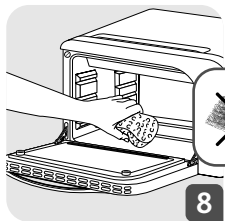
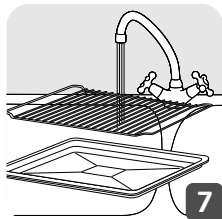
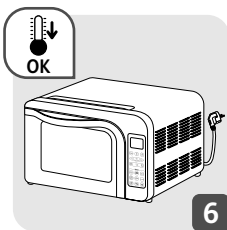
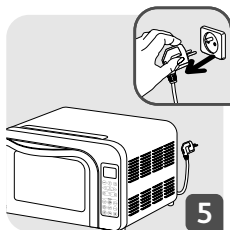

AANBEVELINGEN

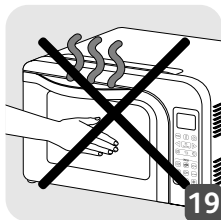

NL

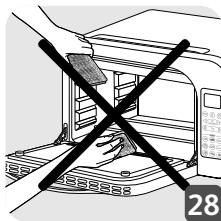
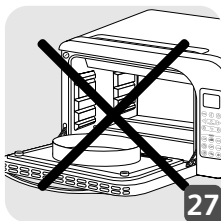
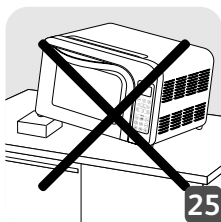
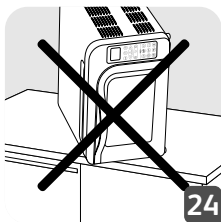
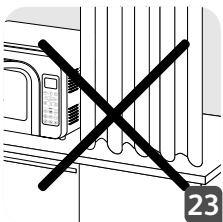
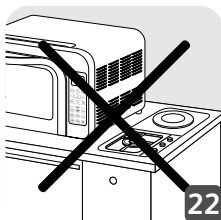

DESCRIZIONE

- 1 Elementi riscaldanti superiori
- 2 Pareti antiaderenti
- 3 Elementi riscaldanti inferiori
- 4 Porta in vetro a tre pareti
- 5 Pannello di controllo
 - a Selezione della modalità
 - b Selezione della temperatura di cottura
 - c Tempo di cottura / selezione dell'orologio
 - d Pulsante di selezione delle impostazioni (<)
 - e Pulsante di avvio/arresto cottura
 - f Pulsante di selezione delle impostazioni (>)
 - g Pulsante di mantenimento in caldo
 - h Pulsante Annulla
 - i Pulsante Avvio ritardato
- 6 Display LCD
 - a Modalità di cottura a convezione
 - b Modalità di cottura tradizionale
 - c Modalità di cottura con grill
 - d Modalità cottura in forno
 - e Modalità di cottura a bagnomaria
 - f Dimensione piatto XL
 - g Dimensione piatto M
 - h Dimensione piatto S
 - i Temperatura
 - j Peso
 - k Visualizzazione tempo (ora / tempo di cottura / tempo di inizio ritardato)
 - l Avvio ritardato
 - m Mantenimento in caldo
- 7 Menu automatici
 - a Pollo
 - b Arrosto
 - c Pesce
 - d Pizza
 - e Grill
 - f Modalità bassa temperatura
 - g Sformato
 - h Torta
 - i Scongellamento
- 8 Luce interna
- 9 Cavo di alimentazione
- 10 Grill reversibile
- 11 Vassoio raccogliocce

IMPOSTAZIONE DELL'OROLOGIO

- Quando lo si utilizza per la prima volta, è possibile impostare l'ora visualizzata sullo schermo.
- Quando si collega il forno, sullo schermo viene visualizzato "00:00". Regolare innanzitutto le ore utilizzando i pulsanti ◀ e ▶ e confermare premendo ⌚. Ripetere la stessa procedura per i minuti.

Nota: il tempo non viene salvato quando si scollega il forno. È necessario ripetere questa procedura ogni volta che si collega il forno.

DISIMBALLAGGIO E UTILIZZO PER LA PRIMA VOLTA

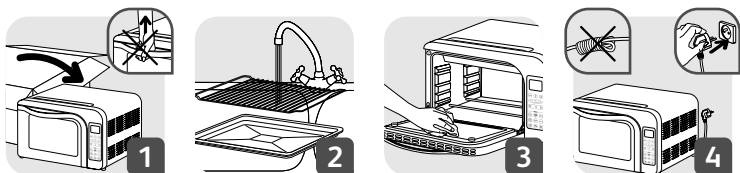

- Estrarre il forno dalla confezione, facendo attenzione a non tirarlo per la maniglia (1). Rimuovere tutti gli adesivi e i materiali di protezione all'interno e all'esterno del forno. Posizionare il forno su una superficie stabile. Pulire le superfici smaltate o laccate (2) e lo sportello (3) con una spugna umida e un detergente delicato. Asciugare bene.
- Srotolare il cavo e collegarlo a una presa elettrica con messa a terra (4).
- Prima di utilizzarlo per la prima volta, si consiglia di riscaldare il forno alla temperatura massima per 10 minuti. Per uscire dal display dell'orologio e accedere alle impostazioni prima della cottura, premere il pulsante **mode**. Premere il pulsante **mode** fino a selezionare la modalità di cottura a convezione **⊞**. Premere il pulsante **⌚**, quindi ◀ e ▶ fino a visualizzare la temperatura massima di 240 °C. Quindi premere il pulsante ⌚ per visualizzare l'ora predefinita e utilizzare i pulsanti ◀ e ▶ per raggiungere il tempo consigliato di 10 minuti. Premere **Start/Stop** per confermare le impostazioni e avviare il riscaldamento. Sullo schermo viene visualizzato il conto alla rovescia del tempo di cottura e la luce interna rimane accesa.
- Dopo 10 minuti, il forno suona e sullo schermo viene visualizzato "End" (Fine).

USO MANUALE



- Per uscire dal display dell'orologio e accedere alle impostazioni prima della cottura, premere i pulsanti .

Impostazione della modalità di cottura

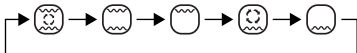

- Per scegliere la modalità di cottura, premere il  pulsante fino a raggiungere la modalità di cottura desiderata.





Impostazione della temperatura

- Premere il pulsante  per visualizzare la temperatura predefinita. Regolare la temperatura desiderata premendo i pulsanti  e .

Impostazione del tempo di cottura

- Premere il pulsante  per visualizzare il tempo predefinito. Regolare il tempo desiderato premendo i pulsanti  e .

Convalida



- Per iniziare la cottura, premere il pulsante . Durante la cottura, il pulsante  è acceso, il conto alla rovescia del tempo di cottura viene visualizzato sullo schermo e la luce interna rimane accesa.

Fine cottura



- Al termine della cottura, se la funzione di mantenimento in caldo non è attivata, il forno emette un segnale acustico e sullo schermo viene visualizzato "End" (Fine).
- Se la funzione di mantenimento in caldo è stata attivata (vedere il capitolo "Mantenimento in caldo"), sullo schermo viene visualizzato il tempo per mantenere in caldo. Il tempo è in incremento fino a un massimo di 6 ore.
- **Nota: è possibile modificare la temperatura, il tempo, la modalità o attivare l'impostazione di mantenimento in caldo in qualsiasi momento durante la cottura premendo direttamente i pulsanti corrispondenti.**

Low Tempe Mode



Impostazione della temperatura bassa

- Premere il pulsante 
- Il pulsante  si accende

Impostazione del tempo di cottura

- Tempo di cottura predefinito 2 ore
- Premere i pulsanti  e  per regolare il tempo di cottura desiderato. (È possibile selezionare il tempo di cottura tra 30 min e 4 h)



Preriscaldamento

- Premere il pulsante  per avviare il preriscaldamento
- Il pulsante  rimane acceso e viene emesso un segnale acustico lungo
- Il pulsante  si accende



L'indicatore  lampeggia quando si avvia il preriscaldamento

- La fase di preriscaldamento è preimpostata a 15 minuti; al termine del preriscaldamento, verranno emessi nuovamente 2 segnali acustici lunghi.
- È possibile inserire il cibo nel forno.

Avvio cottura

- Per avviare la cottura, premere il pulsante .
- Durante la cottura, i pulsanti  e  sono accesi.
- Il conto alla rovescia del tempo di cottura viene visualizzato sullo schermo e la luce interna rimane accesa.

Impostazione del nuovo tempo di cottura

- Nota: Durante la cottura, se si desidera impostare un nuovo tempo di cottura, premere il pulsanti ,  e .

Termine della cottura

- Al termine della cottura, se la funzione di mantenimento in caldo non è attivata, il forno emette 3 segnali acustici lunghi e sullo schermo viene visualizzato «END»(Fine).



	230g + 300g			15 min	Low Temp.	*35
	250g x2			15 min	Low Temp.	*59
	300g x2			15 min	Low Temp.	*63

Avvertenza per la sicurezza alimentare

⚠ ATTENZIONE: gli alimenti non vengono pastorizzati a bassa temperatura e possono rappresentare un rischio per alcune categorie di persone. Queste categorie includono donne in stato di gravidanza, bambini, anziani o soggetti immunodepressi.

Materie prime:

Acquistare le materie prime da fonti o distributori conosciuti e sicuri. Se si notano tracce di deterioramento, contaminazione da sporcizia, scolorimento o cattivo odore e/o sapore, non usare questi ingredienti. Ricordarsi di risciacquare abbondantemente con acqua frutta e verdura prima dell'uso. Rispettare le condizioni d'uso e di conservazione prima di utilizzare queste materie prime.

Igiene:

Per evitare la contaminazione da parte di apparecchiature e utensili, pulirli prima dell'uso e prima che entrino in contatto con gli alimenti. Pulire con una spugna pulita e un detergente liquido per lavastoviglie. Quindi, risciacquarli bene e lasciarli asciugare all'aria. È inoltre necessario pulire e disinfettare il piano di lavoro prima dell'uso. La regolare e accurata pulizia delle mani riduce altresì il rischio di contaminazione. Ricordarsi di lavare le mani prima di iniziare a preparare il cibo e durante la preparazione di cibi crudi o sporchi (vegetali con terriccio). In caso di ferite o tagli sulle mani, disinfettare e applicare una medicazione adeguata prima di ogni preparazione alimentare. Consumare in tempi brevi i cibi preparati.

USO DEI MENU AUTOMATICI



IT

Il forno dispone di menu preprogrammati: determina automaticamente la modalità, il tempo e la temperatura in base al peso o alle dimensioni del piatto inserito.

Per uscire dal display dell'orologio e accedere alle impostazioni prima della cottura, premere il pulsante del menu desiderato.









Per i menu con impostazione del peso:



- Selezionare il menu desiderato e il pulsante corrispondente si accende. Il peso lampeggia sullo schermo ed è necessario immettere il peso della carne, del pollame o del pesce premendo i tasti < e >. Il tempo di cottura visualizzato si regola automaticamente in base al peso selezionato. Premere il pulsante  per confermare. A seconda del menu, il forno si avvia in fase di cottura o in fase di preriscaldamento. In caso di preriscaldamento (vedere i relativi menu nella tabella alla pagina seguente), sullo schermo viene visualizzato un conto alla rovescia di 10 minuti. Per ottenere buoni risultati di cottura, il piatto deve essere messo in forno solo quando il conto alla rovescia è completo. A tale scopo, attendere la fine del segnale di preriscaldamento (2 segnali acustici lunghi), quindi mettere il piatto nel forno e premere nuovamente  per iniziare la cottura.

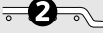
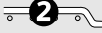
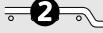
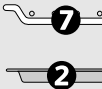

Nota: se la cottura non viene confermata, verrà annullata automaticamente dopo 30 minuti.

Nota: è possibile modificare la temperatura, il tempo o la modalità in qualsiasi momento durante la cottura. Passare quindi alla modalità manuale. Il pulsante menu si spegne ma la cottura continua in base alle impostazioni modificate.

Menu					
Piatto	Pollo*	Arrosto	Pesce	Grill*	
Modalità					
Posizione grill/piatto					
Temperatura (in °C)	220	240	220	240	
Tempo di cottura in minuti / in base al peso (kg)	Preriscaldamento	Nessun preriscaldamento	10	10	Nessun preriscaldamento
	0,2			20	18
	0,3			20	18
	0,4			20	18
	0,5			20	18
	0,6	45	26	21	20
	0,7	50	28	22	22
	0,8	55	30	23	24
	0,9	60	32	24	24
	1	65	34	25	25
	1,1	70	36	26	26
	1,2	75	37	27	27
	1,3	80	38	28	28
	1,4	85	39	29	29
	1,5	90	40	30	30
	1,6	93	42		
	1,7	96	44		
	1,8	99	46		
	1,9	102	48		
	2	105	50		
2,1	108	51			
2,2	111	52			
2,3	114	53			
2,4	117	54			
2,5	120	55			







Per i menu con impostazione delle dimensioni:



- Selezionare il menu desiderato e il pulsante si accende. Le dimensioni lampeggiano sullo schermo ed è necessario immettere le dimensioni della pizza, del gratin, dello sformato o della torta (XL/M/S) premendo i tasti < e >. Il tempo di cottura visualizzato si regola automaticamente in base al peso selezionato. Premere il pulsante  per confermare. A seconda del menu, il forno si avvia in fase di cottura o in fase di preriscaldamento. In caso di preriscaldamento (vedere i relativi menu nella tabella di seguito), sullo schermo viene visualizzato un conto alla rovescia di 10 minuti. Per ottenere buoni risultati di cottura, il piatto deve essere messo in forno solo quando il conto alla rovescia è completo. A tale scopo, attendere la fine del segnale di preriscaldamento (2 segnali acustici lunghi), quindi mettere il piatto nel forno e premere nuovamente  per iniziare la cottura.

Nota: se la cottura non viene confermata, verrà annullata automaticamente dopo 30 minuti.

Nota: è possibile modificare la temperatura, il tempo o la modalità in qualsiasi momento durante la cottura. Passare quindi alla modalità manuale. Il pulsante menu si spegne ma la cottura continua in base alle impostazioni modificate.

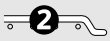
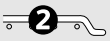
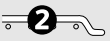
Principale			
Piatto	Pizza	Sformato*	Torta
Modalità			
Posizione grill/piatto 			
Temperatura (in °C)	220	220	170
Tempo di cottura in minuti / in base alle dimensioni	Preriscaldamento	10	Nessun preriscaldamento
	S (da 16 a 22 cm)	18	37
	M (da 22 a 29 cm)	20	38
	XL (da 29 a 33 cm)	38	40
			32

* Avvio ritardato disponibile

Modalità bassa temperatura



Menu scongelamento:



- Premere il pulsante scongelamento per visualizzare l'ora predefinita. È possibile impostare l'ora premendo i tasti e . Iniziare a scongelare il cibo premendo

Avvio ritardato



- Premere il pulsante , quindi i pulsanti e per regolare il tempo dell'avvio ritardato. **Questo è il tempo che precede l'inizio della cottura e non la fine del tempo di cottura.** Una volta impostato il tempo, premere nuovamente per salvarlo.
- È quindi possibile impostare le altre impostazioni (modalità, tempo e temperatura di cottura) ripetendo le istruzioni riportate nel capitolo "Uso manuale".
- Una volta impostate le impostazioni, premere per avviare l'avvio ritardato.
- Al termine del tempo di avvio ritardato, la cottura viene avviata automaticamente.

Nota: Finché la cottura non è iniziata, è possibile modificare il tempo di avvio ritardato. A tale scopo, premere e reimpostare il valore utilizzando i tasti e . Premere nuovamente su o per confermare il nuovo tempo di avvio ritardato. È inoltre possibile annullare e tornare alle impostazioni di cottura selezionate premendo



Mantenimento in caldo

- Se si desidera che il forno passi automaticamente alla modalità di mantenimento in caldo dopo la cottura, premere il tasto durante le fasi di impostazione della cottura. È possibile attivarlo anche durante la cottura premendo il pulsante .
- Il logo viene visualizzato sullo schermo per indicare che la funzione è attivata.

- Per annullare l'operazione, è sufficiente premere nuovamente il pulsante .
- La modalità di mantenimento in caldo si arresta automaticamente dopo 6 ore, ma è possibile arrestarla prima premendo .

Nota: non è possibile impostare la modalità di mantenimento in caldo per l'attivazione dopo lo scongelamento.

La modalità di mantenimento in caldo può essere impostata solo per l'attivazione dopo la cottura, non può essere attivata da sola.

Problema	Possibili cause	Soluzione
L'apparecchio non funziona	L'apparecchio non è collegato correttamente alla presa	Verificare che l'apparecchio sia collegato correttamente alla presa elettrica
	L'apparecchio non si scalda	Portare l'apparecchio presso un centro di assistenza autorizzato
Sullo schermo dell'apparecchio viene visualizzato il codice di errore E01	Il sensore della temperatura è guasto	Portare l'apparecchio presso un centro di assistenza autorizzato
Nessuna illuminazione nella cavità del forno durante la cottura	La lampadina si è bruciata	Sostituire la lampadina (disponibile presso un centro di assistenza autorizzato).
	Il problema persiste	Portare l'apparecchio presso un centro di assistenza autorizzato

PULIZIA

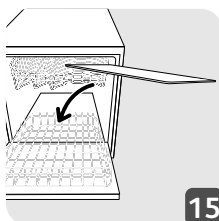
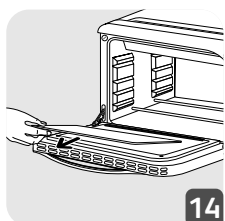
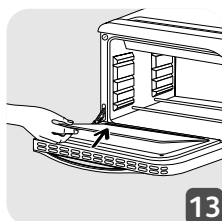
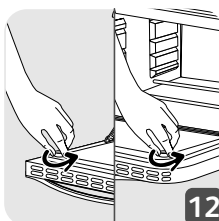
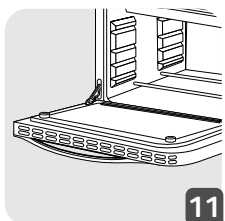
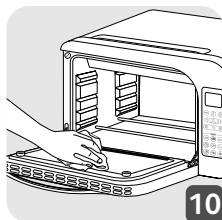
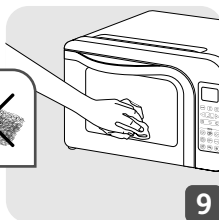
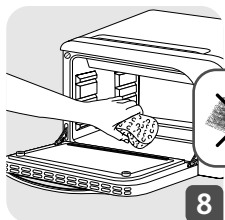
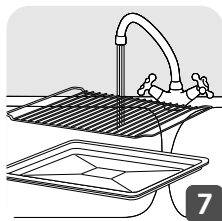
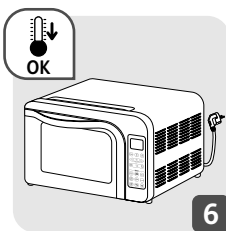
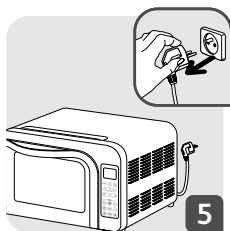

CONSIGLI

IT

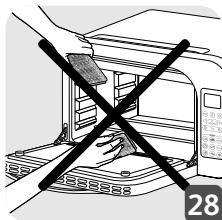
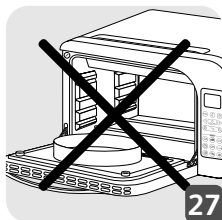
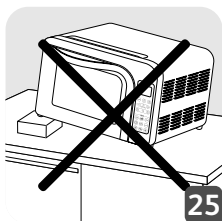
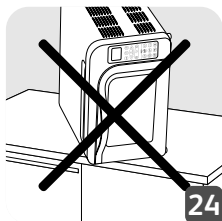
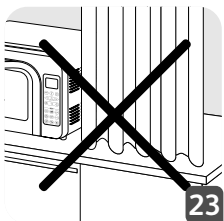
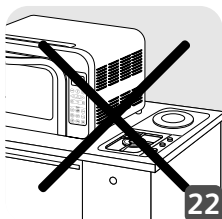
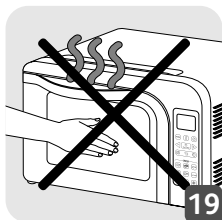
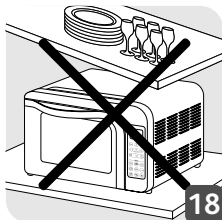

DESCRIPCIÓN

- 1 Resistencias superiores
- 2 Paredes antiadherentes
- 3 Resistencias inferiores
- 4 Puerta de vidrio triple
- 5 Panel de control
 - a Selección de modo
 - b Selección de la temperatura de cocción
 - c Selección del reloj/tiempo de cocción
 - d Botón de selección de ajustes (<)
 - e Botón de inicio/fin de la cocción
 - f Botón de selección de ajustes (>)
 - g Botón Mantener caliente
 - h Botón Cancelar
 - i Botón de programación diferida
- 6 Pantalla LCD
 - a Modo de cocción por convección
 - b Modo de cocción tradicional
 - c Modo de cocción al grill
 - d Modo de horneado
 - e Modo de cocción al baño maría
 - f Tamaño de plato XL
 - g Tamaño de plato M
 - h Tamaño de plato S
 - i Temperatura
 - j Peso
 - k Pantalla de tiempo (hora/tiempo de cocción/tiempo de programación diferida)
 - l Programación diferida
 - m Mantener caliente
- 7 Menús automáticos
 - a Pollo
 - b Asado
 - c Pescado
 - d Pizza
 - e Grill
 - f Modo de temperatura baja
 - g Pastel
 - h Bizcocho
 - i Descongelación
- 8 Luz interior
- 9 Cable de alimentación
- 10 Grill reversible
- 11 Bandeja recogegotas

AJUSTE DEL RELOJ

- Al utilizarlo por primera vez puedes ajustar la hora que aparece en la pantalla.
- Cuando enchufes el horno la pantalla mostrará "00:00". Ajusta primero las horas con los botones ◀ y ▶, y confirma pulsando ⏻. Repite el mismo proceso para los minutos.

Ten en cuenta lo siguiente: La hora no se guarda cuando el horno está desenchufado. Debes repetir este proceso cada vez que enchufes el horno.

DESEMBALAJE Y USO DEL APARATO POR PRIMERA VEZ

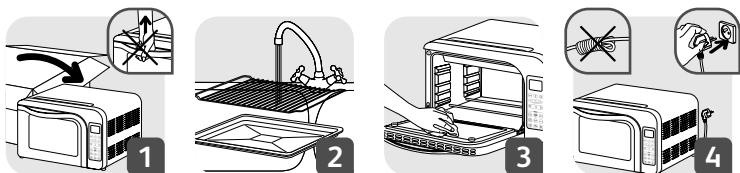

- Sacar el horno de su embalaje, con cuidado de no tirar de él por el asa (1). Retira todas las pegatinas y los materiales protectores, tanto del interior como del exterior del horno. Coloca el horno en una superficie estable. Limpia las superficies esmaltadas o lacadas (2) y la puerta (3) con una esponja húmeda y detergente suave. Sécalo bien.
- Desenrolla el cable y enchúfalo a una toma de corriente con toma de tierra (4).
- Antes de utilizar el horno por primera vez, se recomienda calentarlo a la temperatura máxima durante 10 minutos. Para salir de la pantalla del reloj y acceder a los ajustes antes de cocinar, pulsa el botón **mode**. Pulsa el botón **mode** hasta seleccionar el modo de cocción por convección . Pulsa el botón y, a continuación ◀ y ▶, hasta que se muestre la temperatura máxima de 240 °C. Después, pulsa el botón para mostrar el tiempo predeterminado y utiliza los botones ◀ y ▶ para llegar al tiempo recomendado de 10 minutos. Pulsa para confirmar los ajustes y comenzar a calentar. La cuenta atrás del tiempo de cocción se muestra en la pantalla y la luz interior permanece encendida.
- Transcurridos 10 minutos, el horno emite un sonido y la pantalla muestra "Fin".

USO MANUAL



- Para salir de la pantalla del reloj y acceder a los ajustes antes de cocinar, pulsa el botón .

Ajuste del modo de cocción



- Para seleccionar el modo de cocción, pulsa el botón  hasta llegar al modo de cocción deseado.





Ajuste de la temperatura

- Pulsa el botón  para mostrar la temperatura predeterminada. Ajusta la temperatura deseada pulsando los botones  y .

Ajuste del tiempo de cocción

- Pulsa el botón  para mostrar el tiempo predeterminado. Ajusta el tiempo deseado pulsando los botones  y .

Validación

- Para comenzar la cocción, pulsa el botón . Durante la cocción el botón  se ilumina, la cuenta atrás del tiempo de cocción se muestra en la pantalla y la luz interior permanece encendida.

Fin de la cocción

- Al final de la cocción, si la función Mantener caliente no está activada, el horno emite un sonido y la pantalla muestra "Fin".
- Si se ha activado la función Mantener caliente (consulta el capítulo "Mantener caliente"), la pantalla muestra el tiempo que se conservará el calor. El tiempo se incrementa por intervalos hasta un máximo de 6 horas.
- **Ten en cuenta lo siguiente: Puedes cambiar la temperatura, el tiempo, el modo o activar el ajuste Mantener caliente en cualquier momento durante la cocción pulsando directamente los botones correspondientes.**



Low Tempe Mode

Establecer el modo de baja temperatura



ES

- Pulsa el botón de 
- Está encendida la luz del botón de 

Ajuste del tiempo de cocción

- Tiempo de cocción estándar de dos horas
- Pulsa los botones  y  para ajustar el tiempo de cocción deseado. (Se puede elegir entre 30 minutos y 4 horas).



Pre calentamiento

- Pulsa el botón de  para iniciar el pre calentamiento.
- Suena un pitido largo y permanece encendida la luz del botón de 
- Está encendido el botón de 



Durante el pre calentamiento, parpadea el botón de 

- El tiempo predeterminado del pre calentamiento es de 15 minutos. Cuando termine, volverán a sonar 2 pitidos largos.
- Puedes introducir alimentos en el horno.

Iniciar la cocción

- Para iniciar la cocción, pulsa el botón de .
- Durante la cocción, se encienden las luces de los botones de  y .
- El contador del tiempo de cocción se muestra en pantalla y las luces internas permanecen encendidas.

Establecer otro tiempo

- Por favor ten cuenta lo siguiente: Si quieres establecer otro tiempo durante la cocción, pulsa el botón de   y .

Fin de la cocción

- Cuando termine la cocción, si la función de conservar el calor no está activada, el horno emitirá 3 pitidos largos y en la pantalla aparecerá la palabra «FIN».

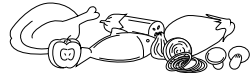

	230g + 300g			15 min	Low Temp.	*35
	250g x2			15 min	Low Temp.	*59
	300g x2			15 min	Low Temp.	*63

Advertencia de seguridad alimentaria

⚠ PRECAUCIÓN: Los alimentos no se pasteurizan a baja temperatura y pueden suponer un riesgo para determinadas personas. Entre estas personas se incluyen mujeres embarazadas, niños pequeños, ancianos u otras personas con problemas inmunológicos.

Alimentos crudos:

Adquiere tus alimentos crudos de fuentes o distribuidores conocidos y aprobados. Si notas algún tipo de deterioro, contaminación por suciedad, decoloración o mal olor o sabor, no utilices esos ingredientes. Recuerda enjuagar con abundante agua las frutas y verduras antes de utilizarlas. Respeta las condiciones de uso y conservación antes de utilizar estos alimentos crudos.

Limpieza:

Para evitar la contaminación por parte de equipos y utensilios, límpialos antes de usarlos y ponerlos en contacto con los alimentos. Límpialos con lavavajillas líquido y una esponja limpia. A continuación, enjuágalos bien y déjalos secar al aire. También es necesario limpiar y desinfectar la encimera antes de utilizarla. Además, una higiene habitual y cuidadosa de las manos reduce el riesgo de contaminación. Recuerda lavarte las manos antes de comenzar a preparar los alimentos, así como durante la preparación, si vas a manipular alimentos crudos o sucios (plantas con tierra). Si tienes heridas o cortes en las manos, asegúrate de desinfectarlas y colocar un apósito adecuado antes de preparar los alimentos. Disfruta de comidas preparadas rápidamente cuando estén listas.

USO DE MENÚ AUTOMÁTICOS



ES

El horno tiene menús preprogramados: determina automáticamente el modo, el tiempo y la temperatura en función del peso o tamaño del plato que introduzcas.

Para salir de la pantalla del reloj y acceder a los ajustes antes de cocinar, pulsa el botón de menú que desees.













Para menús con ajuste de peso:



- Selecciona el menú que desees y se encenderá el botón correspondiente. En la pantalla empezará a parpadear el peso y deberás introducir el peso de la carne, el ave o el pescado pulsando las teclas < y >. El tiempo de cocción mostrado se ajusta automáticamente según el peso seleccionado. Pulsa el botón  para confirmar. En función del menú, el horno comienza en la fase de cocción o en la fase de precalentamiento. En caso de que haya precalentamiento (consulta los menús correspondientes en la tabla de la página siguiente), se muestra una cuenta atrás de 10 minutos en la pantalla. Para obtener unos resultados de cocción correctos, el plato solo debe introducirse en el horno cuando finalice la cuenta atrás. Para ello, espera a que finalice la señal de precalentamiento (2 pitidos largos), coloca el plato en el horno y vuelve a pulsar  para iniciar la cocción.

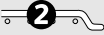
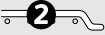

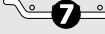
Nota: Si no confirmas la cocción se cancelará automáticamente transcurridos 30 minutos.

Ten en cuenta lo siguiente: Puedes cambiar la temperatura, el tiempo o el modo en cualquier momento durante la cocción. En ese caso, cambias al modo manual. El botón del menú se apaga, pero la cocción continúa según los ajustes que hayas modificado.

Menú					
Plato		Pollo*	Asado	Pescado	Grill*
Modo					
Posición de plato/grill 					 
Temperatura (en °C)		220	240	220	240
Tiempo de cocción en minutos/ según el peso (kg)	Pre calentamiento	Sin pre calentamiento	10	10	Sin pre calentamiento
	0,2			20	18
	0,3			20	18
	0,4			20	18
	0,5			20	18
	0,6	45	26	21	20
	0,7	50	28	22	22
	0,8	55	30	23	24
	0,9	60	32	24	24
	1	65	34	25	25
	1,1	70	36	26	26
	1,2	75	37	27	27
	1,3	80	38	28	28
	1,4	85	39	29	29
	1,5	90	40	30	30
	1,6	93	42		
	1,7	96	44		
	1,8	99	46		
1,9	102	48			
2	105	50			
2,1	108	51			
2,2	111	52			
2,3	114	53			
2,4	117	54			
2,5	120	55			

Para menús con ajuste de tamaño:









- Selecciona el menú deseado y el botón se iluminará. En la pantalla empezará a parpadear el plato y deberás introducir el tamaño de la pizza, el gratinado, el pastel o el bizcocho (XL/M/S) pulsando las teclas \leftarrow y \rightarrow. El tiempo de cocción mostrado se ajusta automáticamente según el peso seleccionado. Pulsa el botón  para confirmar. En función del menú, el horno comienza en la fase de cocción o en la fase de precalentamiento. En caso de que haya precalentamiento (consulta los menús correspondientes en la tabla que aparece a continuación), se muestra una cuenta atrás de 10 minutos en la pantalla. Para obtener unos resultados de cocción correctos, el plato solo debe introducirse en el horno cuando finalice la cuenta atrás. Para ello, espera a que finalice la señal de precalentamiento (2 pitidos largos), coloca el plato en el horno y vuelve a pulsar  para iniciar la cocción.

ES

Nota: Si no confirmas la cocción se cancelará automáticamente transcurridos 30 minutos.

Ten en cuenta lo siguiente: Puedes cambiar la temperatura, el tiempo o el modo en cualquier momento durante la cocción. En ese caso, cambias al modo manual. El botón del menú se apaga, pero la cocción continúa según los ajustes que hayas modificado.

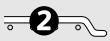
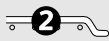
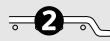
Principal				
Plato		Pizza	Pastel*	Bizcocho
Modo				
Posición de plato/grill 				
Temperatura (en °C)		220	220	170
Tiempo de cocción en minutos/según el tamaño	Precalentamiento	10	Sin precalentamiento	10
	S (de 16 a 22 cm)	18	37	20
	M (de 22 a 29 cm)	20	38	20
	(de 29 a 33 cm)	38	40	32

* Programación diferida disponible

Modo de temperatura baja



Menú Descongelación:







- Pulsa el botón de descongelación para mostrar el tiempo predeterminado. Puedes ajustar el tiempo pulsando las teclas y . Comienza a descongelar los alimentos pulsando

Programación diferida

- Pulsa el botón y, a continuación, los botones y para ajustar el tiempo de programación diferida. **Este es el tiempo que falta para que comience la cocción y no el final del tiempo de cocción.** Una vez ajustado el tiempo, pulsa de nuevo para guardarlo.
- A continuación, es posible realizar los demás ajustes (modo, tiempo y temperatura de cocción) repitiendo las instrucciones del capítulo "Uso manual".
- Una vez configurados los ajustes, pulsa para iniciar la programación diferida.
- Al final del tiempo de programación diferida, la cocción se inicia automáticamente.

Ten en cuenta lo siguiente: Siempre que la cocción no haya comenzado puedes cambiar el tiempo de programación diferida. Para ello, pulsa y restablece el valor usando las teclas y . Vuelve a pulsar o para confirmar el nuevo tiempo de programación diferida. También es posible cancelar y volver a los ajustes de cocción seleccionados pulsando .

Mantener caliente

- Si deseas que el horno pase al modo Mantener caliente automáticamente después de cocinar, pulsa la tecla  durante los pasos de ajuste de la cocción. También se puede activar durante la cocción pulsando el botón .
- Aparece el logotipo  en la pantalla, lo que indica que la función está activada.
- Para cancelarlo solo tienes que pulsar el botón  otra vez.
- El modo Mantener caliente se detendrá automáticamente después de 6 horas, pero puede detenerse antes pulsando .

Nota: El modo Mantener caliente no se puede ajustar después de descongelar.

El modo Mantener caliente solo se puede ajustar después de la cocción, no se puede activar solo.

Problema	Causas posibles	Solución
El aparato no funciona	El enchufe no está bien conectado	Comprueba que el aparato está enchufado correctamente
	El aparato no calienta	Lleva el aparato a un servicio técnico oficial
El aparato muestra un código de error E01 en la pantalla	El sensor de temperatura está defectuoso	Lleva el aparato a un servicio técnico oficial
El interior del horno no se ilumina durante la cocción	La bombilla se ha fundido	Cambia la bombilla (disponible en un servicio técnico oficial).
	El problema persiste	Lleva el aparato a un servicio técnico oficial

LIMPIEZA

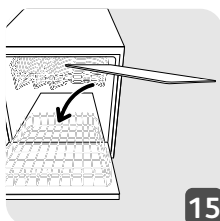
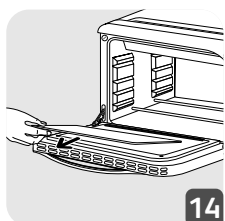
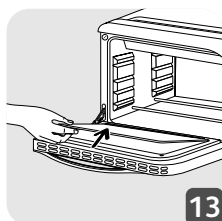
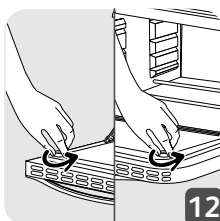
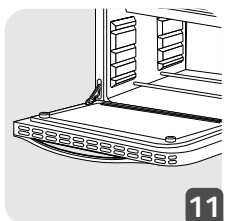
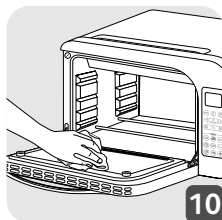
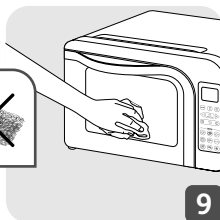
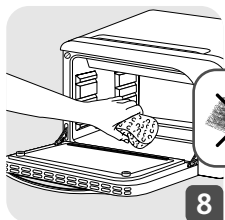
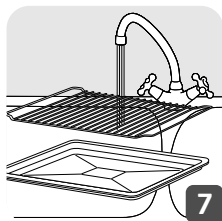
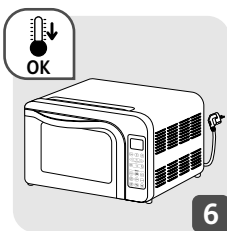
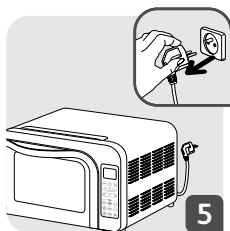

RECOMENDACIONES

ES

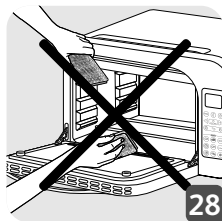
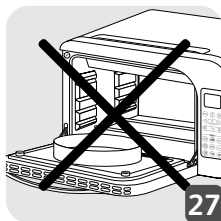
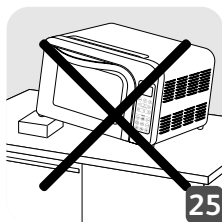
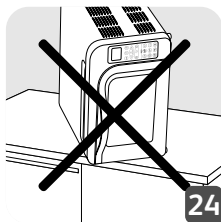
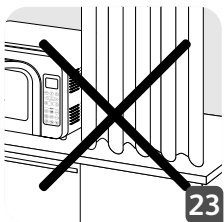
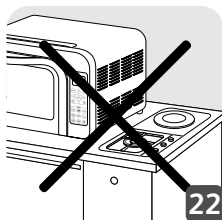
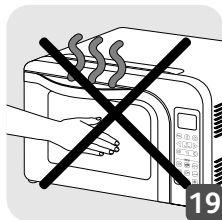
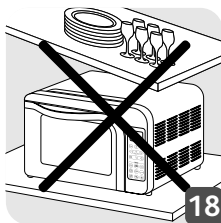

DESCRIÇÃO

- 1 Elementos de aquecimento superiores
- 2 Paredes antiaderentes
- 3 Elementos de aquecimento inferiores
- 4 Porta de vidro com parede tripla
- 5 Painel de controlo
 - a Seleção do modo
 - b Seleção da temperatura de cozedura
 - c Seleção do tempo de cozedura/relógio
 - d Botão de seleção de definições (<)
 - e Botão para iniciar/parar a cozedura
 - f Botão de seleção de definições (>)
 - g Botão Manter quente
 - h Botão de cancelamento
 - i Botão de início diferido
- 6 Ecrã LCD
 - a Modo de cozedura por convecção
 - b Modo de cozedura tradicional
 - c Modo Grill
 - d Modo de cozedura de pastelaria
 - e Modo de cozedura em banho-maria
 - f Tamanho do prato XL
 - g Tamanho do prato M
 - h Tamanho do prato S
 - i Temperatura
 - j Peso
 - k Apresentação da hora (hora/tempo de cozedura/hora de início diferido)
 - l Início diferido
 - m Manter quente
- 7 Menus automáticos
 - a Frango
 - b Assado
 - c Peixe
 - d Pizza
 - e Grill
 - f Modo de baixa temperatura
 - g Tarte
 - h Bolo
 - i Descongelação
- 8 Luz interior
- 9 Cabo de alimentação
- 10 Grelha reversível
- 11 Gaveta de recolha de pingos

ACERTAR O RELÓGIO





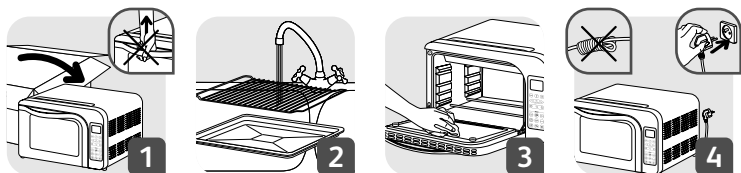

PT

- Quando o utilizar pela primeira vez, pode acertar a hora apresentada no ecrã.
- Quando ligar o forno à corrente, o ecrã apresenta "00:00". Acerte primeiro as horas utilizando os botões < e > e confirme premindo . Repita o mesmo processo para os minutos.

Atenção: A hora não é guardada quando o forno é desligado da corrente. Tem de repetir este processo sempre que ligar o forno.

DESEMBALAR E UTILIZAR PELA PRIMEIRA VEZ



- Retire o forno da embalagem, tendo cuidado para não o puxar pela pega (1). Retire todos os autocolantes e materiais de proteção dentro e fora do forno. Coloque o forno numa superfície estável. Limpe as superfícies esmaltadas ou lacadas (2) e a porta (3) com uma esponja húmida e detergente líquido para a loiça. Seque bem.
- Desenrole o cabo e ligue-o a uma tomada elétrica com ligação à terra (4).
- Antes de utilizar pela primeira vez, recomenda-se que aqueça o forno à temperatura máxima durante 10 minutos. Para sair do visor do relógio e aceder às definições antes de cozinhar, prima o botão . Prima o botão  até que o modo de cozedura por convecção  esteja selecionado. Prima o botão  e, em seguida, < e > até ser apresentada a temperatura máxima de 240 °C. Em seguida, prima o botão  para apresentar a hora predefinida e utilize os botões < e > para atingir o tempo recomendado de 10 minutos. Prima  para confirmar as suas definições e iniciar o aquecimento. A contagem decrescente do tempo de cozedura é apresentada no ecrã e a luz interior permanece acesa.
- Após 10 minutos, o forno emite um sinal sonoro e o ecrã apresenta "End" (Fim).

UTILIZAÇÃO MANUAL



- Para sair do visor do relógio e aceder às definições antes de cozinhar, prima os botões .

Definição do modo de cozedura



- Para escolher o modo de cozedura, prima o botão  até chegar ao modo de cozedura pretendido.





Regulação da temperatura

- Prima o botão  para apresentar a temperatura predefinida. Ajuste a temperatura pretendida premindo os botões  e .

Definição do tempo de cozedura.

- Prima o botão  para apresentar o tempo predefinido. Ajuste o tempo pretendido premindo os botões  e .

Validação

- Para iniciar a cozedura, prima o botão . Durante a cozedura, o botão  acende-se, a contagem decrescente do tempo de cozedura é apresentada no ecrã e a luz interior permanece acesa.

Fim da cozedura



- No final da cozedura, se a função "manter quente" não estiver ativada, o forno emite um sinal sonoro e o ecrã apresenta "End" (Fim).
- Se a função "manter quente" tiver sido ativada (consulte o capítulo "Manter quente"), o ecrã apresenta o tempo para manter quente. O tempo é apresentado em incrementos de até um máximo de 6 horas.
- **Atenção: Pode alterar a temperatura, o tempo e o modo ou ativar a definição "manter quente" a qualquer momento durante a cozedura, premindo diretamente os botões correspondentes.**

Low Tempe Mode





Definição do modo de baixa temperatura

- Prima o botão 
- A luz do botão  está ligada



Definição do tempo de cozedura.

- Tempo de cozedura predefinido de 2 horas
- Prima os botões  e  para ajustar o tempo de preparação pretendido. (Pode escolher entre 30 minutos e 4 horas).



Pré-aquecimento

- Prima o botão  para iniciar o pré-aquecimento.
- A luz do botão  permanece ligada e é acompanhada por um aviso sonoro prolongado.
- O botão  está ligado
 intermitente significa pré-aquecimento
- O tempo de pré-aquecimento predefinido é de 15 minutos; quando o pré-aquecimento estiver concluído, são emitidos dois avisos sonoros prolongados.
- Pode colocar alimentos no forno.

Começar a cozinhar

- Para começar a cozinhar, prima o botão .
- Durante a cozedura, as luzes dos botões  e  estão ligadas.
- A contagem decrescente do tempo de cozedura é apresentada no ecrã e a luz interior permanece ligada.

Definir novo tempo de cozedura

- Atenção: Durante a cozedura, se pretender definir um novo intervalo, prima os botões   e  para definir um novo tempo de cozedura;

Fim da cozedura

- No final da cozedura, se a função «manter quente» não estiver ativada, o forno emite três avisos sonoros prolongados e o ecrã apresenta a mensagem «END» (FIM).



	230g + 300g	Low Temp		15 min	Low Temp.	*35
	250g x2	Low Temp		15 min	Low Temp.	*59
	300g x2	Low Temp		15 min	Low Temp.	*63

Aviso de segurança alimentar

⚠ CUIDADO: os alimentos não são pasteurizados a baixas temperaturas e podem representar um risco para determinadas pessoas. Estas pessoas incluem mulheres grávidas, crianças, idosos ou pessoas com um sistema imunitário comprometido.

Produtos:

Adquira os seus produtos a partir de fontes ou distribuidores conhecidos e aprovados. Se reparar em qualquer sinal de deterioração, contaminação por sujidade, descoloração ou mau cheiro e/ou sabor, não utilize estes ingredientes. Não se esqueça de enxaguar a fruta e os legumes com muita água antes de utilizar. Respeite as condições de utilização e conservação antes de utilizar estes produtos.

Higiene:

Para evitar a contaminação através de equipamentos e utensílios, limpe-os antes de os utilizar e colocar em contacto com os alimentos. Limpe com uma esponja limpa e detergente líquido para a loiça. Em seguida, enxague-os bem e deixe secar ao ar. Também é necessário limpar e desinfetar a superfície de trabalho antes de a utilizar. Além disso, uma higiene regular e cuidadosa das mãos reduz o risco de contaminação. Lembre-se de lavar as mãos antes de preparar os alimentos, bem como durante a preparação de alimentos crus ou com sujidade (plantas com terra). Se tiver feridas ou cortes nas mãos, certifique-se de que desinfeta e coloca um penso adequado antes de cada preparação. Coma refeições preparadas de imediato assim que estiverem prontas.

UTILIZAÇÃO DE MENUS AUTOMÁTICOS



PT

O seu forno tem menus pré-programados: determina automaticamente o modo, o tempo e a temperatura de acordo com o peso ou o tamanho do prato que inserir.

Para sair do visor do relógio e aceder às definições antes de cozinhar, prima o botão do menu pretendido.











Para menus com definição de peso:



- Selecione o menu pretendido e o botão correspondente acende-se. O peso fica intermitente no ecrã e tem de introduzir o peso da carne, da ave ou do peixe premindo as teclas < e >. O tempo de cozedura apresentado ajusta-se automaticamente de acordo com o peso selecionado. Prima o botão  para confirmar. Consoante o menu, o forno inicia na fase de cozedura ou na fase de pré-aquecimento. No caso de pré-aquecimento (consulte os menus relevantes na tabela da página seguinte), é apresentada uma contagem decrescente de 10 minutos no ecrã. Para obter bons resultados de cozedura, o prato só deve ser colocado no forno quando esta contagem decrescente estiver concluída. Para tal, aguarde pelo fim do sinal de pré-aquecimento (2 avisos sonoros longos) e, em seguida, coloque o prato no forno e prima  novamente para começar a cozinhar.

Nota: se não confirmar a cozedura, esta será automaticamente cancelada após 30 minutos.

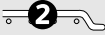
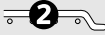
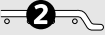

Atenção: Pode alterar a temperatura, o tempo ou o modo a qualquer momento durante a cozedura. Em seguida, é alterada para o modo manual. O botão do menu desliga-se, mas a cozedura continua de acordo com as definições que alterou.

Menu					
Prato	Frango*	Assado	Peixe	Grill*	
Modo					
Posição da grelha/prato 				 	
Temperatura (em °C)	220	240	220	240	
Tempo de cozedura em minutos/de acordo com o peso (kg)	Pré-aquecimento	Sem pré-aquecimento	10	10	Sem pré-aquecimento
	0,2			20	18
	0,3			20	18
	0,4			20	18
	0,5			20	18
	0,6	45	26	21	20
	0,7	50	28	22	22
	0,8	55	30	23	24
	0,9	60	32	24	24
	1	65	34	25	25
	1,1	70	36	26	26
	1,2	75	37	27	27
	1,3	80	38	28	28
	1,4	85	39	29	29
	1,5	90	40	30	30
	1,6	93	42		
	1,7	96	44		
	1,8	99	46		
	1,9	102	48		
	2	105	50		
2,1	108	51			
2,2	111	52			
2,3	114	53			
2,4	117	54			
2,5	120	55			

Para menus com definição de tamanho:









PT

- Seleção o menu pretendido e o botão acende-se. O tamanho fica intermitente no ecrã e tem de introduzir o tamanho da sua pizza, gratinado, tarte ou bolo (XL/M/S) premindo as teclas ◀ e ▶. O tempo de cozedura apresentado ajusta-se automaticamente de acordo com o peso selecionado. Prima o botão  para confirmar. Consoante o menu, o forno inicia na fase de cozedura ou na fase de pré-aquecimento. No caso de pré-aquecimento (consulte os menus relevantes na tabela abaixo), é apresentada uma contagem decrescente de 10 minutos no ecrã. Para obter bons resultados de cozedura, o prato só deve ser colocado no forno quando esta contagem decrescente estiver concluída. Para tal, aguarde pelo fim do sinal de pré-aquecimento (2 avisos sonoros longos) e, em seguida, coloque o prato no forno e prima  novamente para começar a cozinhar.

Nota: se não confirmar a cozedura, esta será automaticamente cancelada após 30 minutos.

Atenção: Pode alterar a temperatura, o tempo ou o modo a qualquer momento durante a cozedura. Em seguida, é alterada para o modo manual. O botão do menu desliga-se, mas a cozedura continua de acordo com as definições que alterou.

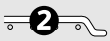
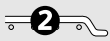
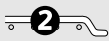
Principal				
Prato	Pizza	Tarte*	Bolo	
Modo				
Posição da grelha/prato 				
Temperatura (em °C)	220	220	170	
Tempo de cozedura em minutos/de acordo com o tamanho	Pré-aquecimento	10	Sem pré-aquecimento	10
	S (de 16 a 22 cm)	18	37	20
	M (de 22 a 29 cm)	20	38	20
	XL (de 29 a 33 cm)	38	40	32

* Início diferido disponível

Modo de baixa temperatura



Menu de descongelação:







- Prima o botão de descongelação para apresentar o tempo predefinido. Pode definir o tempo premindo as teclas e . Comece a descongelar os seus alimentos premindo

Início diferido

- Prima o botão e, em seguida, os botões e para ajustar a hora do início diferido. **Este é o tempo antes do início da cozedura e não o final do tempo de cozedura.** Depois de definir este tempo, prima novamente para guardar.
- Em seguida, é possível escolher as outras definições (modo, tempo e temperatura de cozedura) repetindo as instruções no capítulo "Utilização manual".
- Depois de escolher as definições, prima para começar o início diferido.
- No final do tempo de início diferido, a cozedura é iniciada automaticamente.

Atenção: desde que a cozedura não tenha sido iniciada, pode alterar a hora de início diferido. Para isso, prima e reponha o valor utilizando as teclas e . Prima novamente ou para confirmar esta nova hora de início diferido. Também é possível cancelar e regressar às definições de cozedura selecionadas, premindo .

Manter quente

- Se pretender que o seu forno entre automaticamente no modo "Manter quente" depois de cozinhar, prima a tecla  durante os passos de regulação de cozedura. Também pode ser ativado durante a cozedura premindo o botão .
- O logotipo  é apresentado no ecrã, indicando que a função está ativada.
- Para cancelar, basta premir novamente o botão .
- O modo "Manter quente" para automaticamente após 6 horas, mas é possível parar antes ao premir .

Nota: o modo "Manter quente" não pode ser definido para depois da descongelação.

O modo "Manter quente" só pode ser definido para depois de cozinhar; não pode ser ativado sozinho.

Problema	Causas possíveis	Solução
O aparelho não funciona	O aparelho não está ligado corretamente à corrente	Verifique se o aparelho está ligado corretamente à corrente
	O aparelho não aquece	Leve o aparelho a um Serviço de Assistência Técnica autorizado
O aparelho apresenta um código de erro E01 no ecrã	O sensor de temperatura está avariado	Leve o aparelho a um Serviço de Assistência Técnica autorizado
Não há iluminação na cavidade do forno durante a cozedura	A lâmpada fundiu-se	Substitua a lâmpada (disponível num Serviço de Assistência Técnica Autorizado).
	O problema persiste	Leve o aparelho a um Serviço de Assistência Técnica autorizado

LIMPEZA

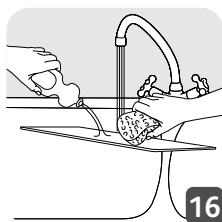
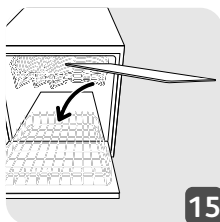
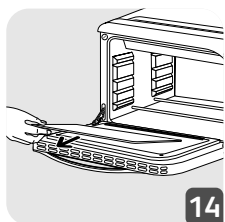
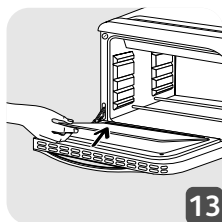
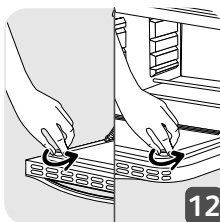
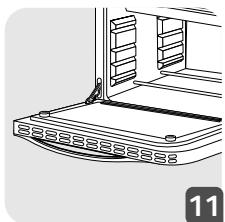
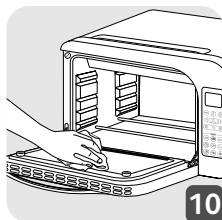
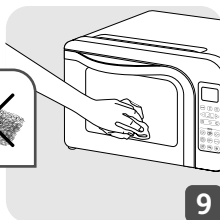
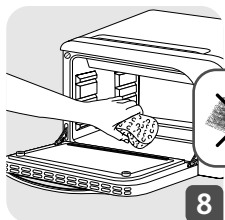
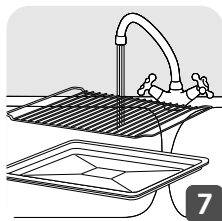
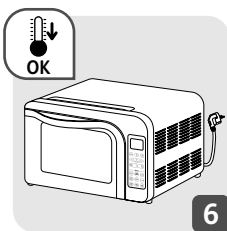
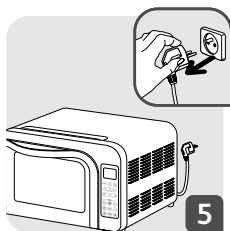

RECOMENDAÇÕES

PT

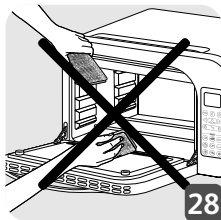
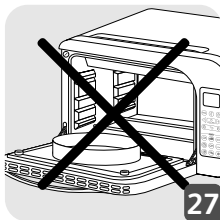
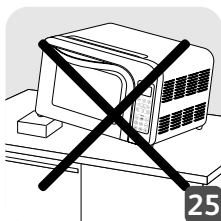
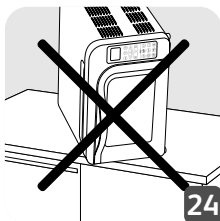
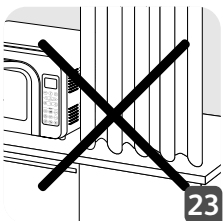
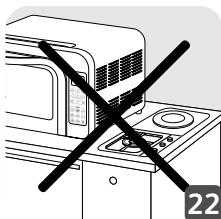
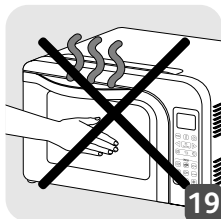

FR p. 4 – 15

EN p. 16 – 27

NL p. 28 – 39

IT p. 40 – 51

ES p. 52 – 63

PT p. 64 – 75