

Moulinex®

Optimo 39L

FR

NL

DE

EN

ES

IT

PT



www.moulinex.com

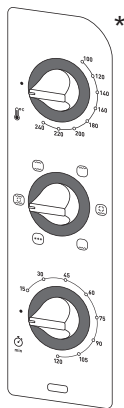
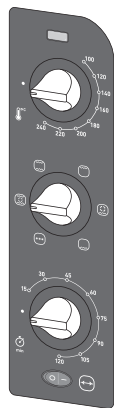
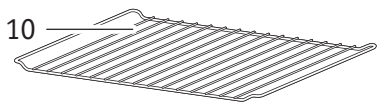
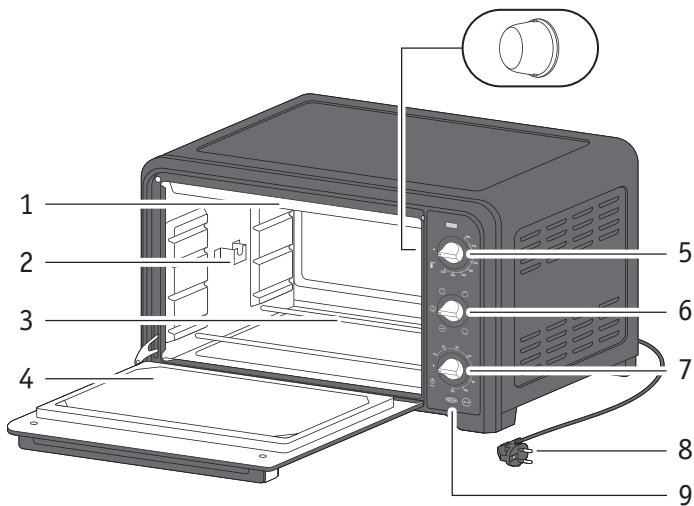

* selon modèle - afhankelijk van het model - je nach Modell - depending on the model - según el modelo - in base al modelo - consoante o modelo

DESCRIPTION

- 1 Résistance supérieure
- 2 Parois aluminium
- 3 Résistance inférieure
- 4 Porte double parois
- 5 Bouton de réglage température
- 6 Bouton des fonctions
- 7 Bouton de minuterie
- 8 Cordon d'alimentation
- 9 Voyant de fonctionnement
- 10 Grille réversible
- 11 Plat lèche-frite*
- 12 Accessoire tourne-broche*
- 13 Poignée support tourne-broche*

BESCHRIJVING

- 1 Bovenste verwarmingselement
- 2 Aluminium wanden
- 3 Onderste verwarmingselement
- 4 Dubbelwandige deur
- 5 Regelbare thermostaatknop
- 6 Functieknop
- 7 Timerknop
- 8 Snoer
- 9 Aan/uit-controlelampje
- 10 Omkeerbaar grillrooster
- 11 Ovenschaal*
- 12 Draaispit*
- 13 Handgreep voor rooster en ovenschaal*

BESCHREIBUNG

- 1 Oberes Heizelement
- 2 Aluminiumwände
- 3 Unteres Heizelement
- 4 Doppelwandige Tür
- 5 Temperaturregler
- 6 Funktionsknopf
- 7 Timer-Knopf
- 8 Netzkabel
- 9 Betriebskontrollleuchte
- 10 Umkehrbarer Grillrost
- 11 Backblech*
- 12 Grillspieß*
- 13 Grillrost und Backblechhalter*

DESCRIPTION

- 1 Top heating element
- 2 Aluminium walls
- 3 Bottom heating element
- 4 Double-wall door
- 5 Temperature control button
- 6 Functions button
- 7 Timer button
- 8 Power cord
- 9 Power indicator light
- 10 Reversible grill rack
- 11 Food tray*
- 12 Rotisserie*
- 13 Grill Rack & Food Tray Handle*

* selon modèle - afhankelijk van het model - je nach Modell - depending on the model - según el modelo - in base al modelo -
consoante o modelo

DESCRIPCIÓN

- 1 Resistencia superior
- 2 Paredes aluminio
- 3 Resistencia inferior
- 4 Puerta de doble cristal
- 5 Botón de ajuste de temperatura
- 6 Botón de funciones
- 7 Botón de temporizador
- 8 Cable de alimentación
- 9 Indicador de funcionamiento
- 10 Parrilla de grill reversible
- 11 Bandeja de comida*
- 12 Asador*
- 13 Asa de la parrilla y la bandeja de alimento*

DESCRIZIONE

- 1 Elemento riscaldante superiore
- 2 Pareti in alluminio
- 3 Elemento riscaldante inferiore
- 4 Porta a doppia parete
- 5 Pulsante di regolazione della temperatura
- 6 Pulsante funzioni
- 7 Pulsante timer
- 8 Cavo di alimentazione
- 9 Spia di alimentazione
- 10 Griglia di cottura reversibile
- 11 Vassoio degli alimenti*
- 12 Girarrosto*
- 13 Manico per griglia & teglia*

DESCRIÇÃO

- 1 Resistência superior
- 2 Paredes alumínio
- 3 Resistência inferior
- 4 Porta de parede dupla
- 5 Botão deregulação da temperatura
- 6 Botão das funções
- 7 Botão temporizador
- 8 Cabo de alimentação
- 9 Luz piloto de funcionamento
- 10 Grelha reversível
- 11 Tableiro*
- 12 Espeto*
- 13 Grelha e pega da bandeja da comida*

* selon modèle - afhankelijk van het model - je nach Modell - depending on the model - según el modelo - in base al modello - consoante o modelo

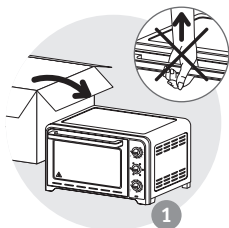
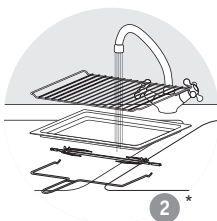
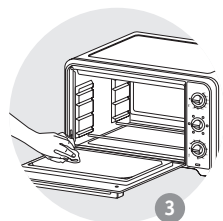
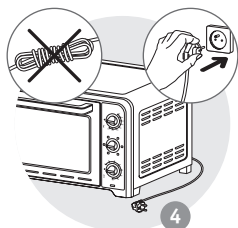
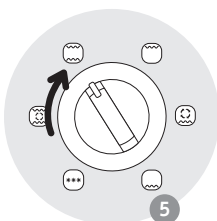
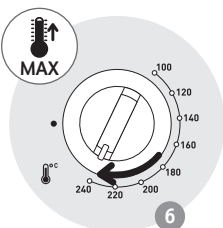
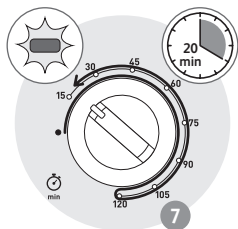
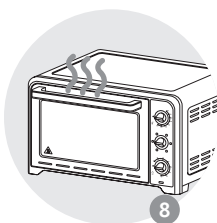
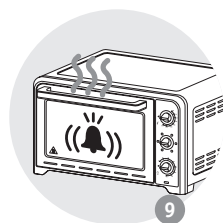
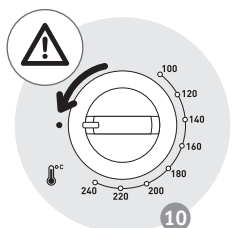
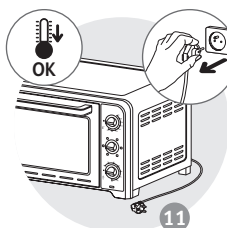
1**1****2*****3****4****5****6****7****8****9****10****11**

* selon modèle - afhankelijk van het model - je nach Modell - depending on the model - según el modelo - in base al modelo - consoante o modelo

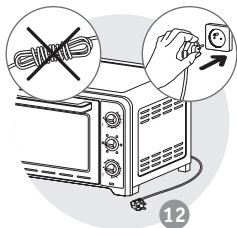

12

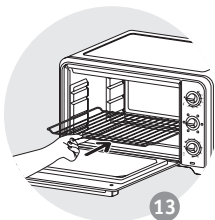

13

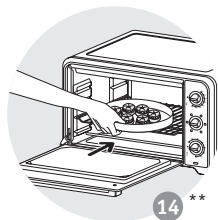

14 **

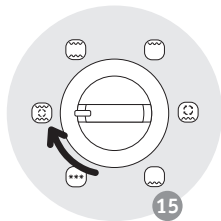

15

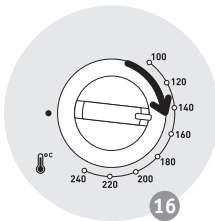

16

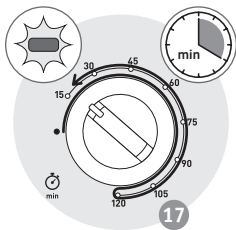

17

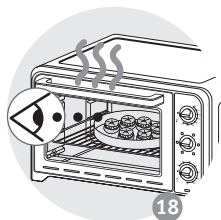

18

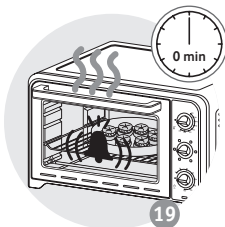

19

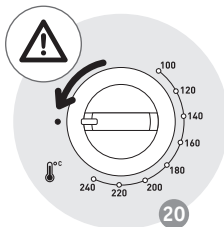

20

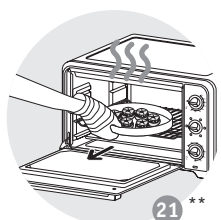

21 **

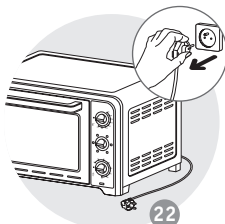

22

** Plat non fourni avec l'appareil
 Schaal niet bij het apparaat inbegrepen
 Platte nicht im Lieferumfang inbegriffen
 The dish is not supplied with the appliance
 El plato no es suministrado con el aparato
 Piatto non fornito con l'apparechio
 Traversa não fornecida com o aparelho

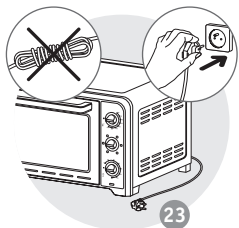

23

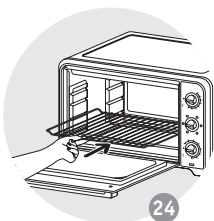

24

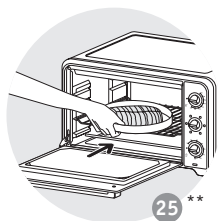

25 **

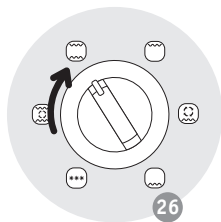

26

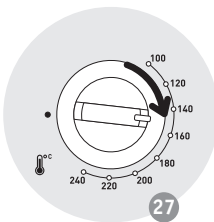

27

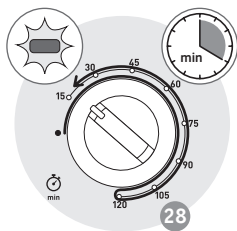

28

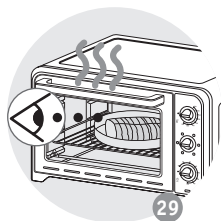

29

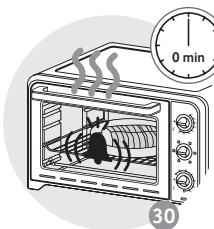

30

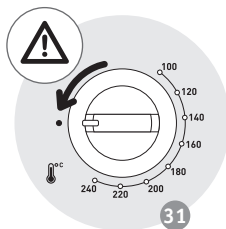

31

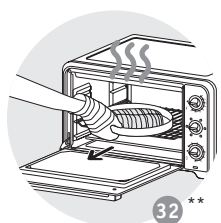

32 **

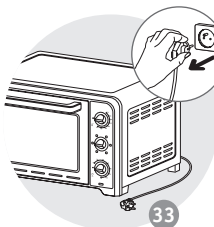

33

** Plat non fourni avec l'appareil
 Schaal niet bij het apparaat inbegrepen
 Platte nicht im Lieferumfang inbegriffen
 The dish is not supplied with the appliance
 El plato no es suministrado con el aparato
 Piatto non fornito con l'apparecchio
 Travessa não fornecida com o aparelho

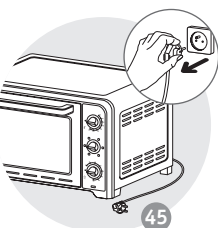
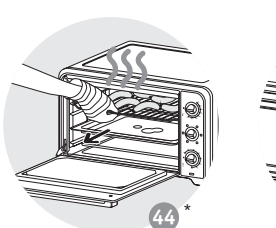
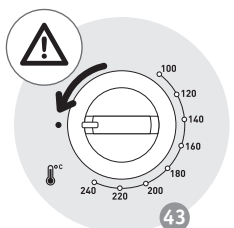
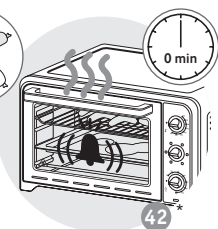
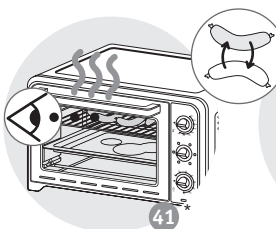
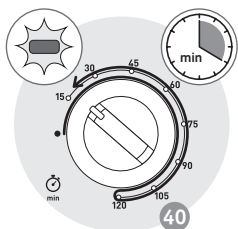
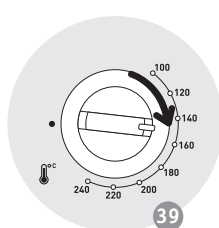
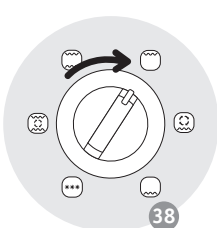
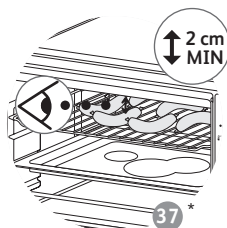
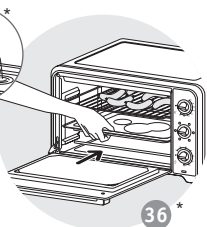
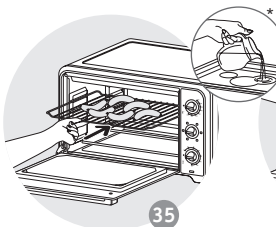
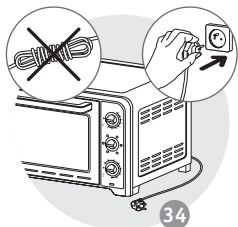

* selon modèle - afhankelijk van het model - je nach Modell - depending on the model - según el modelo - in base al modelo - consoante o modelo

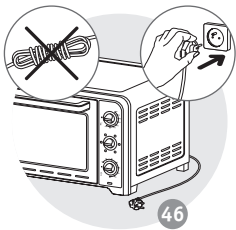

46

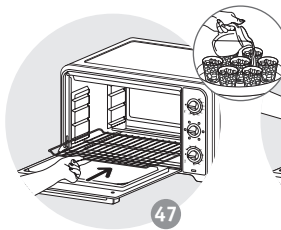

47

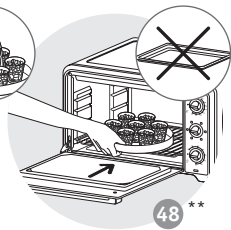

48 **

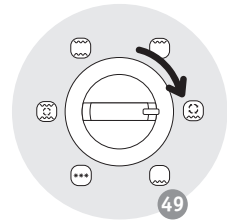

49

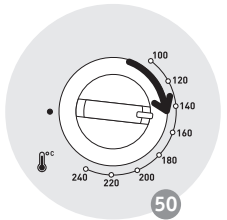

50

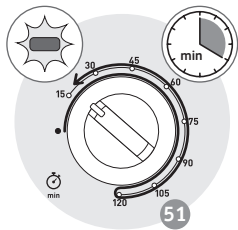

51

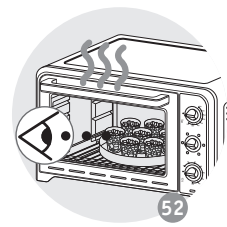

52

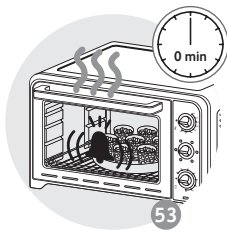

53

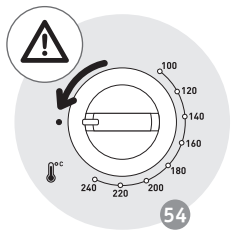

54

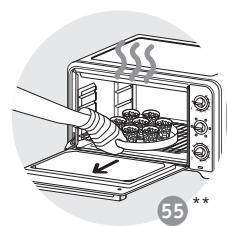

55 **

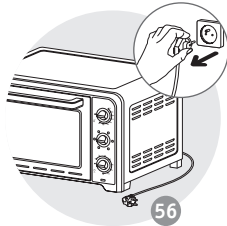

56

** Plat non fourni avec l'appareil
 Schaal niet bij het apparaat inbegrepen
 Platte nicht im Lieferumfang inbegriffen
 The dish is not supplied with the appliance
 El plato no es suministrado con el aparato
 Piatto non fornito con l'apparechio
 Travessa não fornecida com o aparelho

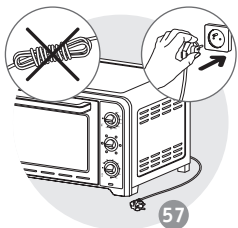

57

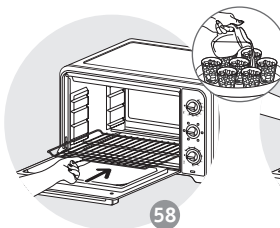

58

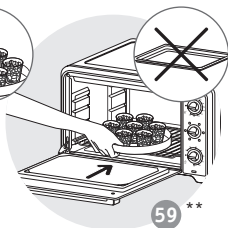

59 **

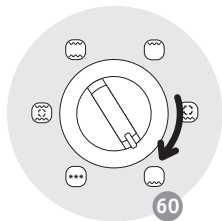

60

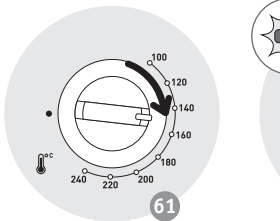

61

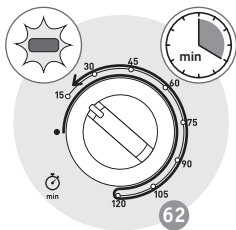

62

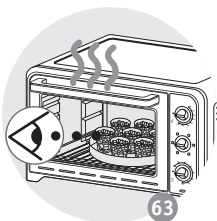

63

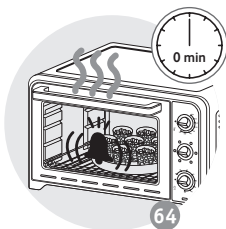

64

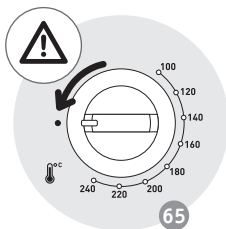

65

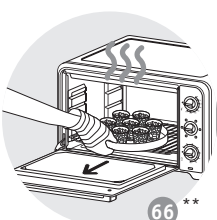

66 **

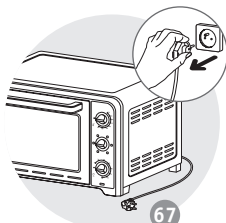

67

** Plat non fourni avec l'appareil
 Schaal niet bij het apparaat inbegrepen
 Platte nicht im Lieferumfang inbegriffen
 The dish is not supplied with the appliance
 El plato no es suministrado con el aparato
 Piatto non fornito con l'apparechio
 Travessa não fornecida com o aparelho

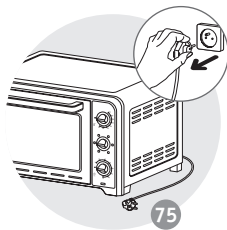
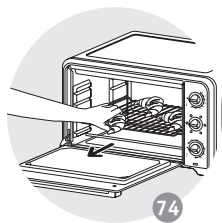
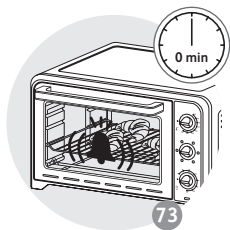
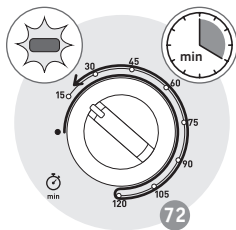
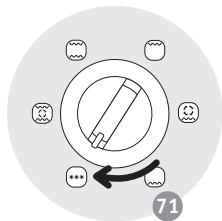
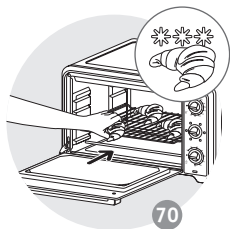
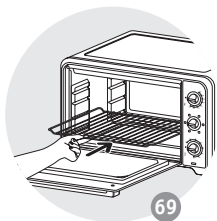
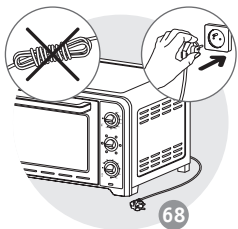

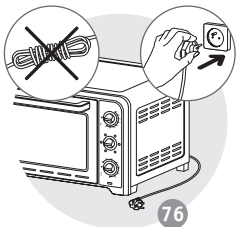
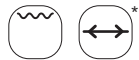

76

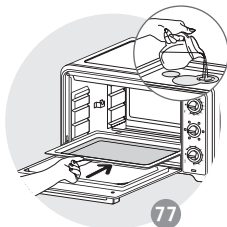

77

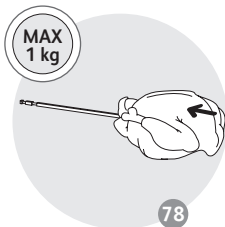

78

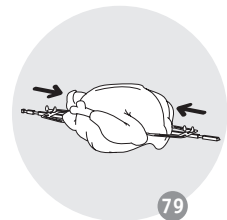

79

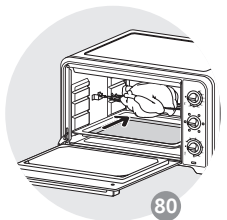

80

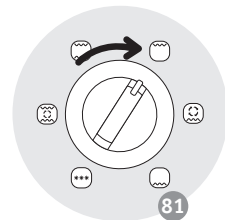

81

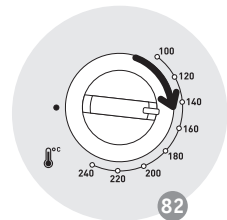

82

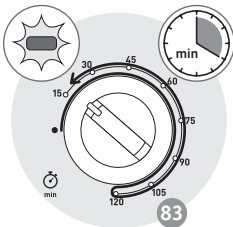

83

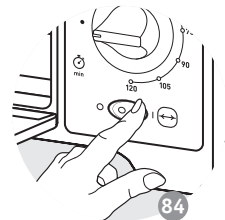

84

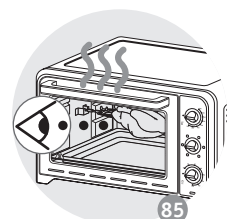

85

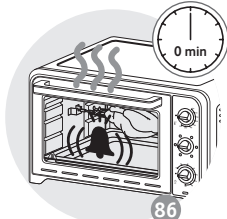

86

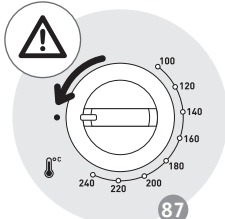

87

* selon modèle - afhankelijk van het model - je nach Modell - depending on the model - según el modelo - in base al modelo - consoante o modelo

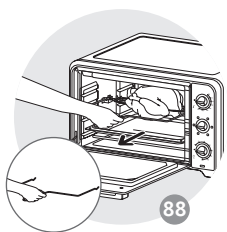

88

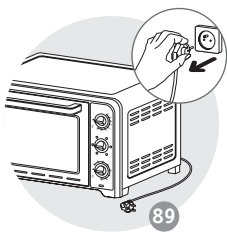

89

9

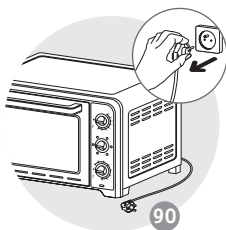

90

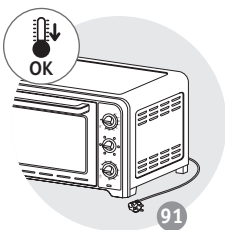

91

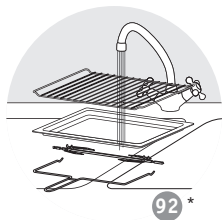

92 *

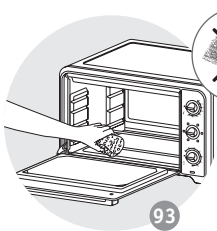

93

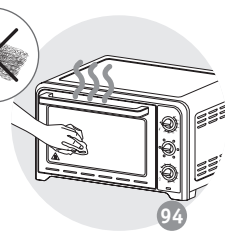

94

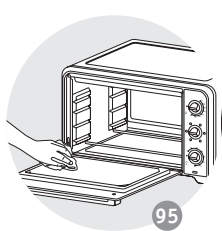

95

* selon modèle - afhankelijk van het model - je nach Modell - depending on the model - según el modelo - in base al modelo - consoante o modelo





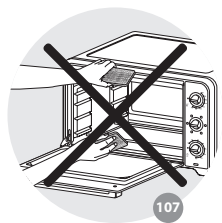
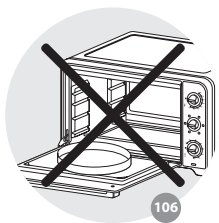
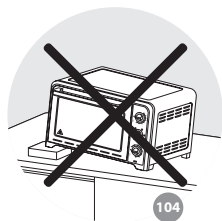
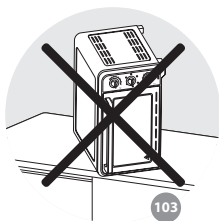
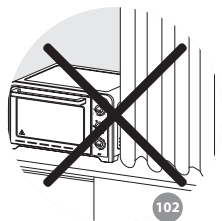
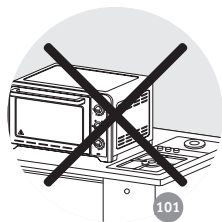
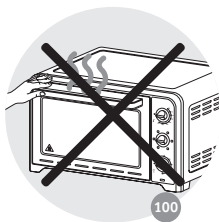
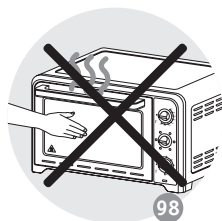
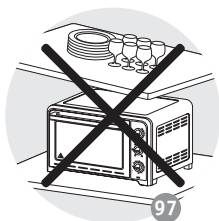
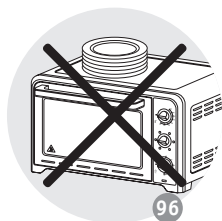

	x 4			10 min	240	20
	1,5 Kg			10 min	230	60
	750 g			10 min	240	30
	1 Kg			-	230	85
	x 4		 	-	240	22 +9
	x 8		 	-	240	15 +5
	350 gr			10 min	210	15
				10 min	240	45
	650 gr			10 min	240	20
				-	240	28
				10 min	200	45
				10 min	200	20
				-	135	45
				10 min	230	50
				10 min	240	30
	1,5 Kg	 		-	240	60

* selon modèle - afhankelijk van het model - je nach Modell - depending on the model - según el modelo - in base al modelo - consoante o modelo



MOULINEX INTERNATIONAL GUARANTEE: COUNTRY LIST

www.moulinex.com

			
ARGENTINA	0800-122-2732	2 años 2 years	GRUPE SEB ARGENTINA S.A. Billinghurst 1833 3° C1425DTK Capital Federal Buenos Aires
ՀԱՅԱՍՏԱՆ ARMENIA	010 55-76-07	2 տարի 2 years	ՓԲԸ «ԳՐՈՒՊԻՆԱ ՍԵԲ» 125171, ՄՈՍԿՎԱ, ԼԵՆԻՆԳՐԱԴՍԿԱՆ ԽՈՒՆԻՆ, 16A, ՇԻՆ.3
AUSTRALIA	1300307824	1 year	GRUPE SEB AUSTRALIA PO Box 7535, Silverwater NSW 2128
ÖSTERREICH AUSTRIA	01 890 3476	2 Jahre 2 years	GRUPE SEB DEUTSCHLAND GmbH / KRUPS GmbH Theodor-Stern-Kai 1 60486 Frankfurt am Main
البحرين BAHRAIN	17291537	1 year	www.moulinex-me.com
БЕЛАРУСЬ BELARUS	017 2239290	2 года 2 years	ЗАО «Группа СЕБ-Восток», 125171, Москва, Ленинградское шоссе, д. 16А, стр. 3
BELGIQUE BELGIE BELGIUM	070 23 31 59	2 ans 2 jaar 2 years	GRUPE SEB BELGIUM SA NV 25 avenue de l'Espérance - ZI 6220 Fleurus
BOSNA I HERCEGOVINA	Info-linija za potrošače 033 551 220	2 godine 2 years	SEB Developpement Predstavništvo u BiH Vrazova 8/II 71000 Sarajevo
BRASIL BRAZIL	11 2915-4400	1 ano 1 year	SEB COMERCIAL DE PRODUTOS DOMÉSTICOS LTDA Rua Venâncio Aires, 433, Pompéia, São Paulo/SP
БЪЛГАРИЯ BULGARIA	0700 10 330	2 години 2 years	ГРУП СЕБ БЪЛГАРИЯ ЕООД бул. България 81 В, ет. 5 1404 София
CANADA	1-800-418-3325	1 an 1 year	GRUPE SEB CANADA 345 Passmore Avenue Toronto, ON, M1V 3N8
CHILE	02 2 884 46 06	2 años 2 years	GRUPE SEB CHILE Comercial Ltda Av. Providencia, 2331, piso 5, oficina 501 Santiago
COLOMBIA	018000520022	2 años 2 years	GRUPE SEB COLOMBIA Apartado Aereo 172, Kilometro 1 Via Zipaquira, Cajica Cundinamarca
HRVATSKA CROATIA	01 30 15 294	2 godine 2 years	SEB mku & p d.o.o. Sarajevska 29, 10000 Zagreb
ČESKÁ REPUBLIKA CZECH REPUBLIC	731 010 111	2 roky 2 years	Grupe SEB ČR s.r.o. Futurama Business Park (budova A) Sokolovská 651/136a 186 00 Praha 8
DANMARK DENMARK	44 663 155	2 år 2 years	GRUPE SEB NORDIC AS Tempovej 27 2750 Ballerup
مصر EGYPT	16622	سنة واحدة 1year	جروب سب انجيت القاهرة: ١٢١ شارع الحجاز، مصر الجديدة (الاسكندرية): طريق ٤ مايو، سموحة
EESTI ESTONIA	668 1286	2 aastat 2 years	GRUPE SEB POLSKA Sp. z o.o. ul. Bukowińska 22b 02-703 Warszawa
SUOMI FINLAND	09 622 94 20	2 Vuotta 2 years	Grupe SEB Finland Kutojanitie 7 02630 Espoo
France Continentale + Guadeloupe, Martinique, Réunion, Saint-Martin	09 74 50 10 14	2 ans 2 years	GRUPE SEB France Service Consommateur Moulinex 112 Ch. Moulin Carron, TSA 92002 69134 ECULLY Cedex
DEUTSCHLAND GERMANY	0212 387 400	2 Jahre 2 years	GRUPE SEB DEUTSCHLAND GmbH / KRUPS GmbH Theodor-Stern-Kai 1 60486 Frankfurt am Main

ELLADA GREECE	2106371251	2 χρόνια 2 years	SEB GROUPE ΕΛΛΑΔΟΣ Α.Ε. Οδός Καβαλιέρηδου 7 Τ.Κ. 145 64 Κ. Κηφισιά
香港 HONG KONG	8130 8998	1 year	SEB ASIA Ltd. Room 903, 9/F, South Block, Skyway House 3 Sham Mong Road, Tai Kok Tsui, Kowloon, Hong-Kong
MAGYARORSZÁG HUNGARY	06 1 801 8434	2 év 2 years	GROUPE SEB CENTRAL-EUROPE Kft. Táviró köz 4 2040 Budaörs
INDONESIA	+62 21 5793 7007	1 year	GROUPE SEB INDONESIA (Representative office) Sudirman Plaza, Plaza Marein 8th Floor JL Jendral Sudirman Kav 76-78, Jakarta 12910, Indonesia
ITALIA ITALY	1 99 207 892	2 anni 2 years	GROUPE SEB ITALIA S.p.A. Via Montefeltro, 4 20156 Milano
日本 JAPAN	0570-077772	1 year	株式会社グループセブジャパン 〒144-0042 東京都大田区羽田旭町11-1 羽田クロノゲート事務棟5F
الأردن JORDAN	4629700	1 year	www.moulinex-me.com
ҚАЗАҚСТАН KAZAKHSTAN	727 378 39 39	2 жыл 2 years	ЖАҚ «Группа СЕБ- Восток» 125171, Москва, Ленинградское шоссе,16А, 3 үйі
한국어 KOREA	1588-1588	1 year	(유)그룹 세브 코리아 서울시 중로구 청계천로35 관정빌딩 2층 110-790
الكويت KUWAIT	24834787	1 year	www.moulinex-me.com
LATVJA LATVIA	6 616 3403	2 gadi 2 years	GROUPE SEB POLSKA Sp. z o.o. ul. Bukowińska 22b, 02-703 Warszawa
لبنان LEBANON	1364392	1 year	www.moulinex-me.com
LIEUVA LITHUANIA	5 214 0057	2 metai 2 years	GROUPE SEB POLSKA Sp. z o.o. ul. Bukowińska 22b, 02-703 Warszawa
LUXEMBOURG	0032 70 23 31 59	2 ans 2 years	GROUPE SEB BELGIUM SA NV 25 avenue de l'Espérance - ZI 6220 Fleurus
МАКЕДОНИЈА MACEDONIA	(02) 20 50 319	2 години 2 years	ГРУП СЕБ БЪЛГАРИЈА ЕООД бул. България 81 В, ет. 5 1404 София
MALAYSIA	603 7802 3000	1 year	GROUPE SEB MALAYSIA SDN. BHD Unit No. 402-403, Level 4, Uptown 2, No. 2, Jalan SS21/37, Damansara Uptown, 47400, Petaling Jaya, Selangor D.E. Malaysia
MEXICO	(01800) 112 8325	1 año 1 year	Groupe S.E.B. México, S.A. DE C.V. Goldsmith 38 Desp. 401, Col. Polanco Delegación Miguel Hidalgo 11 560 México D.F.
MOLDOVA	22 929249	2 роки 2 years	ТОВ «Група СЕБ Україна» 02121, Харківське шосе, 201-203, 3 поверх, Київ, Україна
NEDERLAND The Netherlands	0318 58 24 24	2 jaar 2 years	GROUPE SEB NEDERLAND B.V. De Schutterij 27 3905 PK Veenendaal
NEW ZEALAND	0800 700 711	1 year	GROUPE SEB NEW ZEALAND PO Box 17 – 298, Greenlane, 1546 Auckland New Zealand

NORGE NORWAY	815 09 567	2 år 2 years	GRUPE SEB NORDIC AS Tempovej 27 2750 Ballerup
عمان سلطنة OMAN	80075000	1 year	www.moulinex-me.com
POLSKA POLAND	801 300 420 koszt jak za połączenie lokalne	2 lata 2 years	GRUPE SEB POLSKA Sp. z o.o. ul. Bukowińska 22b 02-703 Warszawa
PORTUGAL	808 284 735	2 anos 2 years	GRUPE SEB IBÉRICA SA Urb. da Matinha Rua Projectada à Rua 3 Bloco1 - 3° B/D 1950 - 327 Lisboa
قطر QATAR	44558796	1 year	www.moulinex-me.com
REPUBLIC OF IRELAND	01 677 4003	1 year	GRUPE SEB IRELAND Unit B3 Aerodrome Business Park, College Road, Rathcoole, Co. Dublin
ROMANIA	0 21 316 87 84	2 ani 2 years	GRUPE SEB ROMÂNIA Str. Emil Pangratti nr. 13 011881 București
РОССИЯ RUSSIA	495 213 32 29	2 года 2 years	ЗАО «Группа СЕБ-Восток», 125171, Москва, Ленинградское шоссе, д. 16А, стр. 3
السعودية العربية المملكة SAUDI ARABIA	920023701	2 years	www.moulinex-me.com
SRBIJA SERBIA	060 0 732 000	2 godine 2 years	SEB Developpement Đorđa Stanojevića 11b 11070 Novi Beograd
SINGAPORE	6550 8900	2 years	GRUPE SEB SINGAPORE Pty Ltd. 59 Jalan Pemimpin, #04-01/02 L&Y Building Singapore 577218
SLOVENSKO SLOVAKIA	232 199 930	2 roky 2 years	GRUPE SEB Slovensko, spol. s r.o. Cesta na Senec 2/A 821 04 Bratislava
SLOVENIJA SLOVENIA	02 234 94 90	2 leti 2 years	SEB d.o.o. Gregorčičeva ulica 6 2000 MARIBOR
SOUTH AFRICA	0100201730	1 year	GS South Africa Building 17, PO BOX 107 The Woodlands Office Park, 20 Woodlands Drive, Woodmead 2080
ESPAÑA SPAIN	902 31 22 00	2 años 2 years	GRUPE SEB IBÉRICA S.A. C/ Almogàvers, 119-123, Complejo Ecuruban, 08018 Barcelona
SVERIGE SWEDEN	08 594 213 30	2 år 2 years	TEFAL SVERIGE SUBSIDIARY OF GROUPE SEB NORDIC Truckvägen 14 A, 194 52 Upplands Väsby
SUISSE SCHWEIZ SWITZERLAND	044 837 18 40	2 ans 2 Jahre 2 years	GRUPE SEB SCHWEIZ GmbH Thurgauerstrasse 105 8152 Glattpark
ประเทศไทย THAILAND	02 769 7477	2 years	GRUPE SEB THAILAND 2034/66 Italthai Tower, 14th Floor, n° 14-02, New Phetchburi Road, Bangkapi, Huaykwang, Bangkok, 10320
TÜRKIYE TURKEY	444 40 50	2 YIL 2 years	GRUPE SEB ISTANBUL AS Dereboyu Cd. Bilim Sk. Sun Plaza No:5 K:2 Masiak 34398 Istanbul

المملكة العربية المتحدة الإمارات UAE	8002272	1 Year	www.moulinex-me.com
Україна UKRAINE	044 300 13 04	2 роки 2 years	ТОВ «Групи СЕБ Україна» 02121, Харківське шосе, 201-203, 3 поверх, Київ, Україна
UNITED KINGDOM	0345 602 1454	1 year	GROUPE SEB UK LTD Riverside House, Riverside Walk Windsor, Berkshire, SL4 1NA
U.S.A.	800-395-8325	1 year	GROUPE SEB USA 2121 Eden Road Milville, NJ 08332
VENEZUELA	0800-7268724	2 años 2 years	GROUPE SEB VENEZUELA Av Eugenio Mendoza, Centro Letonia, Torre ING Bank, Piso 15, Ofc 155 Urb. La Castellana, Caracas

www.moulinex.com

22/12/2015

MOULINEX INTERNATIONAL GUARANTEE

Date of purchase: / Date d'achat / Fecha de compra / Data da compra / Data d'acquisto / Kaufdatum / Aankoopdatum / Købsdato / Inköpsdatum / Kjøpsdato / Ostopňavá / Data zakupu / Data vânzării / Įsigijimo data/ Ostukouplev / Datum nákupu / Sorozatszám / Datum nákupu / Prikama datum / Datum Kupovine / Datum kajprie / Data cumpărării / Datum nákupu / Tarihik pembelian / Tanggal pembelian / Ngay mua hàng / Satun alma tarihi / Дата продаж / Дата на закупуване / Датум на купување / Сатпаган мерили / Ημερομηνία αγοράς / Ανακτήσιμη ημερ / 購買日期 / 購入日 / 구입일자 / تاريخ الشراء / تاريخ خري / تاريخ المنتج الكفالت

Product reference: / Référence du produit / Referencia del producto / Nome do produto / Tipo de produto / Typnummer des Gerätes / Artikelnummer van het apparaat / Referencenummer / Produktreferens / Artikelnummer / Tuotenumero / referencia produktu / Model / Gaminio numeris / Toote viitenumber / Tip aparata / Visiārlās kelte / Typ výrobku / Produkta atsauces numurs / Model proizvoda / Oznaka proizvoda / Cod produs / Produk rujukan / Referensi produk / Mã sản phẩm / Ürün koda / Model / Модель / Модел на уреда / Модел / Κωδικός προϊόντος / Уంటық / 產品型號 / 製品レファレンス番号 / 型号 / مرجع المنتج الكفالت / مرجع المنتج الكفالت

Retailer name & address: / Nom et adresse da vendeur / Nombre y dirección del minorista / Nome e endereço do revendedor / Nome e indirizzo del negozio / Name und Anschrift des Händlers / Naam en adres van de dealer / Förhandlar namn & adresse / Återförsäljarens namn och adress / Forhandler navn og adresse / Jäiltenmyyjän nimi ja osoite / nazwa i adres sprzedawcy / Numele și adresa vânzătorului / Pardautovēs pavadināmas ir adresas / Mijūta kaupjas ja address / Naziv i naslov trgovine / Tippasuzám / Nazov a adresa predajcu / Veikala nosaukums un adrese / Naziv i adresa prodavca / Naziv i adresa prodavca / Naziv i adresa prodajnog mjesta / Nume și adresa vânzător / Název a adresa prodávce / Nama dan alamat penjual / Nama Toko Penjual dan alamat / Tên và địa chỉ cửa hàng bán / Satei firmam ad v adresa / Nazivno i adresa prodavca / Hama i adresa prodavca / Търговски обект / Hama i adresa na prodavnicata / Сагулманы аты және мекен-жайы / Епоуықта хат белгілерін көрсетілетін жер / ևանաանի անվանումը և հասցեն / 常售商店名和地址 / 販売店の名前、住所 / 소매점 이름과 주소 / 판매처 이름과 주소 / اسم و عنوان بائع التجزئة و عنوانه / نام تاجر خرده فروشی / اسم بائع التجزئة و عنوانه

Distributor stamp: / Cachet distributeur / Sello del distribuidor / Carimbo do revendedor / Timbro del negozio / Händlerstempel / Stempel van de dealer / Forhandler stempel / Återförsäljarens stämpel / Forhandler stempel / Jäiltenmyyjän leima / pieczęć sprzedawcy / Štamplika vânzătorului / Anspaudas / Tempel / Žig trgovine / Eladó neve, címe / Raziko predajcu / Značgs / Pečat malprodajce / Pečat prodavca / Pečat prodajnog mjesta / Štamplika vânzătorului / Raziko prodavca / Car pečenci / Car dari Toko Penjual / Cua hàng bán đóng dấu / Satei Firmam Kaşesi / Печать prodavca / Печат prodavca / Печат на търговския обект / Печат на prodavnicata / Сагулманы мөрү / Сагулманы көрсөткүчү / ևանաանի կիզիկ / 常售商店的蓋印 / 販売店印 / 소매점 직인 / اسم بائع التجزئة / مهر خرده فرو / اسم بائع التجزئة و عنوانه

NC00133909-03