

ultracompact

sandwich

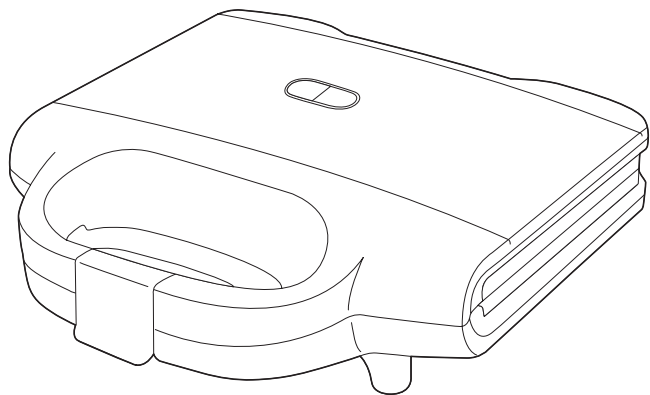

FR
NL
DE
IT
ES
PT
EN
EL
TR
DA
NO
SV
FI
PL
RU
UK
CS
SK
HU
SL
SR
BS
HR
RO
BG
ET
LT
LV
AR
FA
KK
VI
ZH

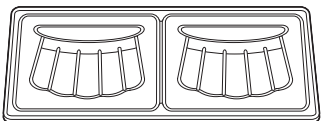
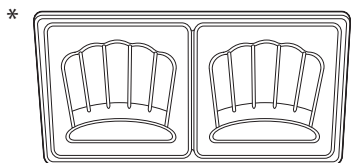
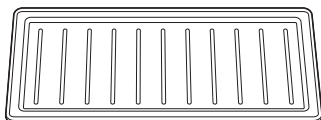
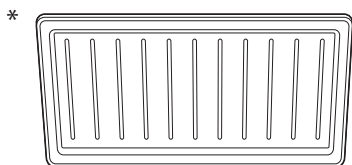
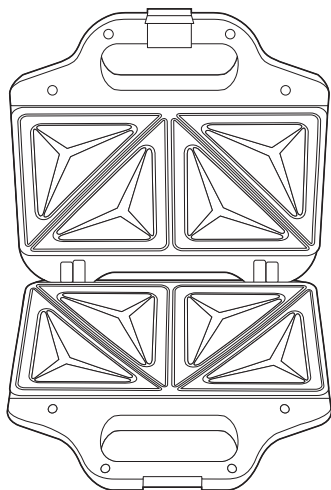
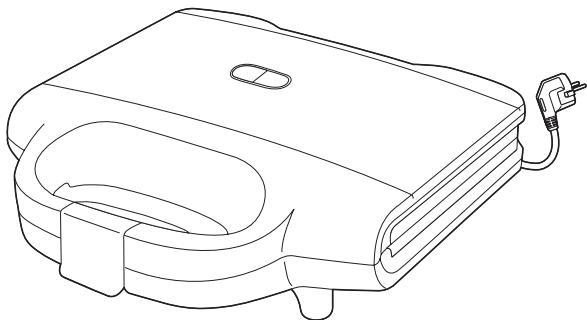

*selon modèle - afhankelijk van het model - je nach Modell - secondo il modello - según modelo - consoante o modelo - depending on the model - Ανάλογα με το μοντέλο - modele göre - afhængig af modellen - avhengig av modell - beroende på modell - mallista riippuen - w zależności od modelu - в зависимости от модели - залежно від моделі - podle modelu - podľa modelu - modelttöi fúggöen - glede na model - u zavisnosti od modela - zavisno od modela - ovisno o modelu - in función de model - в зависимости от модели - söltuvalt mudelist - priklausomai nuo modelio - Atkarībā no modeļa - حسب الموديل - بر حسب مدل - үлгісіне қарай - Туу

1

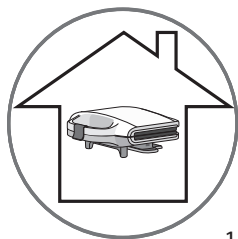

1



2

2

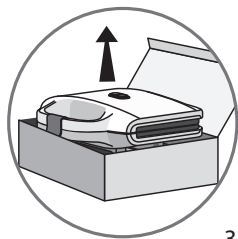
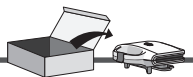

3



4



5

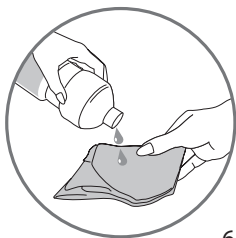

6



7



8

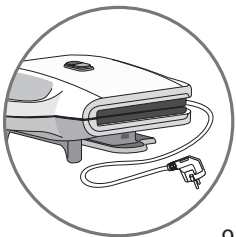

9

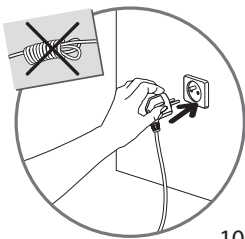

10

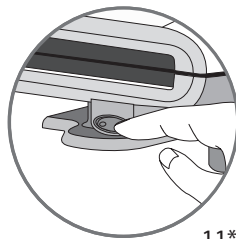

11*

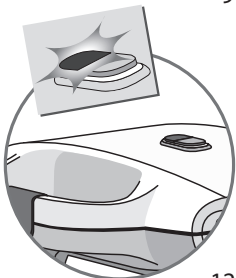

12

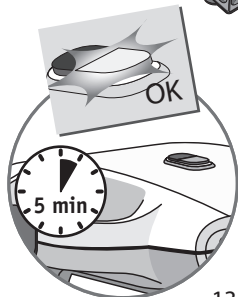

13

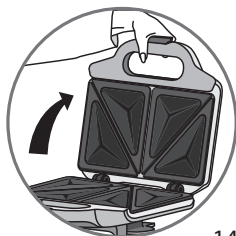

14



15

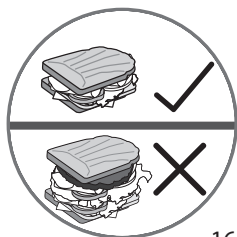

16



17

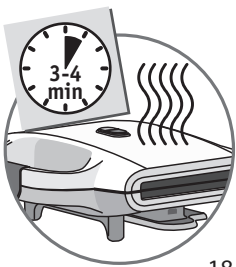

18



19



20

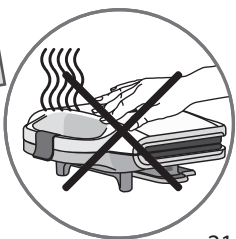

21

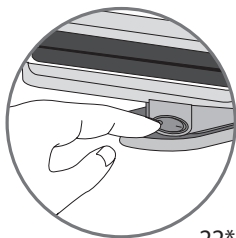

22*

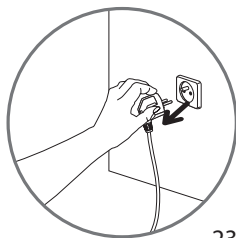

23

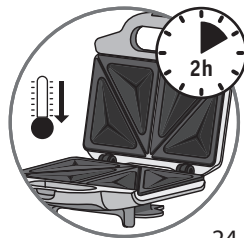

24



25

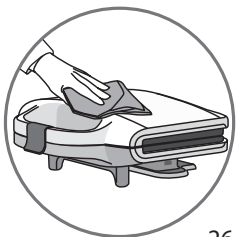

26

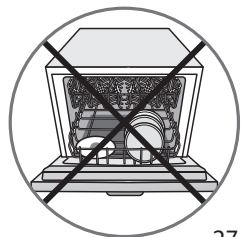

27

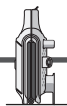

28

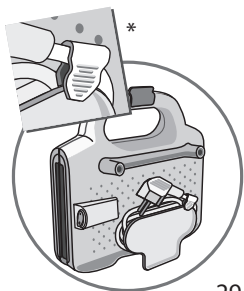

29

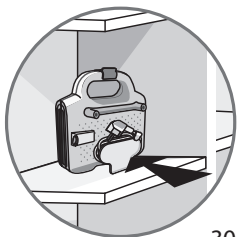

30

NC00151913