

Rowenta®



MANUEL D'UTILISATION / BEDIENUNGSANLEITUNG / GEBRUIKSAANWIJZING / MANUALE D'USO / MANUAL DEL OPERADOR / MANUAL DE UTILIZAÇÃO / ΕΓΧΕΙΡΙΔΙΟ ΛΕΙΤΟΥΡΓΙΑΣ / ПОСІБНИК З ЕКСПЛУАТАЦІЇ / NÁVOD K OBSLUZE / NÁVOD NA POUŽITIE / KEZELÉSI ÚTMUTATÓ / MANUAL DE UTILIZARE / РЪКОВОДСТВО ЗА ЕКСПЛОАТАЦИЯ / PRIRUČNIK ZA RUKOVANJE / PRIROČNIK ZA UPORABO / UPUTSTVO ZA RAD / UPUTSTVO ZA UPOTREBU / OPERATING MANUAL



**Merci d'avoir choisi un aspirateur
sans fil Rowenta.
Pour lire votre manuel en français,
rendez-vous sur la page 4.**

Vielen Dank, dass Sie sich für einen kabellosen Staubsauger von Rowenta entschieden haben.
Die Gebrauchsanweisung in deutscher Sprache finden Sie auf Seite **14**.

Bedankt dat u hebt gekozen voor een draadloze stofzuiger van Rowenta.
Ga naar pagina **24** voor de Nederlandstalige gebruiksaanwijzing.

Grazie per aver scelto l'aspirapolvere senza fili di Rowenta. Per leggere il tuo manuale in italiano vai a pagina **34**.

Gracias por elegir la aspiradora sin cable de Rowenta. Para leer el manual en Español, ve a la página **44**.

Obrigado por escolher o aspirador sem fios Rowenta. Para ler o manual em português, aceda à página **54**.

Ευχαριστούμε που επιλέξατε την ηλεκτρική σκούπα Rowenta χωρίς καλώδιο. Για να διαβάσετε το εγχειρίδιό σας στα αγγλικά, μεταβείτε στη σελίδα **64**.

Дякуємо, що обрали акумуляторний пилосос Rowenta. Щоб прочитати посібник українською мовою, перейдіть на сторінку **74**.

Děkujeme, že jste si vybrali bezdrátový vysavač Rowenta. Pokud si chcete přečíst příručku v češtině, přejděte na stranu **84**.

Ďakujeme vám, že ste sa rozhodli pre bezšnúrový vysávač Rowenta. Ak si chcete návod prečítať v anglickom jazyku prejdite na stranu **94**.

Köszönjük, hogy a Rowenta vezeték nélküli porszívót választotta. A kézikönyv angol nyelvű változata a **104**. oldalon olvasható.

Vă mulțumim că ați ales aspiratorul fără fir Rowenta. Pentru a citi manualul în română, mergeți la pagina **114**.

Благодарим Ви, че избрахте безкабелната прахосмукачка Rowenta. За да прочетете ръководството на български език, отидете на страница **124**.

Hvala što ste se odlučili za bežični usisivač Rowenta. Za čitanje priručnika na engleskom prijedite na **134**. stranicu.

Hvala, da ste izbrali brezžični sesalnik za prah Rowenta. Če želite navodila za uporabo v angleškem jeziku, pojdite nastran **144**.

Hvala vam što ste izabrali Rowenta bežični usisivač. Da biste pročitali uputstvo na srpskom, idite na stranicu **154**.

Hvala što ste izabrali Rowenta bežični štapni usisivač. Uputstvo na engleskom možete pročitati na strani **164**.

Thank you for choosing Rowenta cordless vacuum cleaner. To read your manual in English go to page **174**.



Merci d'avoir choisi un aspirateur sans fil Rowenta.

Votre appareil est équipé des dernières technologies Rowenta.

Lisez attentivement le manuel afin d'utiliser au mieux votre nouvel aspirateur.

Veuillez scanner ce code avec votre téléphone ou lecteur de QR codes pour visualiser comment assembler votre appareil.



ASSEMBLAGE



Attention !
Une action à faire avant le 1^{er} usage
 voir page 6.

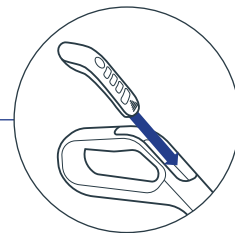
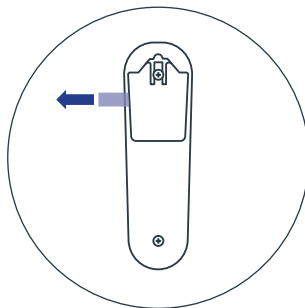

VOTRE APPAREIL DOIT ÊTRE COMPLÈTEMENT CHARGÉ AVANT LA PREMIERE UTILISATION

Connectez le jack avant de le brancher.

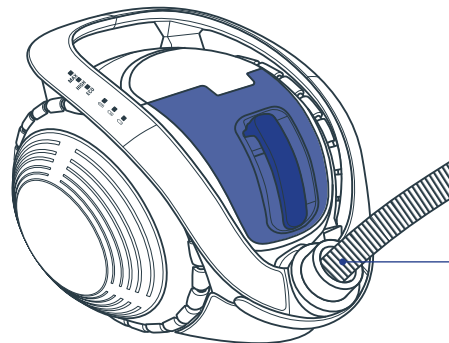
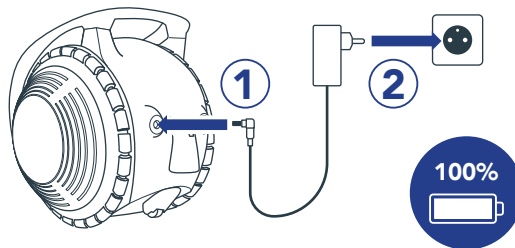

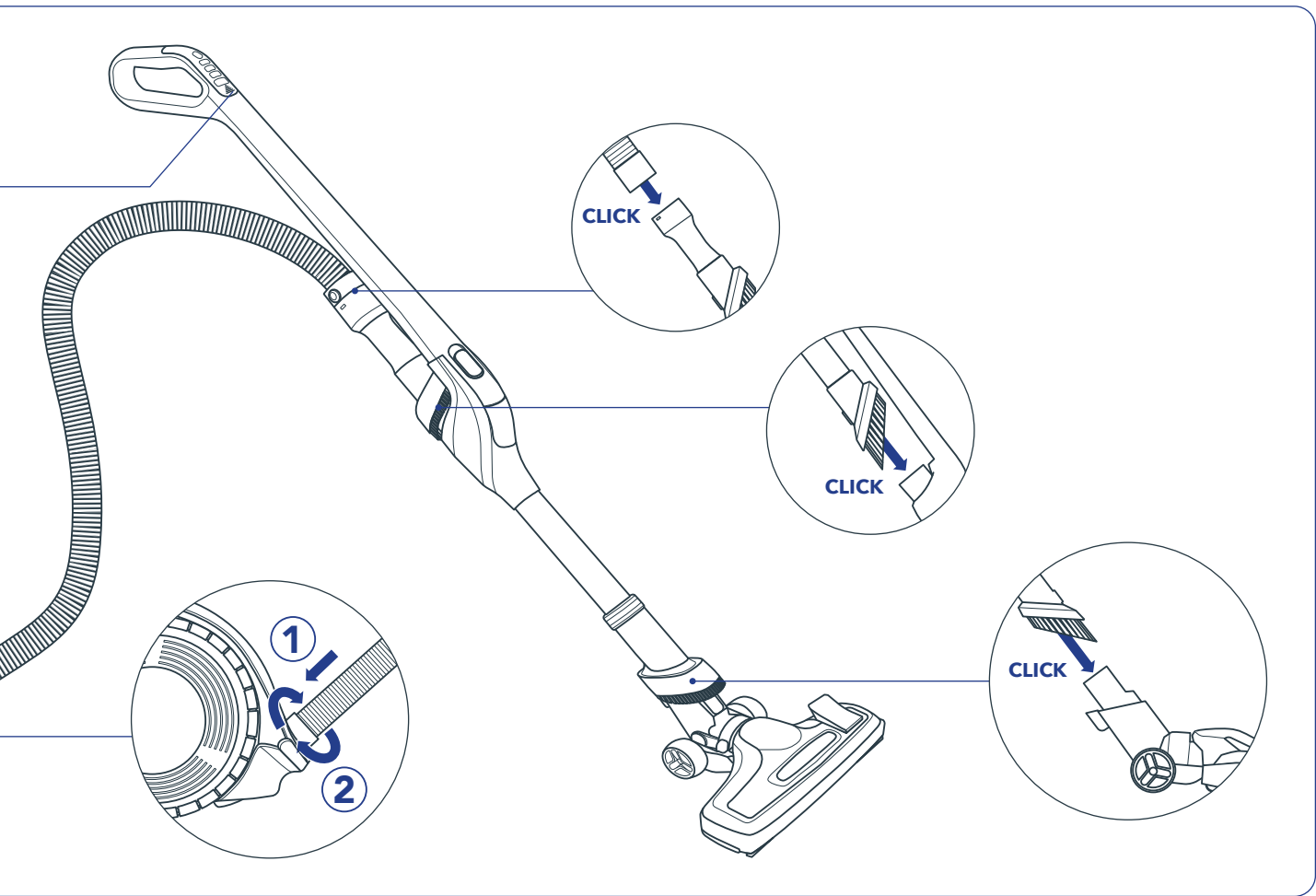

AVANT LA 1^{ÈRE} UTILISATION



Apparez votre télécommande avant la première utilisation.

À faire une seule fois.

	Ce que vous devez faire :	Ce qu'il se passe sur votre appareil :
1	Retirez la languette en plastique de la télécommande.	
2	Allumez votre appareil : Appuyez sur le bouton marche/arrêt.	Les LEDs batterie bleues s'allument.
3.1	Lancez l'appairage : Appuyez en même temps sur les boutons MAX et II .	- Vous entendez un bip de confirmation - Les LEDs batterie bleues et les LEDs vitesse vertes clignotent alternativement
3.2	Confirmez l'appairage : Appuyez immédiatement après l'étape 3.1 sur le bouton II (pendant que les LEDs clignotent alternativement).	- Les LEDs bleues restent allumées - Vous entendez un double bip Si vous n'avez pas entendu de double bip au bout de 10 secondes : l'appairage a échoué. Éteignez votre appareil et recommencez à partir de l'étape 2.

➤ Félicitations ! Vous avez réussi à appairer votre télécommande.

BOUTON MARCHE / ARRÊT

Pour allumer ou éteindre votre appareil, appuyez sur le bouton de démarrage. Pour commencer à aspirer, appuyez sur le bouton ECO, HIGH ou MAX de votre télécommande.

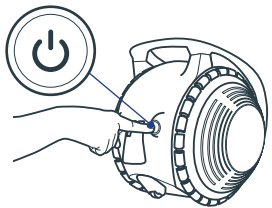

MODES DE PUISSANCE

Votre appareil dispose de 4 modes de puissance. Changez le mode de nettoyage en utilisant votre télécommande et en ajustant la puissance.

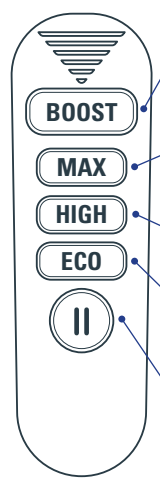

- BOOST : 5/10min***
Pour les nettoyages intensifs et la poussière incrustée en mode BOOST.
NB : Gardez le doigt appuyé sur le bouton BOOST pour utiliser ce mode.
- MAX : 20/40min***
Pour les nettoyages intensifs et la poussière incrustée. Idéal pour tous types de tapis et moquettes.
- HAUTE : 40/50/90min***
Pour usage courant. Idéal pour tous types de sols durs.
- ECO : 1h10/1h30/2h40min***
Pour l'aspiration des poussières fines et des surfaces délicates : étagères, cadres, rideaux etc.
- PAUSE :**
Arrêt temporaire lors d'une session de nettoyage.

Les diodes indiquent les modes de puissance. En mode BOOST, les 3 LEDs clignotent simultanément.

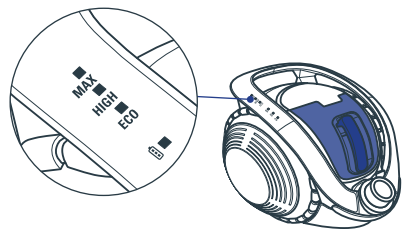

*selon modèle.

TÊTE D'ASPIRATION

Votre tête d'aspiration dispose de 2 modes : tapis et sol dur. Appuyez sur la pédale pour sélectionner la position dont vous aurez besoin pour effectuer votre session de nettoyage.

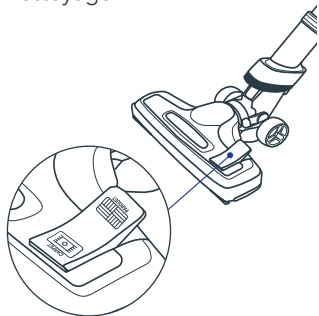

PARQUET

La position «sol dur» est compatible avec les sols en parquet, le carrelage, le lino etc.



TAPIS

La position «tapis» est parfaite pour une aspiration en profondeur sur tout type de moquette ou tapis.

TÉLÉCOMMANDE

Votre appareil fonctionne avec une télécommande intégrée dans le manche. La télécommande s'alimente avec une pile ronde de type CR 2032.

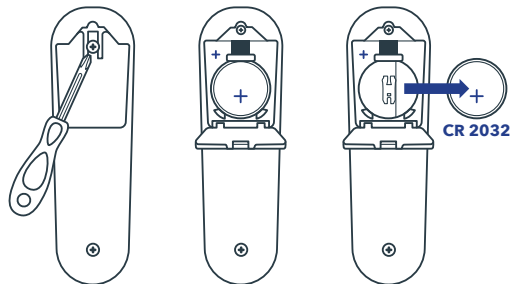

Il est recommandé de changer la pile tous les 18 mois.

En cas de perte ou de dysfonctionnement de votre télécommande, vous pouvez toujours mettre en marche votre appareil en appuyant de manière prolongée sur le bouton marche / arrêt.

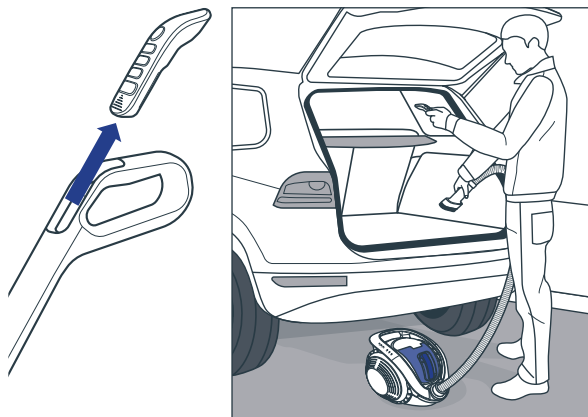

Vous pouvez détacher votre télécommande pour effectuer toutes vos sessions de nettoyage uniquement avec le flexible (idéal par exemple pour nettoyer votre voiture).

Comment utiliser
ma télécommande ?



BATTERIE ET CHARGEMENT



LE CHARGEMENT COMPLET DE LA BATTERIE PREND 4H00

Pour effectuer le chargement de votre batterie, 2 choix s'offrent à vous :

OPTION 1

Branchez directement le chargeur sur votre appareil : insérez d'abord le jack, puis branchez.

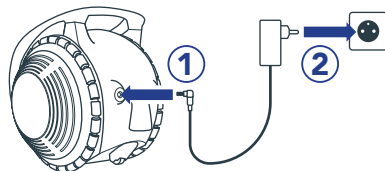

OPTION 2

Branchez le chargeur sur la batterie. Pour ce faire, il vous faut retirer la batterie de votre appareil, insérer le jack puis brancher le chargeur.

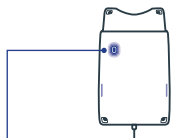
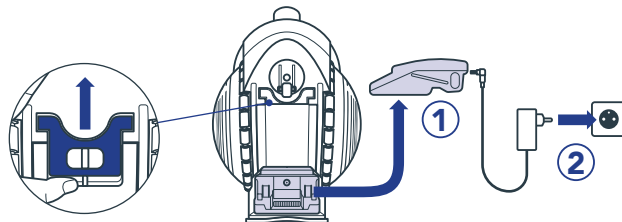

Lumière bleue allumée :
la batterie est en train
de charger.

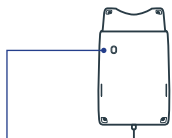

Lumière bleue éteinte :
la batterie est chargée.

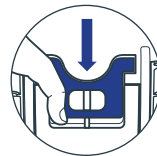
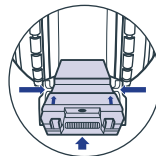

Scannez pour en savoir
plus sur la batterie et son
chargement.



NIVEAUX DE BATTERIE

Votre appareil indique les différents niveaux de chargement :

- 3 LEDs bleues allumées : chargement à 100%.
- 2 LEDs bleues allumées : chargement à 60%.
- 1 LED allumée : votre appareil doit être chargé immédiatement.

Si la batterie est complètement déchargée, 1 LED bleue clignotera.

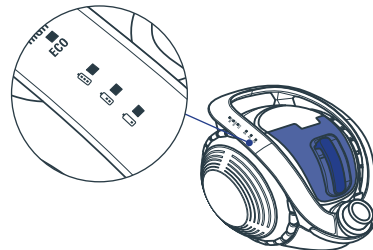

FONCTION FLEX

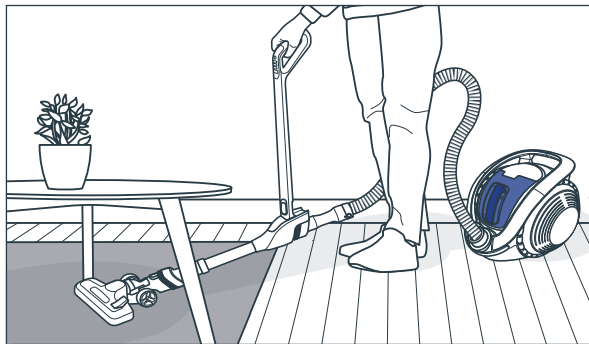

Votre appareil est équipé de la technologie Flex qui vous permettra un nettoyage au plus loin et sans effort sous vos meubles bas.

Pour l'enclencher, faites glisser le bouton Flex vers le haut.

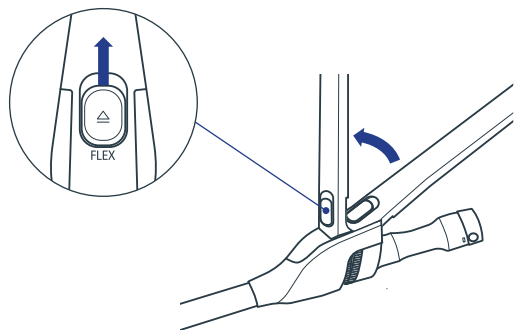

ACCESSOIRES

Votre appareil dispose de 2 brosettes de nettoyage intégrées. Vous pouvez les utiliser pour aspirer la majorité de vos surfaces.

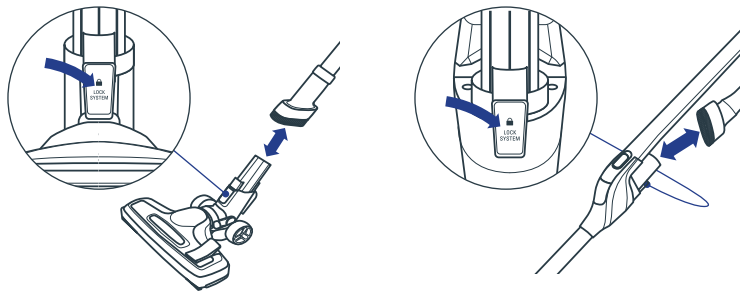

Pour les nettoyages spécifiques, utilisez vos accessoires; insérez-les dans les embouts du tube.

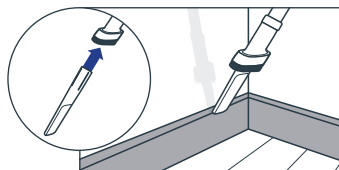

Utilisez le **suceur fente** pour aspirer les endroits étroits.

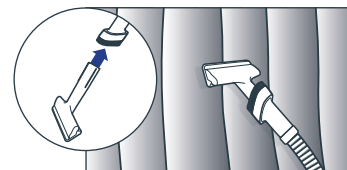

Utilisez la **brosse sofa** pour aspirer vos textiles comme les fauteuils, les rideaux ou les matelas.

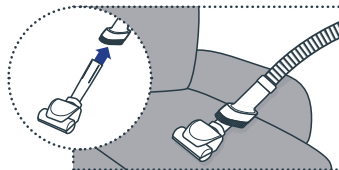

Utilisez la **mini turbo brosse en vitesse MAX ou BOOST pour aspirer en profondeur les fauteuils, les matelas ou les tapis de voiture.

X-Ô

ENTRETIEN

Veuillez scanner ce code avec votre téléphone ou lecteur de QR codes pour avoir les meilleurs conseils sur l'entretien de votre appareil.



VIDAGE DU BOL

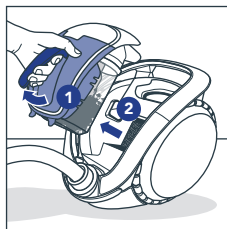
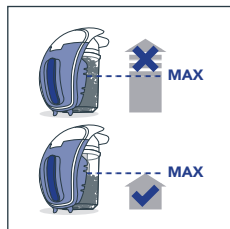

ENTRETIEN DU FILTRE

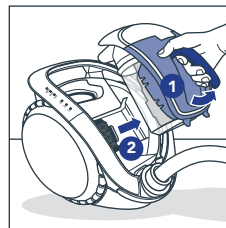
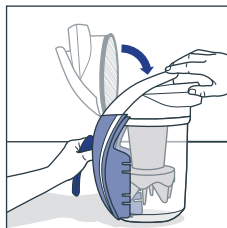
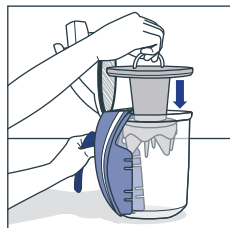
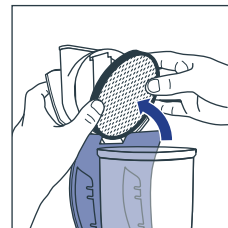
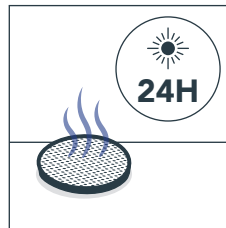
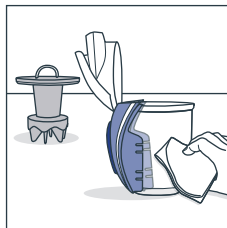
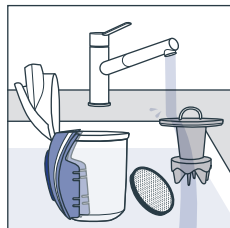

Nettoyez votre filtre après chaque vidage du bol. Le remplacer une fois par an. Pour acheter un nouveau filtre, recherchez la référence Rowenta ZR007700.

ENTRETIEN DU FILTRE MOTEUR

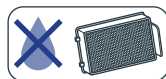

1X
MOIS

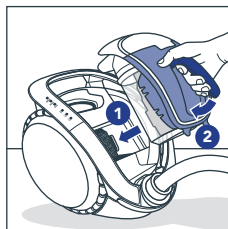
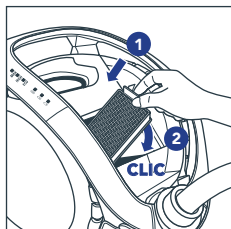
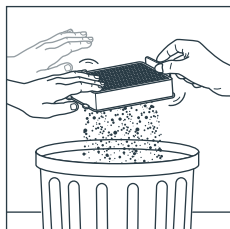
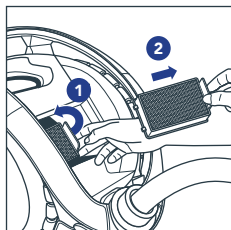
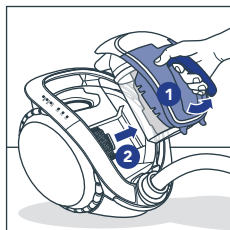

1X
AN

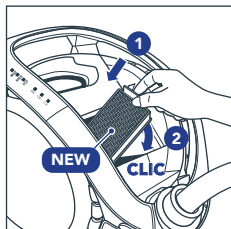
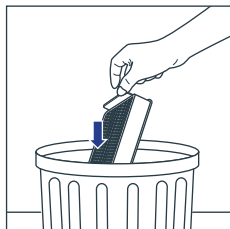

Remplacez le filtre moteur une fois par an.

Pour acheter un nouveau filtre, recherchez la référence Rowenta ZR007700.

NETTOYAGE DE LA MINI TURBO BROSSE

Retirez toujours votre accessoire mini turbo brosse avant nettoyage (disponible uniquement sur certains modèles).

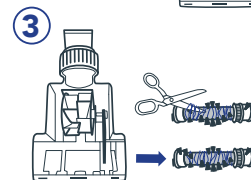
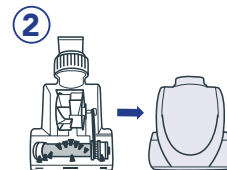

RANGEMENT

OPTION 1

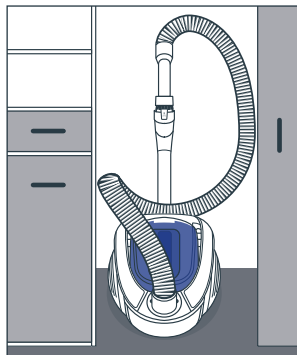
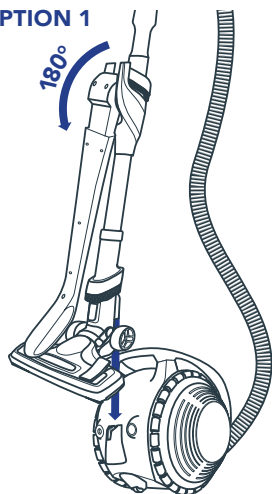

OPTION 2

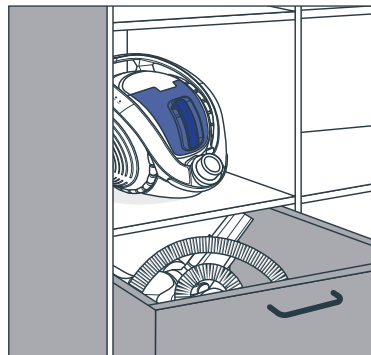
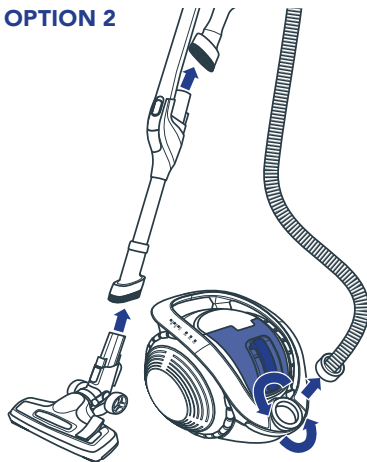

ATTENTION

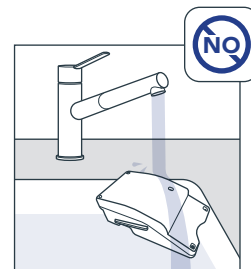

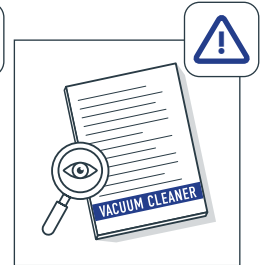
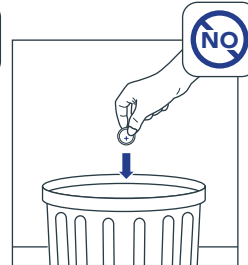
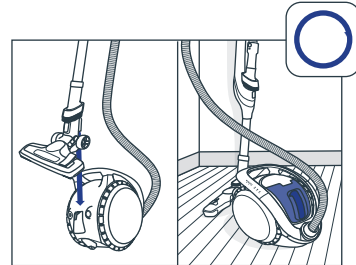
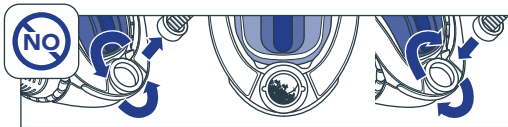
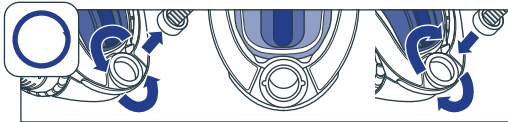
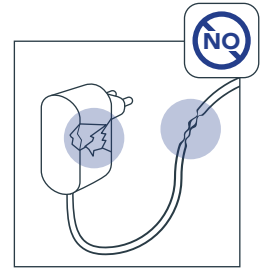
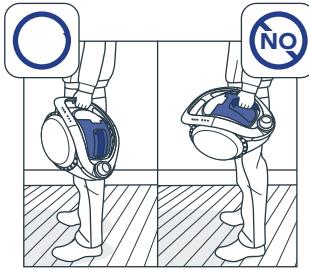
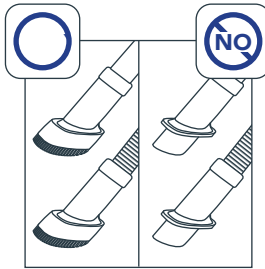
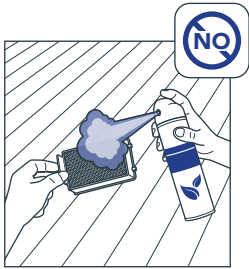
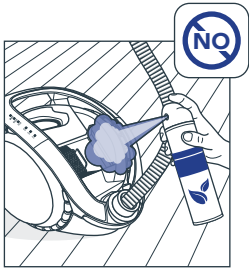
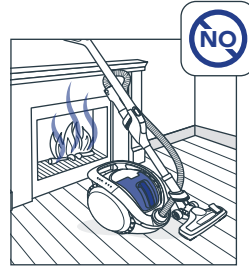
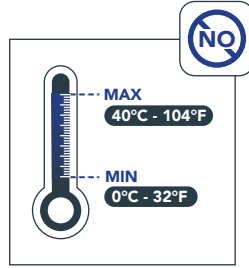



Vielen Dank, dass Sie sich für den Kauf eines Rowenta X-Ö entschieden haben. Ihr Gerät ist mit den neuesten Rowenta-Technologien ausgestattet.

Lesen Sie diese Anleitung sorgfältig durch, um bestmöglich von Ihren Gerätekapazitäten zu profitieren.

Scannen Sie mit Ihrer Handykamera oder Ihrem QR-Reader, um die hilfreiche Videoanleitung zur Montage des Geräts anzusehen



ZUSAMMENBAUEN



Warnung!
Auf Seite 16 finden Sie Anweisungen, die vor dem ersten Gebrauch zu befolgen sind.

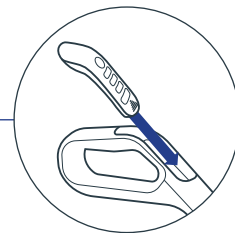
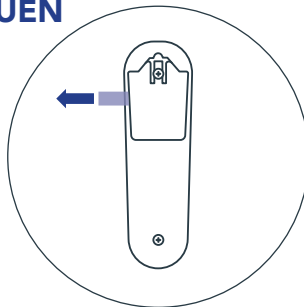

DAS GERÄT MUSS VOR DEM ERSTEN GEBRAUCH VOLLSTÄNDIG AUFGELADEN WERDEN

Schließen Sie die Buchse an, bevor Sie mit dem aufladen beginnen.

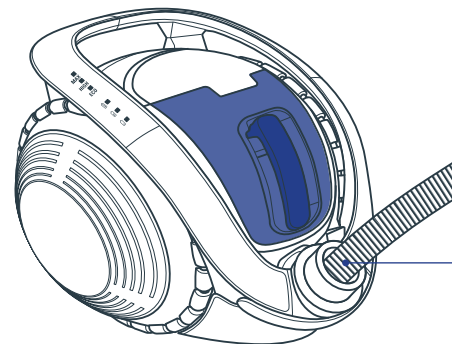
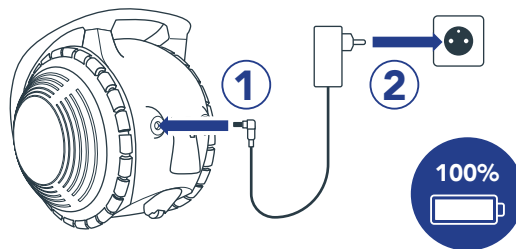

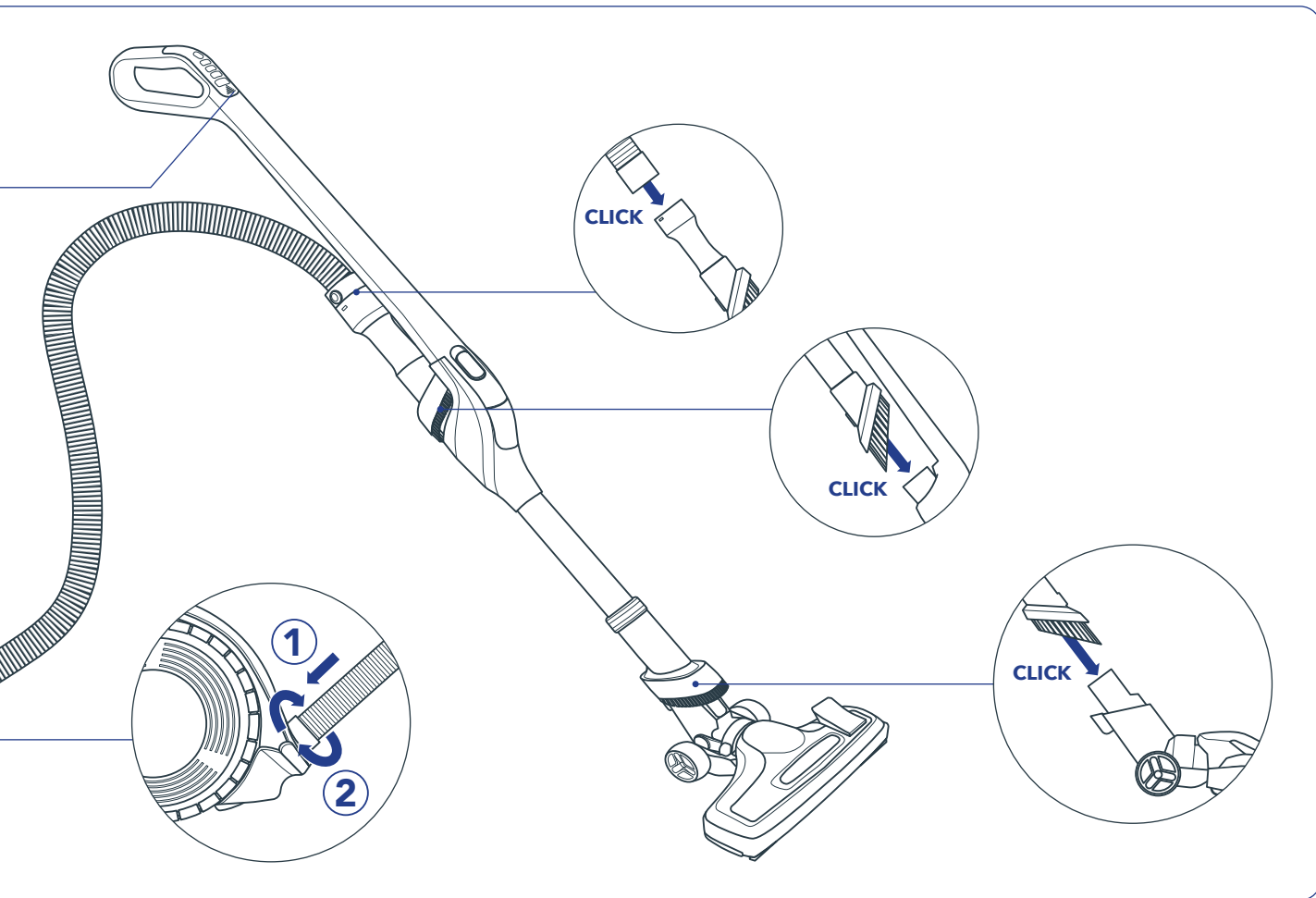

VOR DEM ERSTEN GEBRAUCH



Wie koppeln Sie die Fernbedienung?



Koppeln Sie vor dem ersten Gebrauch Ihre Fernbedienung mit dem Gerät.

Muss nur einmal durchgeführt werden.

	Das müssen Sie tun:	Was Sie auf Ihrem Gerät sehen können
1	Nehmen Sie vor dem ersten Gebrauch das Kunststoffteil ab.	
2	So schalten Sie das Gerät ein: Drücken Sie die Ein-/Aus-Taste.	Die blauen Akku-LEDs leuchten.
3.1	Kopplung starten: Drücken Sie gleichzeitig die Tasten MAX und II (Pause).	- Sie hören einen Bestätigungston - Die blauen Akku-LEDs und die grüne Geschwindigkeitsanzeige blinken abwechselnd
3.2	Kopplung bestätigen Unmittelbar nach Schritt 3.1 die Taste drücken II (während LEDs abwechselnd blinken)	- Blaue LEDs leuchten weiter - Sie hören einen doppelten Piepton. Wenn Sie nach 10 Sekunden keinen doppelten Piepton hören, ist die Kopplung fehlgeschlagen. Schalten Sie das Gerät aus und fangen Sie wieder mit Schritt 2 an.

➤ Herzlichen Glückwunsch! Sie haben Ihre Fernbedienung erfolgreich gekoppelt.

NETZSCHALTER EIN/AUS

Um das Gerät ein- und auszuschalten, halten Sie den Netzschalter kurz gedrückt. Um mit dem Staubsaugen zu beginnen, drücken Sie auf der Fernbedienung die Tasten ECO, HIGH oder MAX.

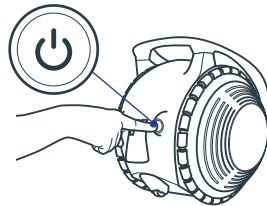

POWER-MODUS

Das Gerät verfügt über 4 Betriebsmodi für verschiedene Aufgaben. Mit der Fernbedienung können Sie den Modus wechseln und die Leistung anpassen:



BOOST: 5/10min*

Für eine intensive Reinigung bei festgetretenem Schmutz.

HINWEIS: Halten Sie die BOOST-Taste durchgehend gedrückt, um diesen Modus zu verwenden.

MAX: 20/40min*

Für eine intensive Reinigung und Staubablagerungen. Ideal für alle Teppiche.

HIGH: 40/50/90min*

Für die Grundreinigung Ideal für alle Hartböden.

ECO: 1h10/1h30/2h40min*

Für leicht verschmutzte Böden und empfindliche Oberflächen: Regale, Rahmen, Vorhänge etc.

PAUSE:

Vorübergehendes Herunterfahren während des Gebrauchs.

Die LED-Leuchten zeigen die Betriebsmodi an. Im BOOST-Modus blinken die drei grünen Leuchten gleichzeitig.

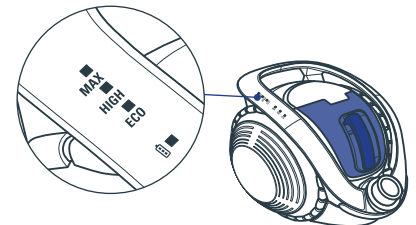

SAUGDÜSE

Die Düse an Ihrem Gerät ist sowohl für Teppich- als auch für Hartböden geeignet. Mit dem Pedalschalter können Sie zwischen den beiden Optionen wechseln.

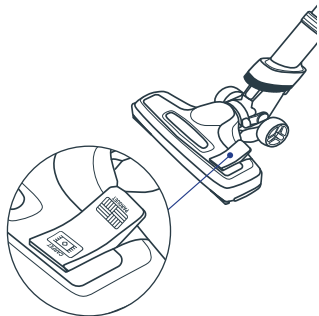

PARKETT

Hartboden-Option, kompatibel mit Holzparkett, Fliesen, Lino-
leum etc.



TEPPICHE

Teppichboden-Option, perfekt für die gründliche Reinigung von Teppichböden und Teppichen aller Art.

FERNBEDIENUNG

Das Gerät wird über eine in den Griff integrierte Fernbedienung gesteuert. Legen Sie eine Knopf-Batterie des Typs CR 2032 in die Fernbedienung ein.

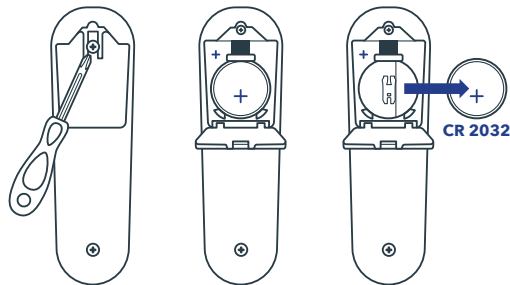

Wir empfehlen Ihnen, die Batterie alle 18 Monate auszutauschen.

Bei Verlust oder Beschädigung der Fernbedienung können Sie das Gerät weiterhin einschalten, indem Sie die EIN-Taste länger gedrückt halten

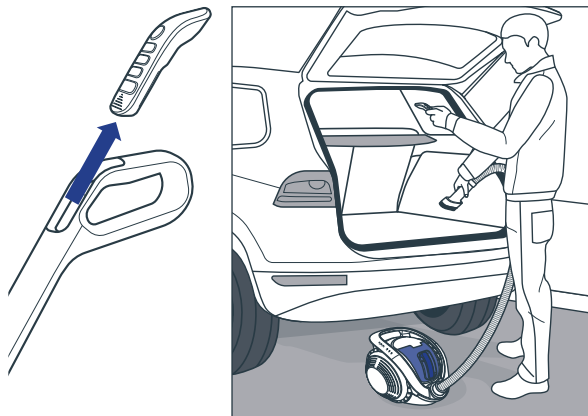

Sie können die Fernbedienung nur mithilfe des flexiblen Schlauchs abnehmen, um alle Reinigungsarbeiten, wie beispielsweise eine Autoreinigung, durchführen zu können.

Wie verwende ich die Fernbedienung?



AKKU UND LADEVORGANG



DIE DAUER EINER VOLLSTÄNDIGEN AKKULADUNG BETRÄGT VIER STUNDEN.

Sie haben zwei Optionen, um Ihr Gerät aufzuladen:

OPTION 1

Schließen Sie das Ladegerät direkt an den Staubsauger an: Schließen Sie erst die Buchse und dann den Stecker an.

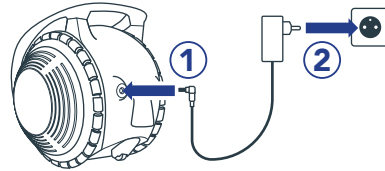

OPTION 2

Schließen Sie das Ladegerät an den Akku an. Nehmen Sie dazu den Akku aus dem Gerät, stecken Sie die Buchse ein und schließen Sie das Ladegerät an.

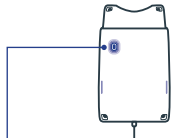
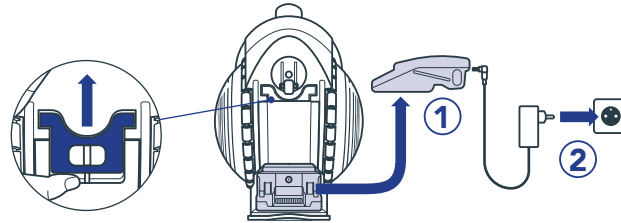

Blaue Anzeige leuchtet:
Der Akku wird aufgeladen.

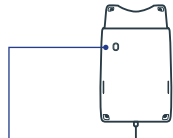

Blaues Anzeige leuchtet nicht:
Der Akku ist aufgeladen.

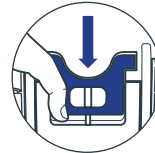
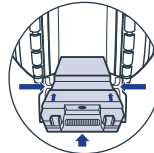

Scannen Sie den QR-Code, um mehr über den Akku und dessen Ladevorgang zu erfahren.



BATTERIEZUSTAND

Das Gerät zeigt Ihnen den Batteriezustand an:

- Drei blaue LEDs leuchten: 100% geladen.
- Zwei blaue LEDs leuchten: 60% geladen.
- Eine blaue LED-Leuchte blinkt: Gerät muss aufgeladen werden.

Wenn die Batterie komplett leer ist, blinkt eine blaue LED-Leuchte einige Male.

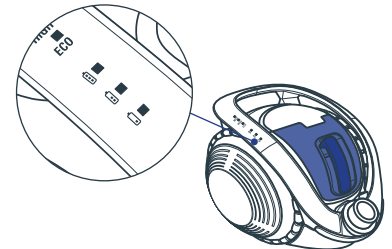

FLEX-FUNKTION

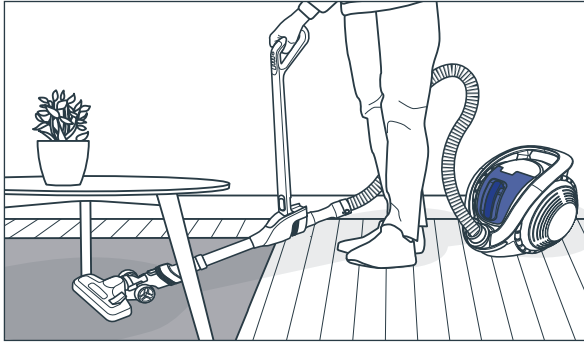

Ihr Gerät ist mit der Flex-Technologie ausgestattet. Dank dieser Technologie kann der Staubsauger auch die hintersten Stellen unter niedrigen Möbeln reinigen. Schieben Sie die Flex-Taste nach oben, um die Funktion zu aktivieren.

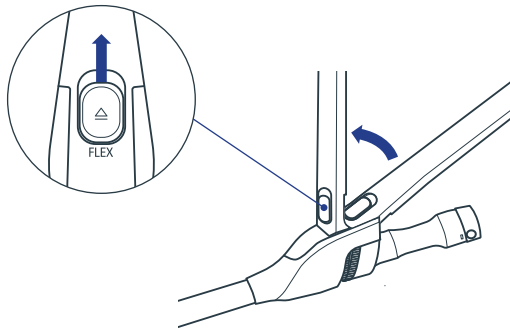

ZUBEHÖR

Ihr Gerät verfügt über zwei integrierte Bürsten zum Entstauben. Diese Bürsten können sie für die Reinigung der meisten Oberflächen verwenden.

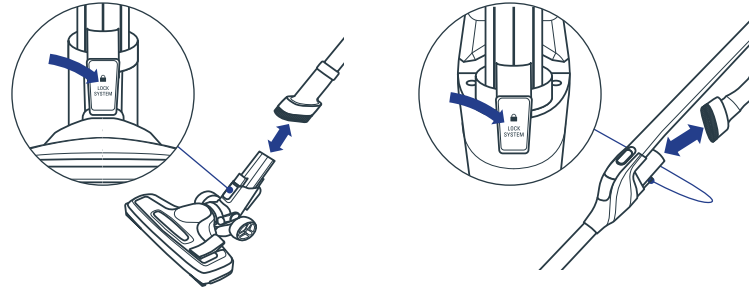

Verwenden Sie für die Reinigung bestimmter Bereiche zusätzliches Zubehör, das Sie so tief wie möglich in eines der Rohre einsetzen.

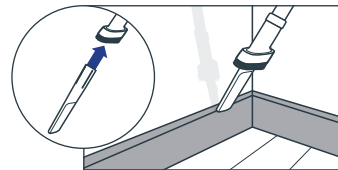

Verwenden Sie **die Fugendüse**, um schwer erreichbare Stellen zu reinigen.

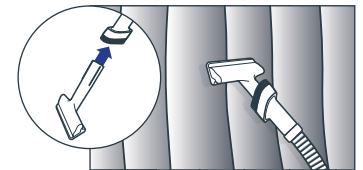

Verwenden Sie **die Sofabürste**, um Textilien wie Sofas, Vorhänge oder Matratzen zu reinigen.

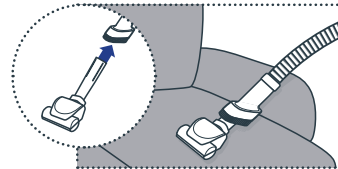

Verwenden Sie die **Mini-Turbo-Bürste im MAX- oder BOOST-Modus für eine Tiefenreinigung Ihrer Sofas, Matratzen, Teppiche oder Automatten.

**Nur bei bestimmten Modellen verfügbar.



WAR- TUNG

Scannen Sie den QR-Code mit Ihrem Smartphone oder einem QR-Reader, um bestmöglich von den Wartungshinweisen für die beste Leistung zu profitieren.



ENTLEEREN DES STAUBBEHÄLTERS

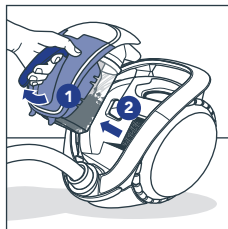
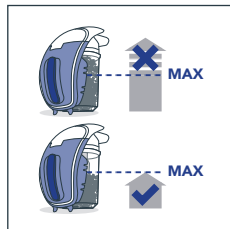

WARTUNG DES ZYKLONFILTERS

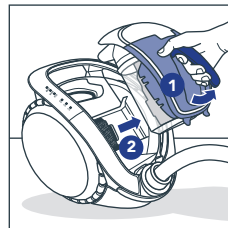
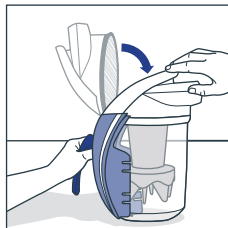
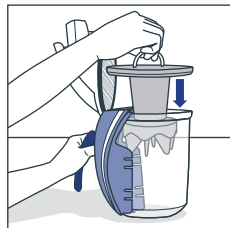
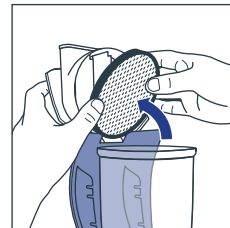
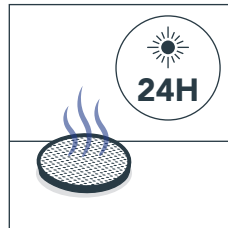
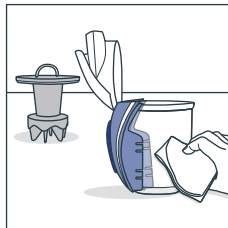
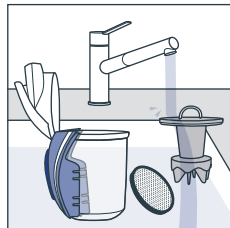

Waschen Sie den Zyklonfilter nach jedem Leeren des Staubbehälters mit Wasser. Tauschen Sie ihn einmal pro Jahr aus. Suchen Sie nach Rowenta ZR007700, um einen neuen Filter zu kaufen.

WARTUNG DES MOTORFILTERS



1X
MONATLICH

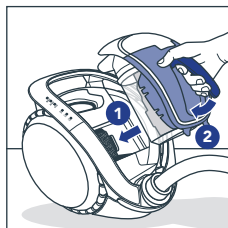
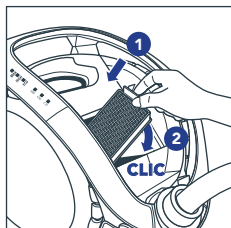
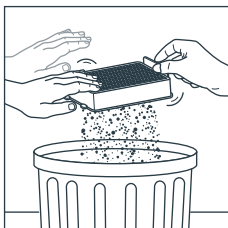
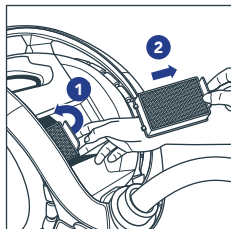
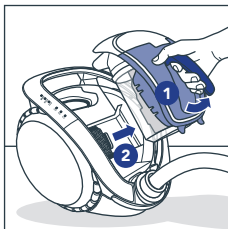

1X
JÄHRLICH

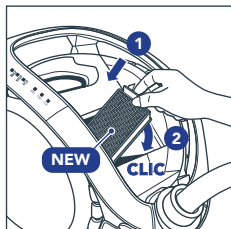
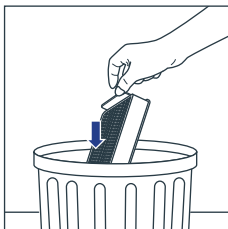

Tauschen Sie den Motorfilter einmal im Jahr aus.

Suchen Sie nach Rowenta ZR007700, um einen neuen Filter zu kaufen.

REINIGUNG DER MINI-TURBO-BÜRSTE

Nehmen Sie die Mini-Turbo-Bürste vor der Reinigung immer ab (nur bei bestimmten Modellen verfügbar).

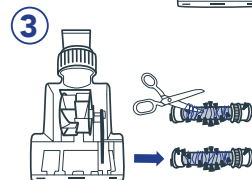
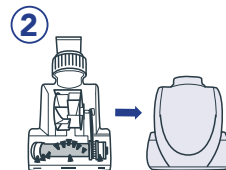

AUFBEWAHRUNG

OPTION 1

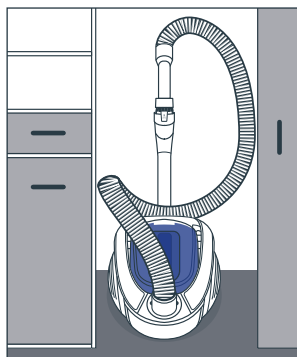
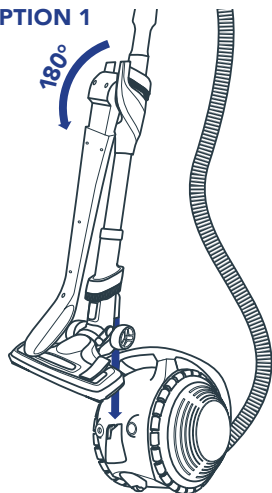

OPTION 2

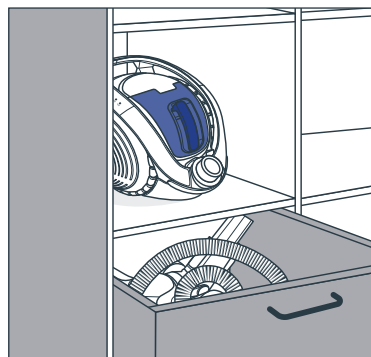
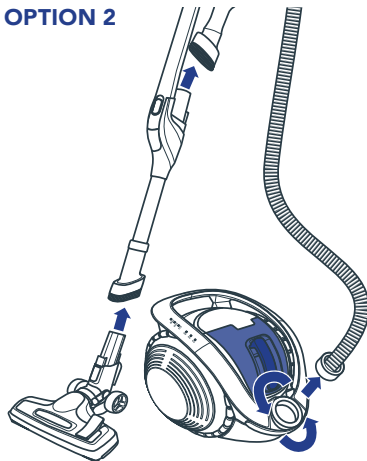

VORSICHT

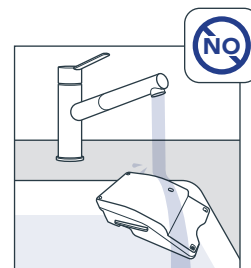

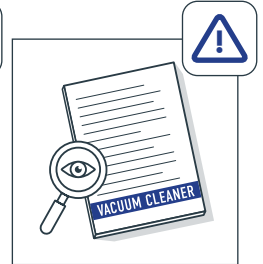
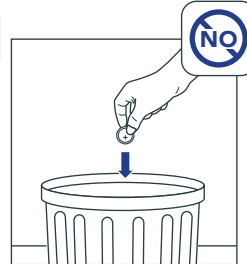
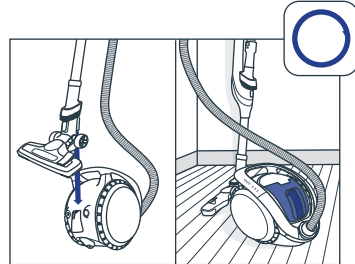
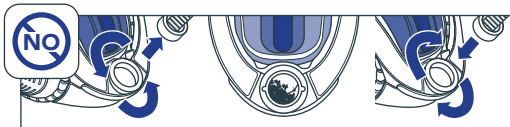
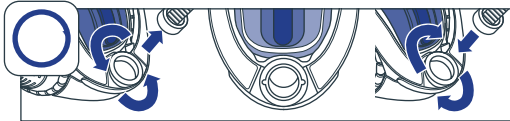
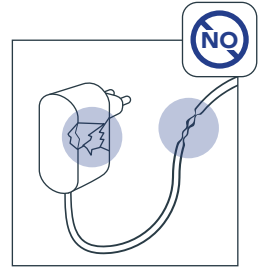
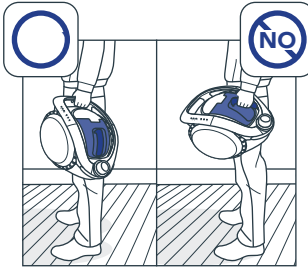
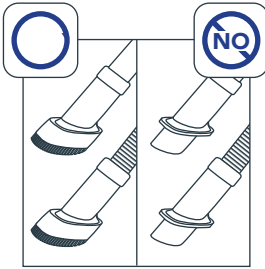
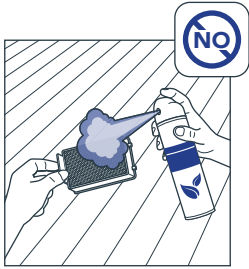
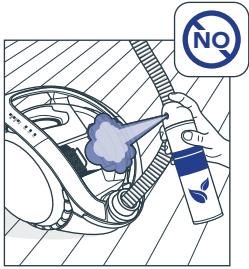
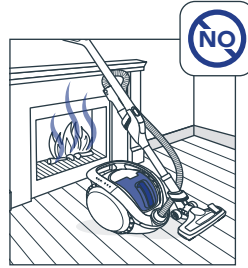
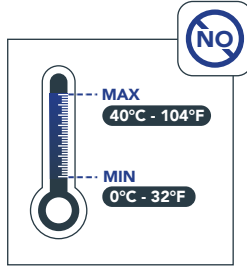



Bedankt voor uw aankoop van de Rowenta X-Ö.

Uw apparaat is uitgerust met de nieuwste Rowenta-technologieën.

Lees deze gebruiksaanwijzing zorgvuldig door om het maximale resultaat uit uw apparaat te halen.

U kunt de video met handige montage tips bekijken door de code met uw telefooncamera of QR-lezer te scannen.



MONTEREN



Waarschuwing!
Een actie die moet worden ondernomen vóór de eerste ingebruikname.
Zie pagina 26.

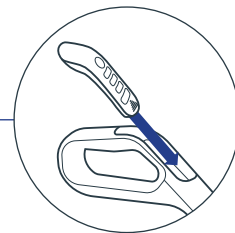
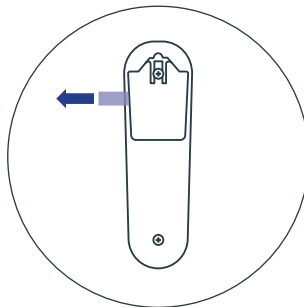

HET APPARAAT MOET VOLLEDIG ZIJN OPGELADEN VOORDAT U DEZE DE EERSTE KEER GEBRUIKT

Sluit de jackplug eerst aan voordat u de stekker in het stopcontact steekt.

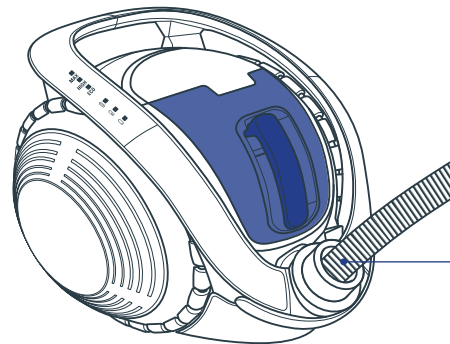
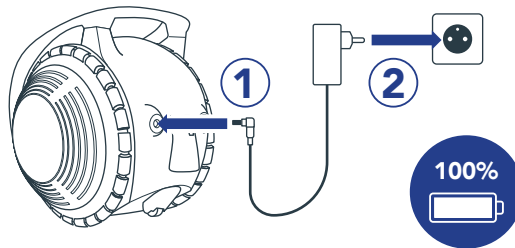

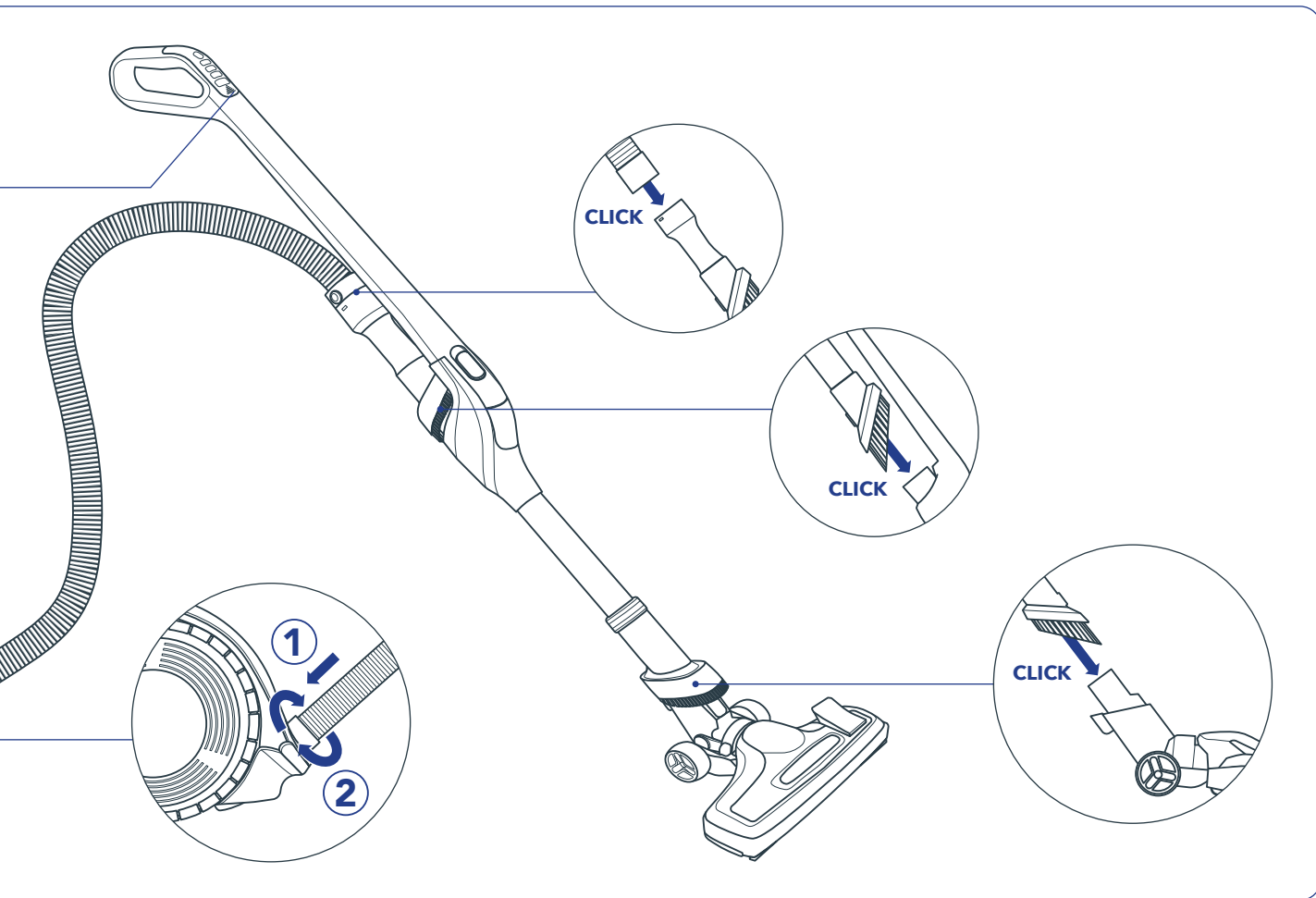

VÓÓR EERSTE INGEBRIJKNAME



Hoe koppel ik mijn afstandsbediening?



Koppel de afstandsbediening vóór het eerste gebruik.

Hoeft slechts een keer te worden gedaan.

	Wat u moet doen:	Wat u ziet op het apparaat:
1	Verwijder het plastic lipje vóór het eerste gebruik.	
2	Het apparaat inschakelen. Druk op de aan/uit-knop	De blauwe ledlampjes voor de batterij lichten op.
3.1	Koppeling starten: Druk tegelijkertijd op de MAX - en II (pauze)-knop.	- U hoort een bevestigingstoon - De blauwe ledlampjes voor de batterij en groene snelheidsindicatielampjes knipperen afwisselend
3.2	Bevestig de koppeling Druk onmiddellijk na stap 3.1 op de knop II . (terwijl de lampjes afwisselend knipperen)	- De blauwe ledlampjes blijven branden. - U hoort een dubbele pieptoon. Het apparaat is niet gekoppeld als u na tien seconden geen dubbele pieptoon hoort. Schakel het apparaat uit en start het opnieuw vanaf stap 2.
<p>> Gefeliciteerd! U hebt de afstandsbediening gekoppeld.</p>		

AAN/UIT-KNOP

Als u het apparaat wilt in- en uitschakelen, drukt u kort op de aan-uitknop.

Druk op de knop ECO, HIGH (Hoog) of MAX op de afstandsbediening om te beginnen met stofzuigen.

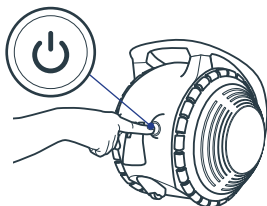

STANDEN

Het apparaat heeft 4 standen voor verschillende taken. U kunt schakelen tussen de schoonmaakstanden met de knoppen op de afstandsbediening om de kracht aan te passen:

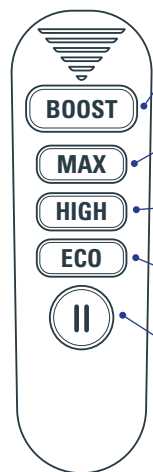

BOOST: 5/10min*

Intensieve reiniging voor ingetrokken vuil.

NB: Houd de BOOST-knop ingedrukt om deze modus te gebruiken.

MAX: 20/40min*

Intensieve reiniging en hardnekkig stof. Ideaal voor alle soorten tapijten.

HIGH (Hoog): 40/50/90min*

Voor onderhoudsreiniging. Ideaal voor alle soorten harde vloeren.

ECO: 1h10/1h30/2h40min*

Voor licht bevulde vloeren en kwetsbare oppervlakken: planken, lijstjes, gordijnen, enz.

PAUSE (Onderbreken):

Het apparaat tijdelijk uitschakelen tijdens gebruik.

De LEDLAMPJES geven de stand aan. In de BOOST-modus knipperen alle drie de groene lampjes tegelijk.

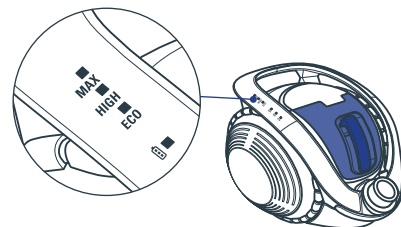

*afhankelijk van het model.

ZUIGMOND

De zuigmond heeft 2 standen en een pedaalschakelaar, waarmee u kunt schakelen tussen de stand voor tapijten of harde vloeren.

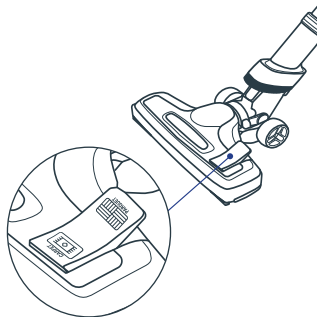

PARKETVLOER

Zuigstand voor harde vloeren, geschikt voor houten parketvloeren, tegels, linoleum, enz.



TAPIJT

Zuigstand voor tapijt, ideaal om vloerkleden of tapijt grondig te reinigen.

AFSTANDSBEDIENING

U bedient het apparaat door middel van een in het handvat geïntegreerde afstandsbediening. Werkt op een ronde batterij van het type CR2032.

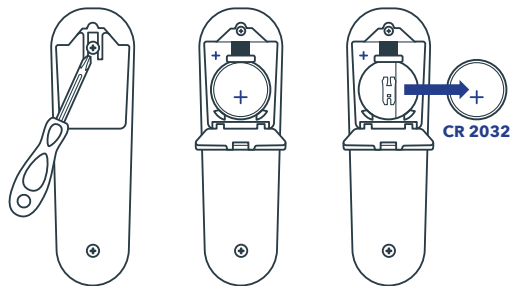

We raden u aan de batterij elke 18 maanden te vervangen.

Mocht u de afstandsbediening kwijt raken of mocht deze beschadigd raken, dan kunt u het apparaat nog steeds inschakelen door de AAN-knop lang ingedrukt te houden.

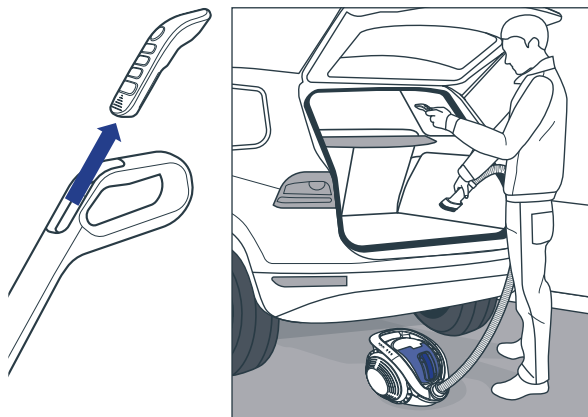

U kunt de afstandsbediening loskoppelen om alleen de flexibele slang te gebruiken (bijvoorbeeld bij het reinigen van uw auto).

Hoe gebruik ik mijn afstandsbediening?



BATTERIJ EN OPLADEN



HET DUURT 4 UUR OM DE BATTERIJ VOLLEDIG OP TE LADEN.

U kunt het apparaat op twee manieren opladen:

OPTIE 1

Sluit de lader rechtstreeks aan op de stofzuiger: sluit de jackplug eerst aan op het apparaat voordat u de stekker in het stopcontact steekt.

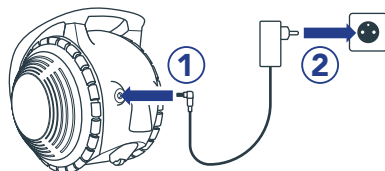

OPTIE 2

Sluit de lader aan op de batterij. Voor deze manier haalt u de batterij uit het apparaat, sluit u de jackplug aan op de batterij en steekt u vervolgens de stekker in het stopcontact.

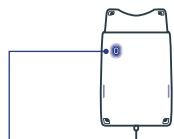
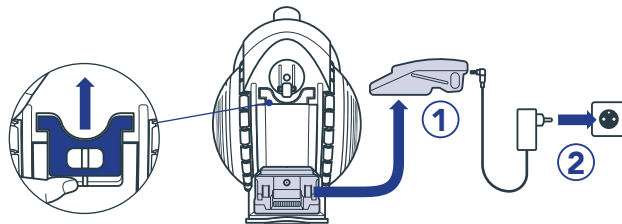

Blauw lampje is aan:
de batterij wordt
opgeladen.

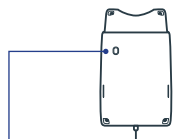

Blauw lampje is uit:
de batterij is opgeladen.

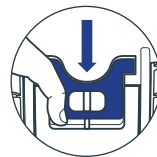
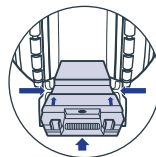

Scan voor meer informatie
over de batterij en het
opladen.



BATTERIJSTATUS

Het apparaat geeft het oplaadniveau van de batterij aan:

- 3 blauwe LEDLAMPJES branden: 100% opgeladen.
- 2 blauwe LEDLAMPJES branden: 60% opgeladen.
- 1 blauw LEDLAMPJE knippert: het apparaat moet worden opgeladen.

Als de batterij helemaal leeg is, knippert 1 blauw LEDLAMPJE enkele keren.

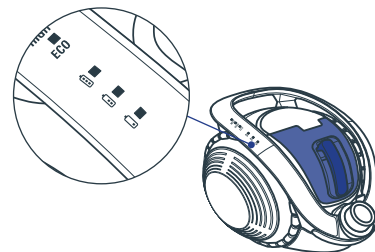

FLEX-FUNCTIE

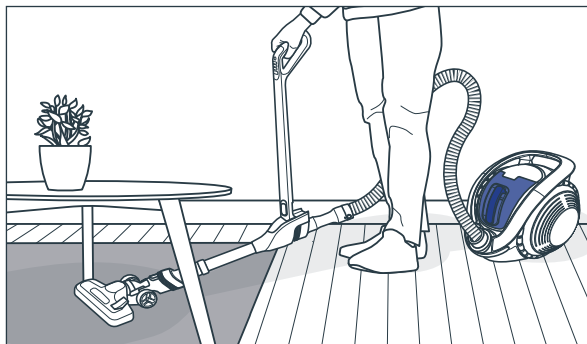

Het apparaat is uitgerust met Flex-technologie. Met deze functie kunt u moeiteloos ver onder lage meubels stofzuigen. Schuif de Flex-knop omhoog om de functie in te schakelen.

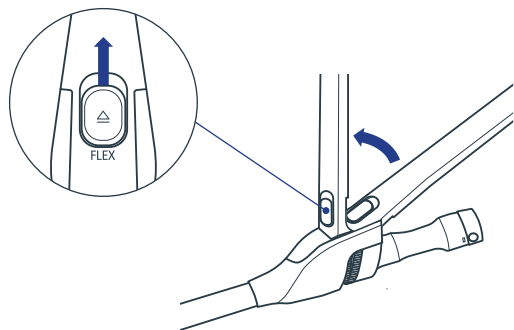

ACCESSOIRES

Het apparaat bevat 2 ingebouwde Easy Dusting-borstels. Deze kunt u gebruiken om de meeste oppervlakken te stofzuigen.

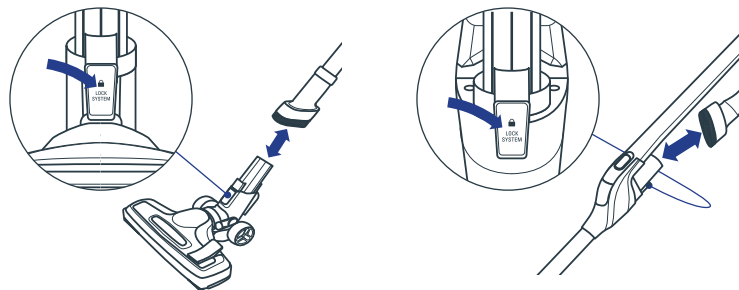

Voor het stofzuigen van specifieke plekken gebruikt u aanvullende accessoires. Steek deze zo diep mogelijk in een van de buizen.

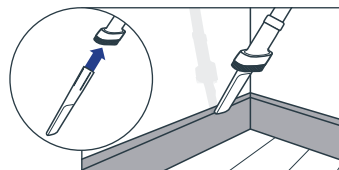

Gebruik **de kierenzuigmond** om op moeilijk bereikbare plekken te stofzuigen.

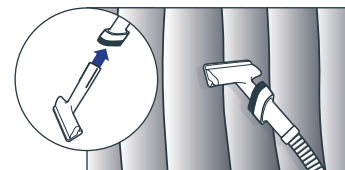

Gebruik **de meubelzuigmond** om textiel zoals uw bankstel, gordijnen of matras te stofzuigen.

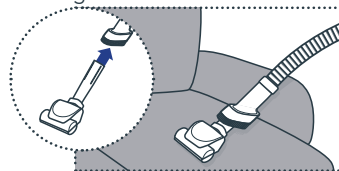

Gebruik **de mini-turboborstel in de MAX- of BOOST-modus om uw bankstel, matras of automat grondig te stofzuigen.



ONDERHOUD

Scan met uw telefoon of QR-lezer om optimaal te profiteren van onderhoudsadvies voor de beste prestaties.



HET STOFRESERVOIR LEGEN

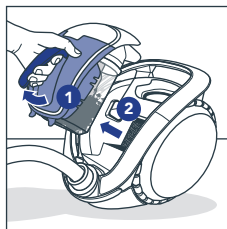
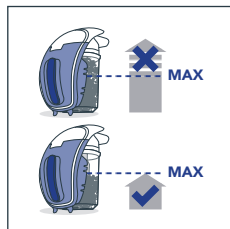

ONDERHOUD VAN HET CYCLOONFILTER

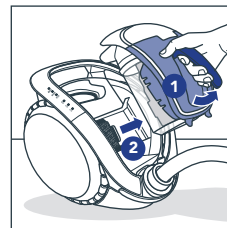
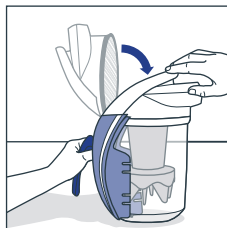
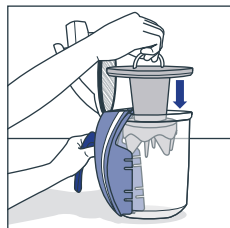
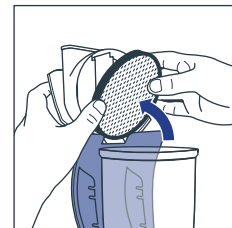
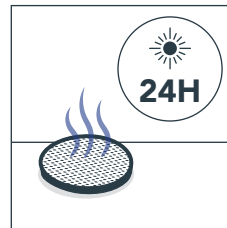
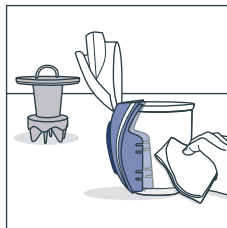
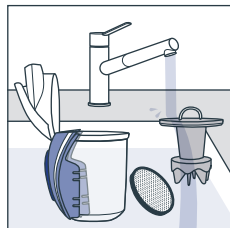

Reinig het cycloonfilter met water telkens wanneer u de stofvangbak leegt. Vervang het eens per jaar. Indien u van plan bent een nieuw cycloonfilter te kopen, zoekt u ter referentie op Rowenta ZR007700.

ONDERHOUD VAN HET MOTORFILTER



1 KEER
PER MAAND

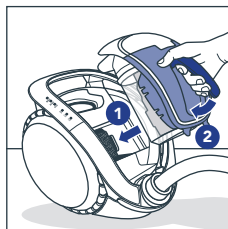
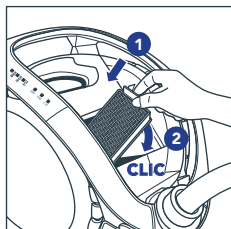
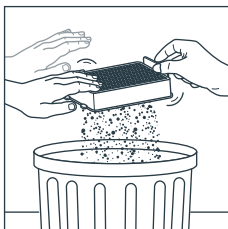
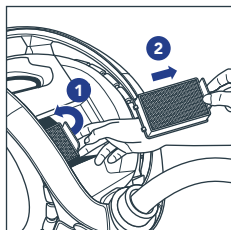
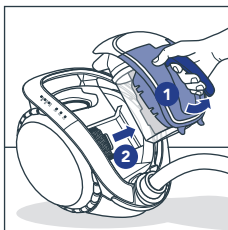

1 KEER
PER JAAR

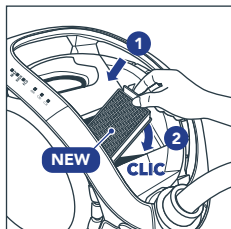
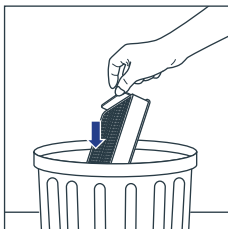

Vervang het motorfilter één keer per jaar.

Indien u van plan bent een nieuw motorfilter te kopen, zoekt u ter referentie op Rowenta ZR007700.

DE MINI-TURBOBORSTEL REINIGEN

Haal altijd de mini-turboborstel van de stofzuiger af voordat u deze reinigt (alleen beschikbaar voor bepaalde modellen).

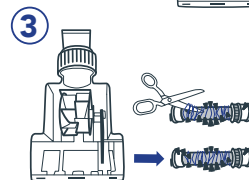
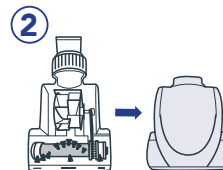

OPBERGEN

OPTIE 1

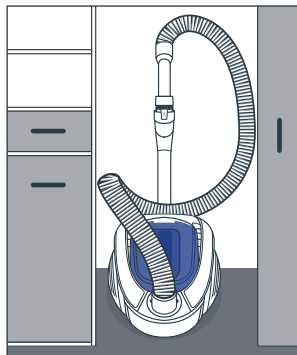
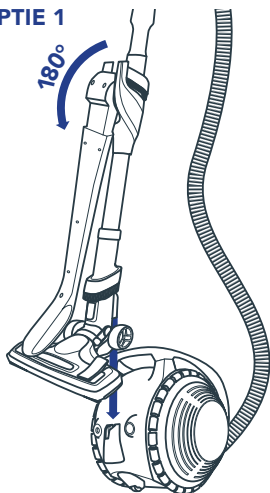

OPTIE 2

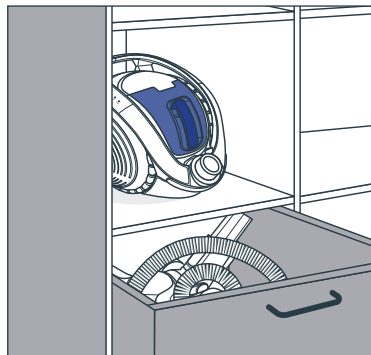
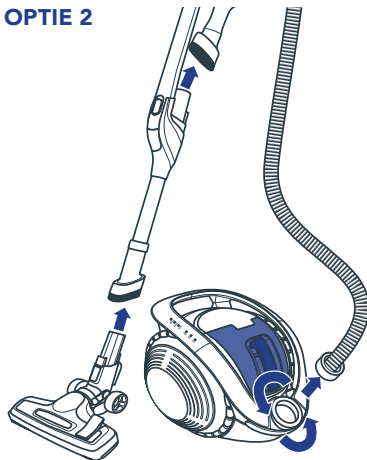

LET OP

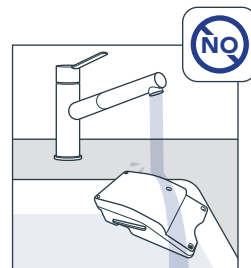
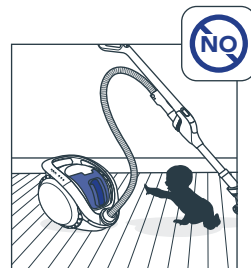

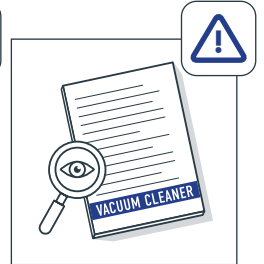
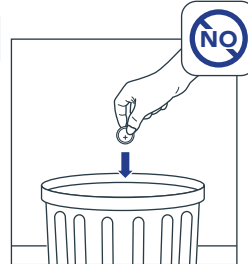
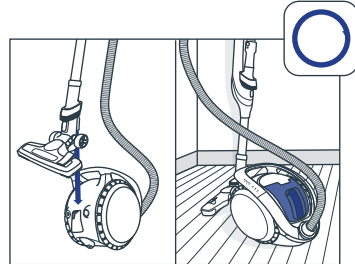
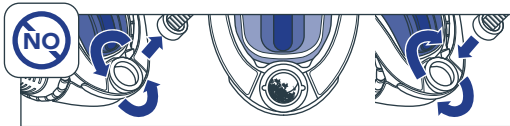
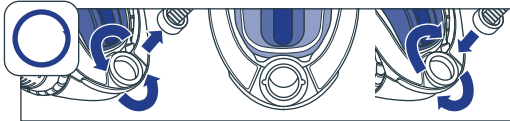
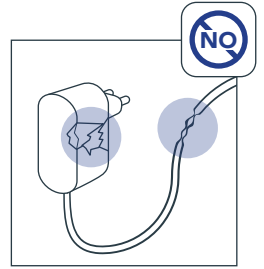
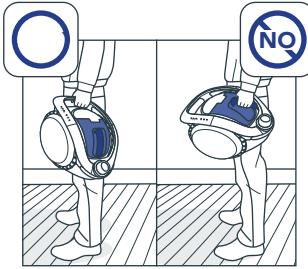
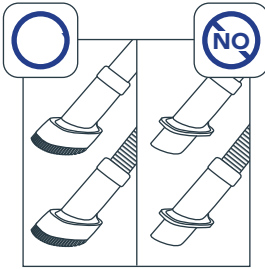
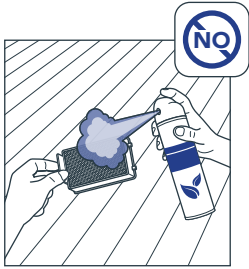
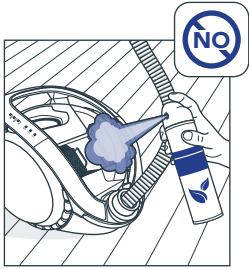
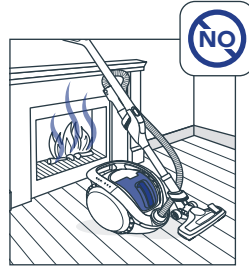
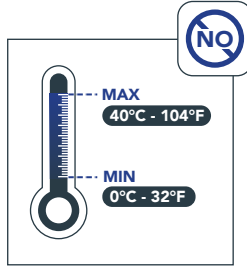



Grazie per aver scelto di acquistare un Rowenta X-Ö.

L'apparecchio è dotato delle ultime tecnologie Rowenta.

Leggere attentamente questo manuale per sfruttare al meglio le potenzialità dell'apparecchio.

Esegui la scansione con il tuo cellulare o il lettore QR e guarda il video-guida per assemblare l'apparecchio



ASSEMBLAGGIO



Avvertenza!
Operazione da eseguire prima del primo utilizzo vedere pagina 36.

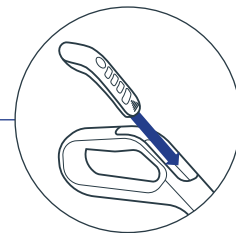
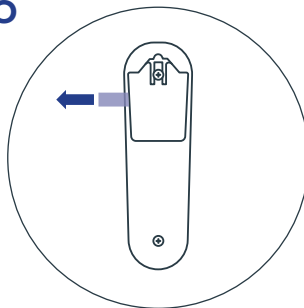

L'APPARECCHIO DEVE ESSERE COMPLETAMENTE CARICO PRIMA DEL PRIMO UTILIZZO.

Collegare la presa prima dell'accensione.

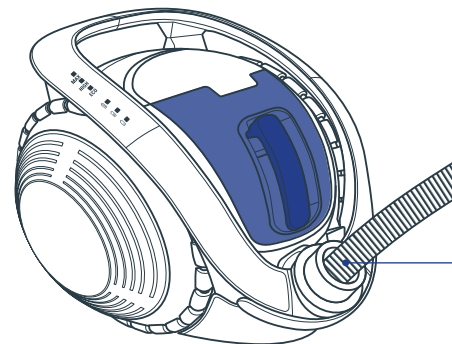
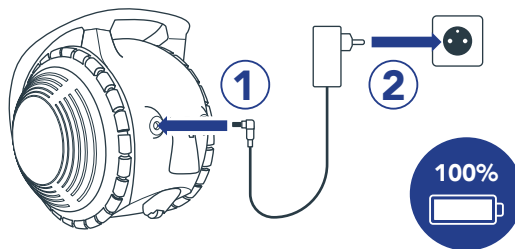

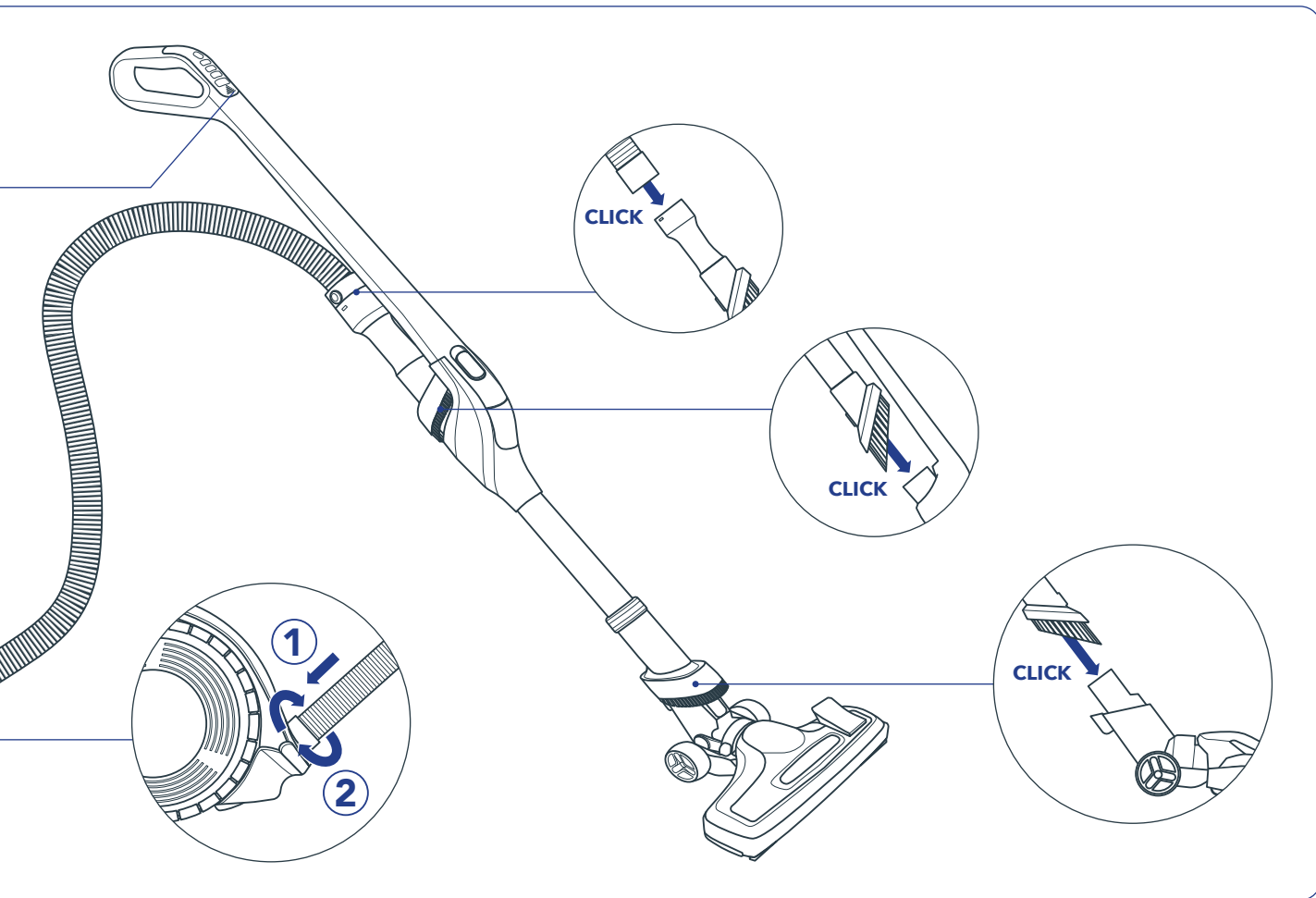

PRIMA DEL PRIMO UTILIZZO



Come associare il mio telecomando?



Associare il telecomando prima del primo utilizzo.

Questa operazione deve essere eseguita una sola volta.

	Cosa fare:	Cosa si può vedere sull'apparecchio
1	Togliere la linguetta di plastica prima del primo utilizzo.	
2	Per accendere l'apparecchio: Premere il pulsante di accensione/spengimento.	I LED blu della batteria si illuminano.
3.1	Avviare l'associazione: Premere contemporaneamente i pulsanti MAX e II (pausa).	- Viene emesso un segnale acustico di conferma - I LED blu della batteria e gli indicatori di velocità verdi lampeggiano alternativamente
3.2	Confermare l'associazione: Premere il pulsante PAUSA subito dopo il punto 3.1 II (mentre i LED lampeggiano alternativamente)	- I LED blu mantengono l'illuminazione - Viene emesso un doppio segnale acustico Se dopo 10 secondi non viene emesso un doppio segnale acustico l'associazione non è riuscita. Spegnerne l'apparecchio e tornare al punto 2.

> **Congratulazioni! Il telecomando è stato associato correttamente.**

PULSANTE DI ACCENSIONE ON/OFF

Per accendere e spegnere l'apparecchio, premere brevemente il pulsante di accensione.

Per avviare l'aspirazione, selezionare una delle modalità di velocità ECO, ALTA o MAX sul telecomando.

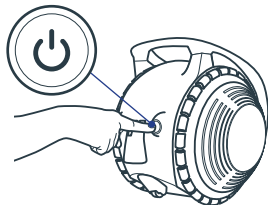

MODALITÀ DI ASPIRAZIONE

L'apparecchio dispone di 4 modalità di aspirazione per diverse esigenze di pulizia. Modificare le modalità di pulizia utilizzando i pulsanti del telecomando e scegliere l'aspirazione:

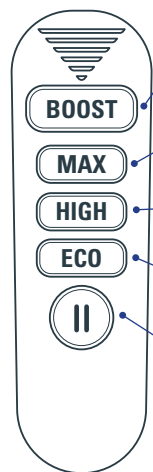

BOOST: 5/10min*

Pulizia intensiva per pavimento sporco.

NB: continuare a premere il pulsante BOOST per utilizzare questa modalità.

MAX: 20/40min*

Pulizia intensiva e polvere abbondante. Ideale su tutti i tipi di moquette.

HIGH (Alta): 40/50/90min*

Pulizia di mantenimento. Ideale per tutti i tipi di pavimenti duri.

ECO: 1h10/1h30/2h40min*

Pavimenti con sporco leggero e superfici delicate: ripiani, cornici, tende ecc.

PAUSA:

Spegnimento temporaneo durante l'uso.

I LED indicano le modalità di aspirazione.

In modalità BOOST, tutte e tre le spie verdi lampeggiano contemporaneamente.

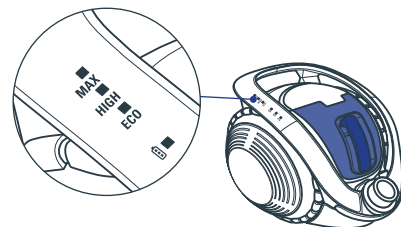

*a seconda del modello.

SPAZZOLA DI ASPIRAZIONE

La spazzola a 2 posizioni è dotata di un interruttore a pedale che consente di passare dalla posizione per i tappeti e moquette alla posizione per i pavimenti duri.

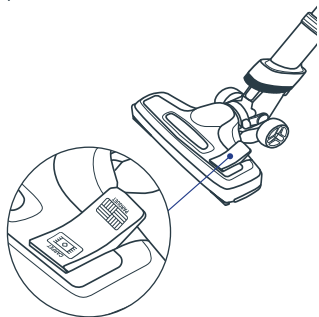

PARQUET

Pavimento duro, compatibile con parquet, piastrelle, linoleum ecc.



TAPPETO

Perfetta per aspirare in profondità qualsiasi moquette o tappeto.

TELECOMANDO

L'apparecchio è controllato da un telecomando integrato nell'impugnatura. È alimentato da una batteria rotonda tipo CR2032.

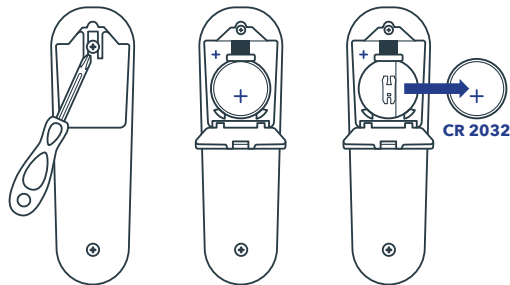

Si consiglia di sostituirla ogni 18 mesi.

In caso di perdita o danneggiamento del telecomando, è comunque possibile accendere l'apparecchio premendo il pulsante ON a lungo.

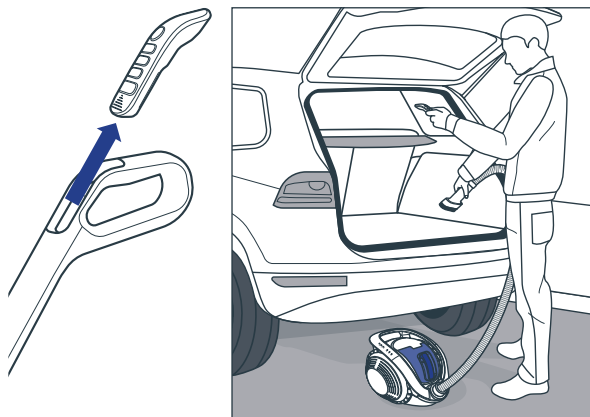

È possibile scollegare il telecomando per eseguire tutte le sessioni di pulizia solo con il tubo flessibile (ideale per la pulizia dell'auto, ad esempio).

Come utilizzare il telecomando?



BATTERIA E CARICA



LA CARICA COMPLETA DELLA BATTERIA RICHIEDE 4 ORE.

Per caricare l'apparecchio, è possibile scegliere tra due opzioni:

OPZIONE 1

Collegare il caricabatteria direttamente all'aspirapolvere: inserire prima la presa, quindi collegare.

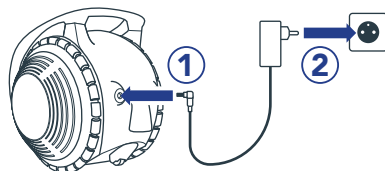

OPZIONE 2

Collegare il caricabatteria alla batteria. A tale scopo, rimuovere la batteria dall'apparecchio, inserire la presa e collegare il caricabatteria.

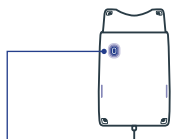
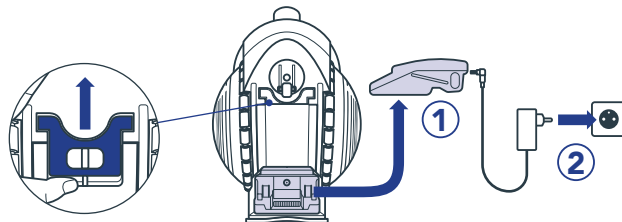

Spia blu accesa:
la batteria è in carica.

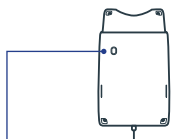

Spia blu spenta:
la batteria è carica.

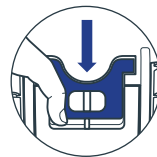
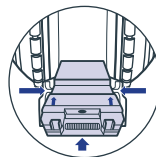

Eseguire la scansione per ulteriori informazioni sulla batteria e sulla relativa ricarica.



STATO DELLA BATTERIA

L'apparecchio indica il livello di carica:

- 3 LED blu: 100% di carica.

- 2 LED blu: 60% di carica.

- 1 LED blu lampeggiante: L'apparecchio deve essere ricaricato.

Se la batteria è completamente scarica, 1 LED blu lampeggia più volte.

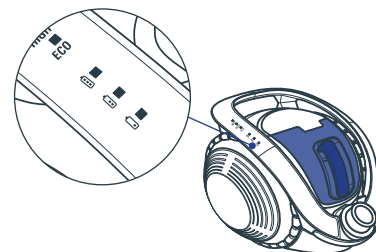

FUNZIONE FLEX

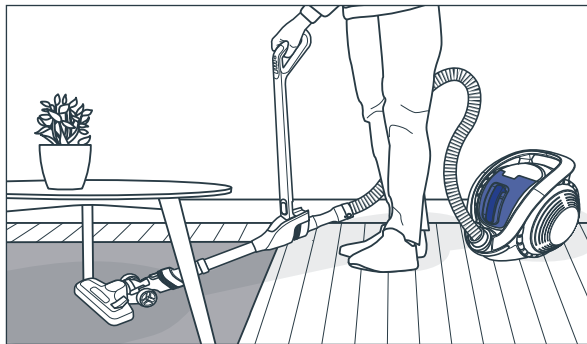

L'apparecchio è dotato di tecnologia Flex. Consente di raggiungere facilmente i punti più lontani, anche sotto ai mobili di altezza ridotta.

Per attivarlo, far scorrere il pulsante Flex verso l'alto.

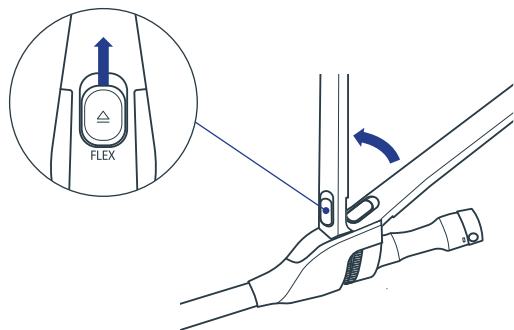

ACCESSORI

L'apparecchio è dotato di 2 spazzole Easy Dusting integrate. È possibile utilizzarle per aspirare la maggior parte delle superfici, anche quelle delicate.

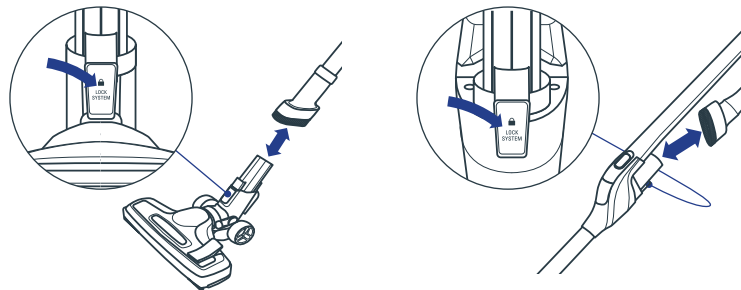

Per la pulizia di aree specifiche, utilizzare accessori aggiuntivi: inserirli in uno dei tubi alla massima profondità.

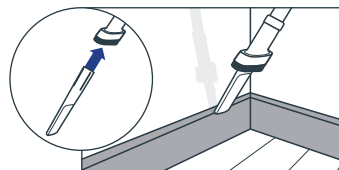

Utilizzare **la bocchetta a lancia** per aspirare i punti difficili da raggiungere.

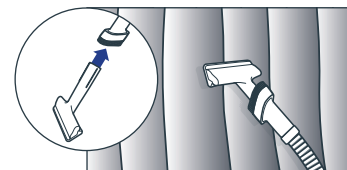

Utilizzare **la spazzola per il divano** per aspirare tessuti come divani, tende o materassi.

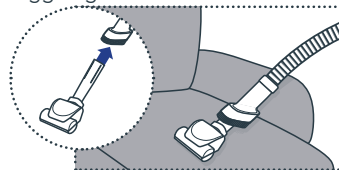

Utilizzare la **spazzola mini turbo scegliendo la modalità MAX o BOOST per aspirare a fondo su divani, materassi o tappetini auto.

***disponibile solo su alcuni modelli.*

X-Ö

MANUTENZIONE

Eseguire la scansione con il telefono o il lettore QR per seguire al meglio i consigli di manutenzione e ottenere le prestazioni migliori.



SVUOTAMENTO DEL CONTENITORE DELLA POLVERE

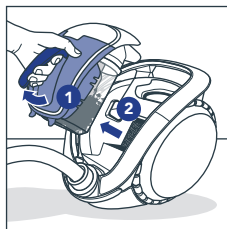
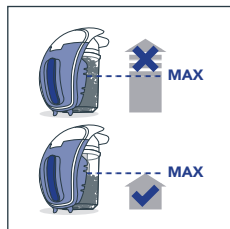

MANUTENZIONE DEL FILTRO A CICLONE

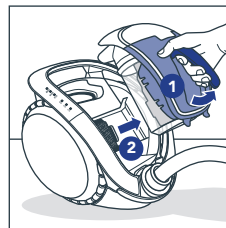
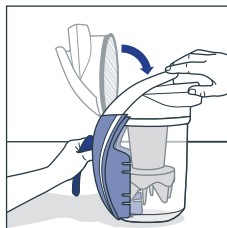
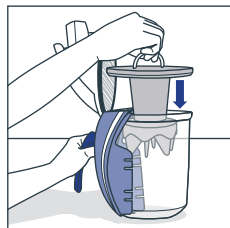
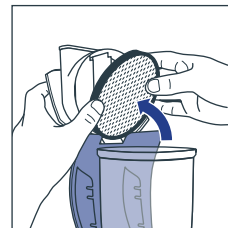
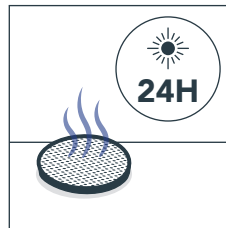
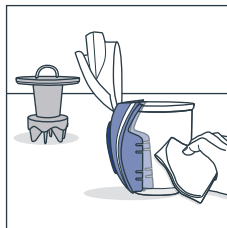
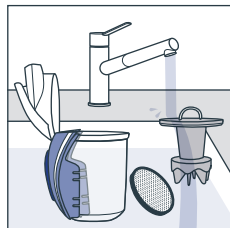

Lavare il filtro ciclonico con acqua dopo ogni svuotamento del contenitore della polvere. Sostituirlo una volta all'anno. Per acquistarne uno nuovo, cercare il riferimento Rowenta ZR007700.

MANUTENZIONE DEL FILTRO DEL MOTORE



1 VOLTA
AL MESE

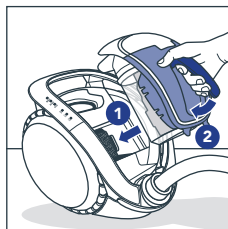
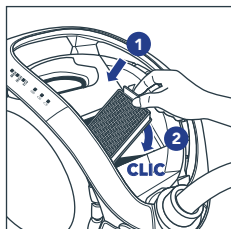
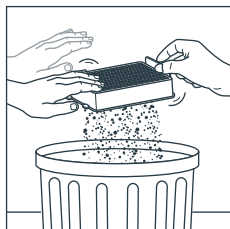
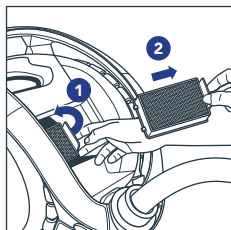
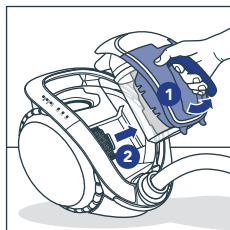

1 VOLTA
ALL'ANNO

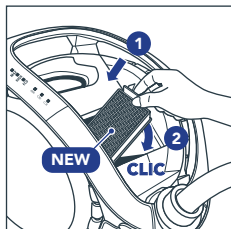
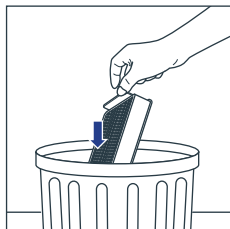

Sostituire il filtro del motore una volta all'anno.

Per acquistarne uno nuovo, cercare il riferimento Rowenta ZR007700.

PULIZIA DELLA SPAZZOLA MINI TURBO

Rimuovere sempre l'accessorio spazzola mini-turbo prima della pulizia (disponibile su alcuni modelli).

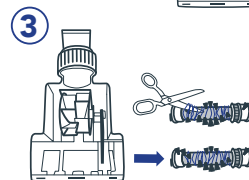
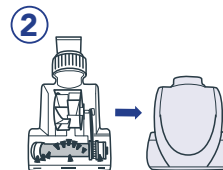

CONSERVAZIONE

OPZIONE 1

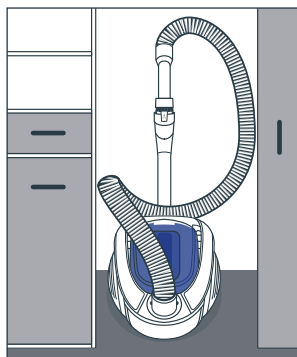
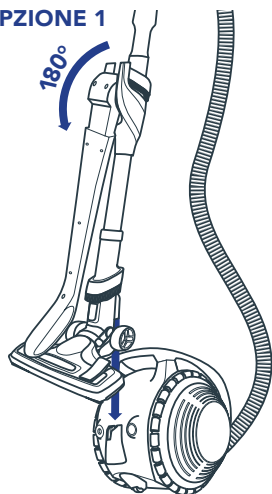

OPZIONE 2

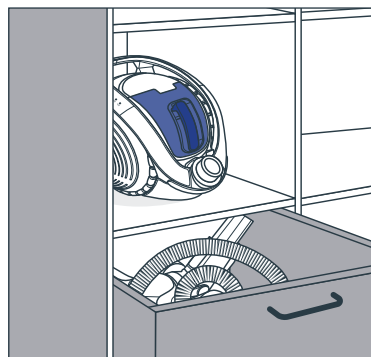
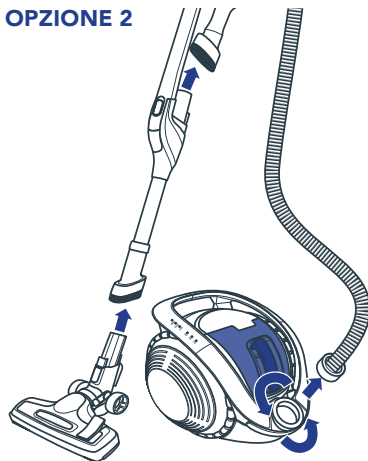

ATTENZIONE

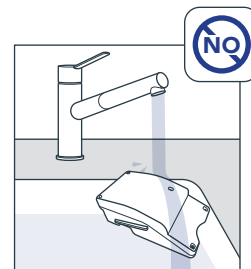

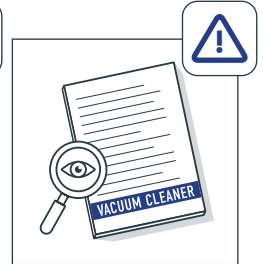
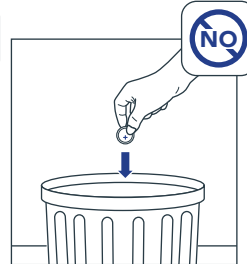
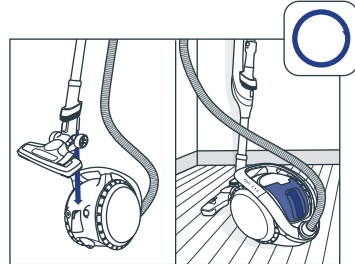
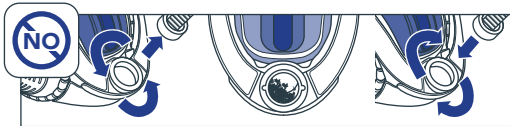
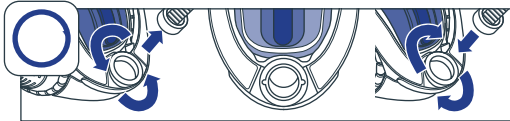
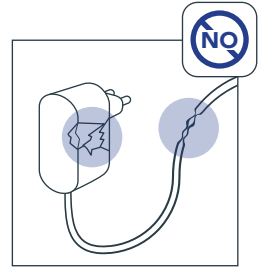
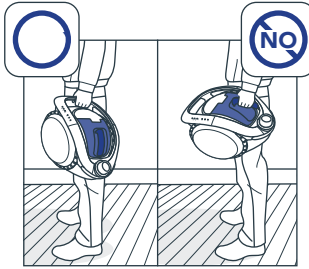
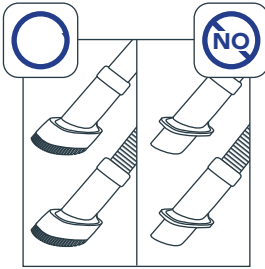
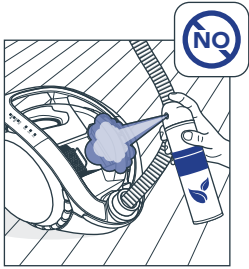
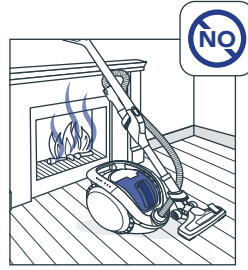
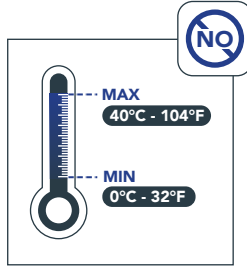



Gracias por comprar una Rowenta X-Ö.

El aparato está equipado con las últimas tecnologías de Rowenta.

Lee atentamente este manual para sacar el máximo partido a la capacidad del aparato.

Escanea con la cámara de tu móvil o con algún lector de códigos QR para ver el vídeo de ayuda sobre cómo montar el aparato



MONTAJE



Advertencia!
Consulta la página 46 para saber qué debes hacer antes de la primera utilización.

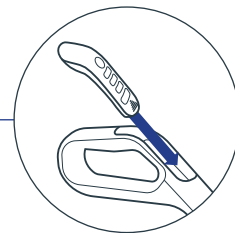
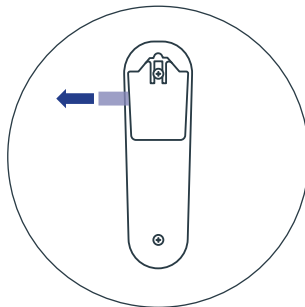

EL APARATO DEBE ESTAR COMPLETAMENTE CARGADO ANTES DE LA PRIMERA UTILIZACIÓN

Conecta la toma antes de enchufar el aparato.

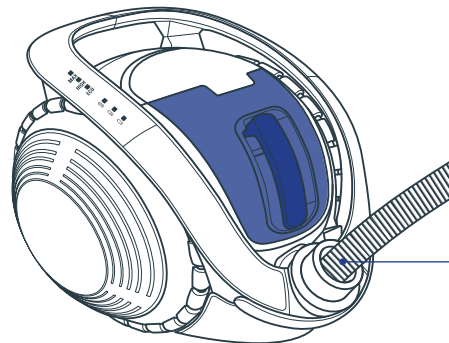
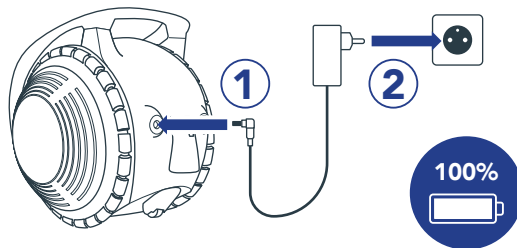

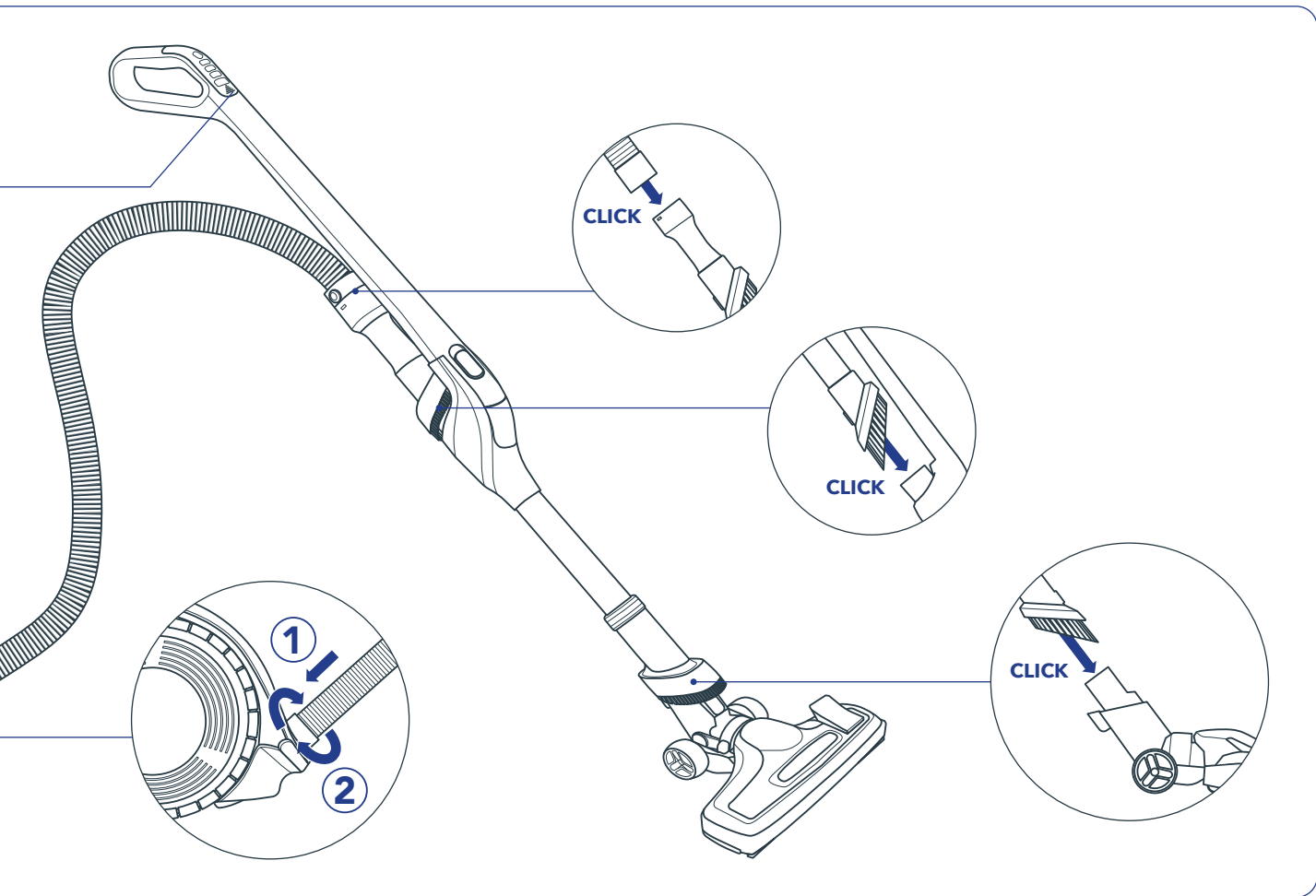

ANTES DE LA PRIMERA UTILIZACIÓN



¿Cómo emparejar el mando a distancia?



Empareja el mando a distancia antes de utilizarlo por primera vez.

Hacer solo una vez.

	Qué tienes que hacer:	Lo que se ve en el producto
1	Extrae la pestaña de plástico antes del primer uso.	
2	Para encender el aparato: Pulsa el botón de encendido/apagado.	Los LED azules de la batería se iluminan.
3.1	Inicia el emparejamiento: Pulsa a la vez los botones MAX y II (pausa).	- Oírás un pitido de confirmación. - Los LED azules de la batería y los LED verdes de los indicadores de velocidad empezarán a parpadear alternativamente.
3.2	Confirma que el emparejamiento ha sido correcto. Pulsa el botón de encendido inmediatamente después del paso 3.1 II . (mientras los LED parpadean alternativamente).	- Los LED azules seguirán iluminados. - Oírás un pitido doble. Si no has escuchado el pitido doble en un margen de 10 segundos: el emparejamiento ha fallado. Apaga el aparato y vuelve a empezar desde el paso 2.

➤ ¡Enhorabuena! Has emparejado correctamente el mando a distancia.

BOTÓN DE ENCENDIDO/APAGADO

Para encender y apagar el aparato, pulsa brevemente el botón de encendido.

Para empezar a aspirar, pulsa en las velocidades ECO, HIGH o MAX del mando a distancia.

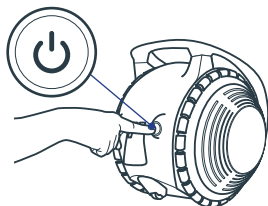

MODO DE POTENCIA

El aparato dispone de 4 modos de potencia para diferentes tareas. Cambia los modos de limpieza con los botones del mando a distancia y ajusta la potencia:

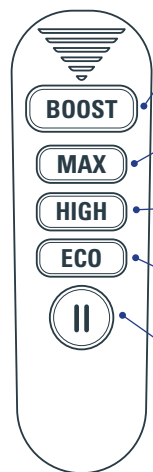

BOOST: 5/10min*

Limpieza intensiva para la suciedad incrustada.
NOTA: Mantén pulsado el botón **BOOST** para utilizar este modo.

MAX: 20/40min*

Limpieza intensiva y polvo incrustado. Ideal para todo tipo de alfombras.

HIGH: 40/50/90min*

Para limpieza de mantenimiento. Ideal para todo tipo de superficies duras.

ECO: 1h10/1h30/2h40min*

Para suelos poco sucios y superficies delicadas: estantes, marcos, cortinas, etc.

PAUSE:

Apagado temporal durante el uso.

Los LED indican los modos de potencia. En el modo BOOST, las tres luces verdes parpadearán simultáneamente.

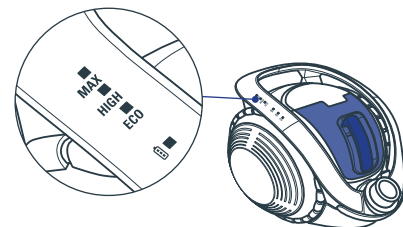

*en función del modelo.

BOQUILLA DE SUCCIÓN

La boquilla de 2 posiciones está equipada con un interruptor de pedal que permite cambiar entre la posición para alfombra o superficie dura.

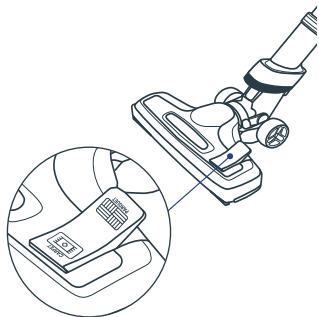

PARQUÉ

Posición para superficie dura, compatible con parquet de madera, azulejos, linóleo, etc.



ALFOMBRA

Posición de alfombra, perfecta para aspirar en profundidad cualquier alfombra.

MANDO A DISTANCIA

El aparato se controla mediante un mando a distancia integrado en el mango. Funciona mediante una pila redonda tipo CR2032.

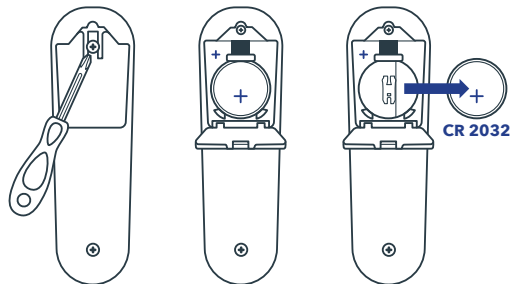

Recomendamos cambiar la pila cada 18 meses.

En caso de pérdida o daños en el mando a distancia, puedes encender el aparato pulsando el botón de encendido de forma prolongada

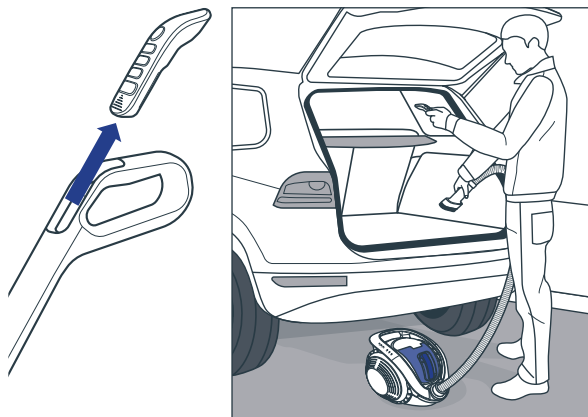

Puedes extraer el mando a distancia para realizar la limpieza únicamente con el tubo flexible (ideal para limpiar el coche, por ejemplo).

¿Cómo se utiliza el mando a distancia?



BATERÍA Y CARGA



LA CARGA COMPLETA DE LA BATERÍA TARDA 4 HORAS.

Para cargar el aparato, puedes elegir entre dos opciones:

OPCIÓN 1

Conecta el cargador directamente a la aspiradora: inserta primero la toma y, a continuación, enchúfala.

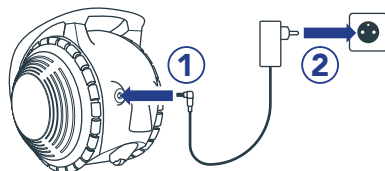

OPCIÓN 2

Conecta el cargador a la batería. Para ello, quita la batería del aparato, inserta la toma y, a continuación, enchufa el cargador.

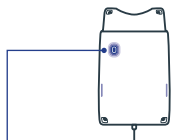
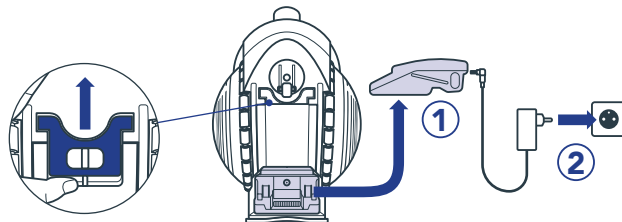

Luz azul encendida:
la batería se está
cargando.

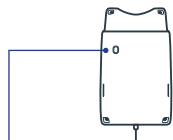

Luz azul apagada:
la batería está cargada.

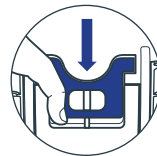
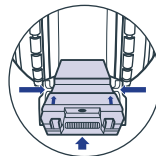

Escanea el código para
obtener más información
sobre la batería y su carga.



ESTADO DE LA BATERÍA

El aparato indica el nivel de carga:

- 3 luces LED azules: 100% de carga.
- 2 luces LED azules: 60% de carga.
- 1 luz LED azul intermitente: el aparato debe recargarse.

Si la batería está completamente agotada, un LED azul parpadeará varias veces.

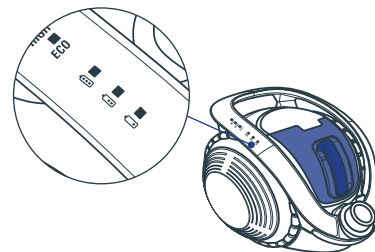

FUNCIÓN FLEX

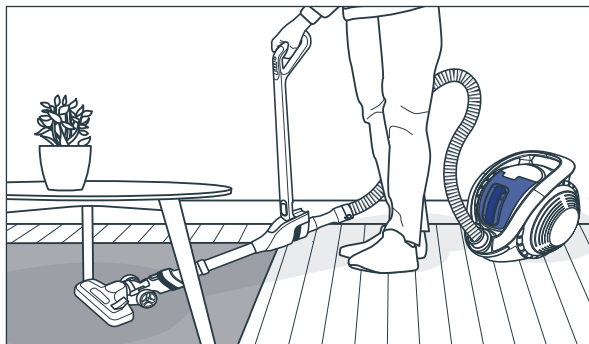

El aparato está equipado con tecnología Flex. Esta tecnología permite llegar cómodamente a las zonas más alejadas debajo de los muebles de altura baja. Para activarla, desliza el botón Flex hacia arriba.

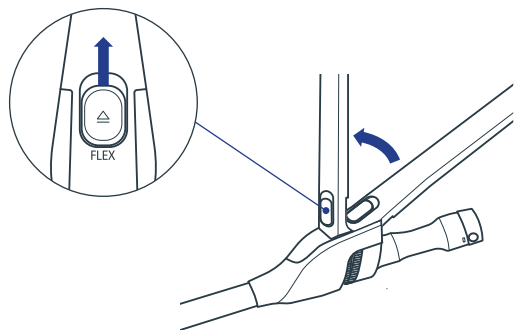

ACCESORIOS

El aparato cuenta con 2 cepillos integrados para una limpieza fácil. Puedes utilizarlos para aspirar la mayoría de superficies.

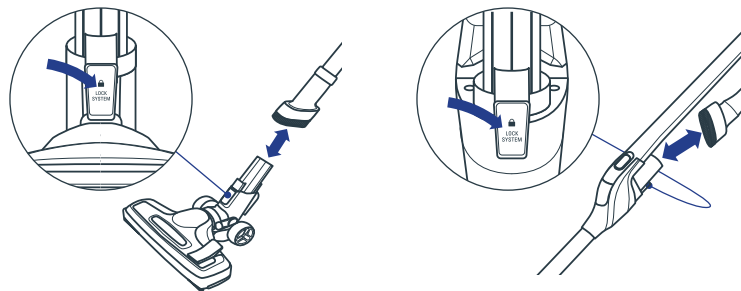

Para la limpieza de zonas específicas, utiliza accesorios adicionales: insértalos en uno de los tubos a la máxima profundidad.

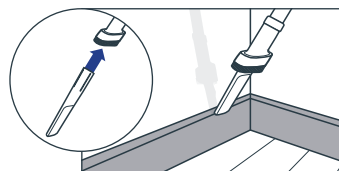

Utiliza **la boquilla para ranuras** para aspirar lugares de difícil acceso.

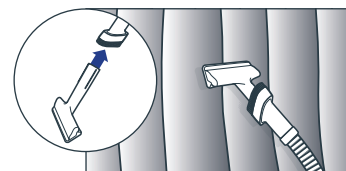

Utiliza **el cepillo para sofás** para aspirar tejidos de sofás, cortinas o colchones.

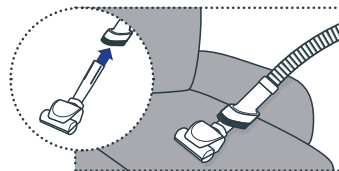

Utilice el **cepillo mini turbo en modo MAX o BOOST para aspirar a fondo sofás, colchones y alfombrillas para coches.

**disponible solo en algunos modelos.



MANTE- NIMIEN- TO

Escanea el código con tu teléfono o lector de QR para sacar el máximo partido a los consejos de mantenimiento y obtener el mejor rendimiento.



VACIAR EL DEPÓSITO DE POLVO

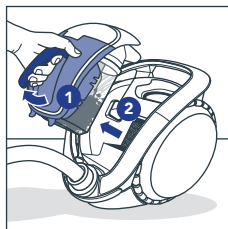
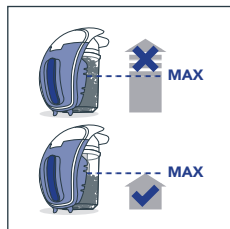

MANTENIMIENTO DEL FILTRO CICLÓNICO

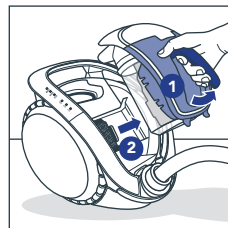
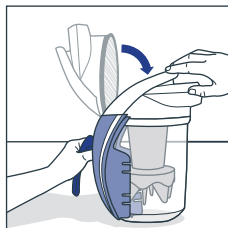
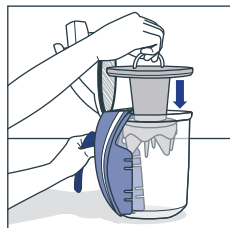
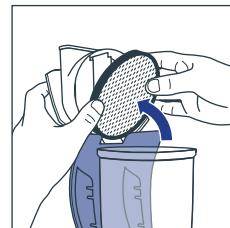
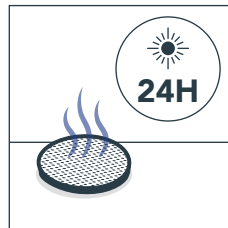
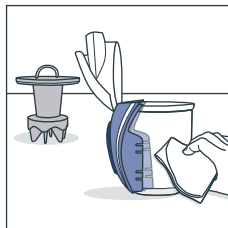
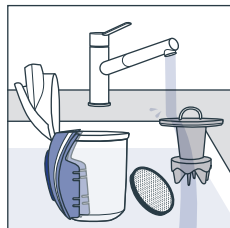

Lava con agua el filtro ciclónico después de cada vaciado del depósito de polvo. Sustitúelo una vez al año. Para comprar uno nuevo, busca la referencia Rowenta ZR007700.

MANTENIMIENTO DEL FILTRO DEL MOTOR

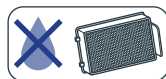

1 VEZ
AL MES

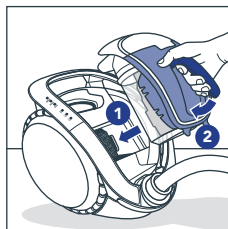
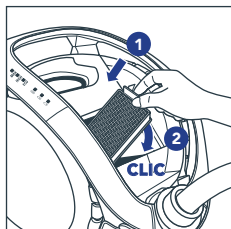
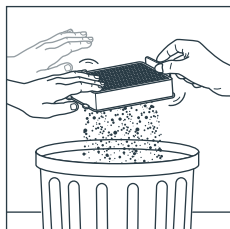
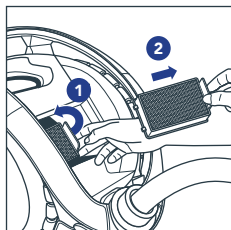
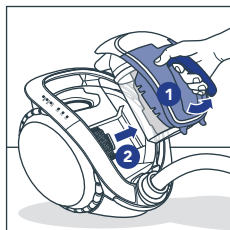

1 VEZ
AL AÑO

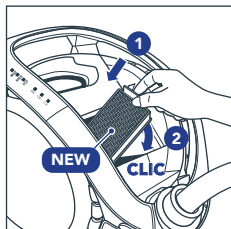
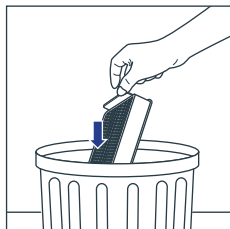

Sustituye el filtro del motor una vez al año.

Para comprar uno nuevo, busca la referencia Rowenta ZR007700.

LIMPIEZA DEL CEPILLO MINI TURBO

Extrae siempre el cepillo mini turbo antes de limpiarlo (disponible en algunos modelos).

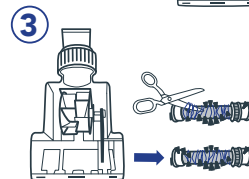
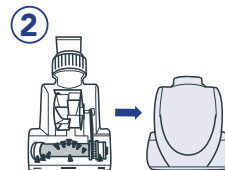

ALMACENAJE

OPCIÓN 1

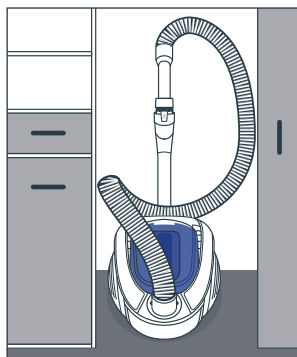
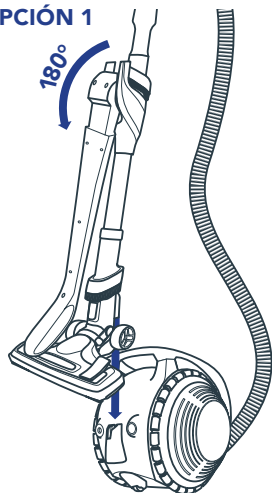

OPCIÓN 2

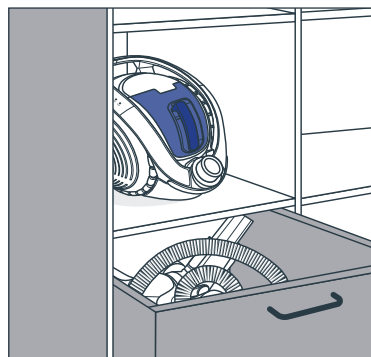
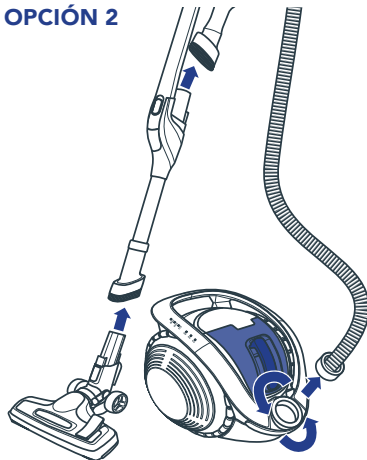

PRECAUCIÓN

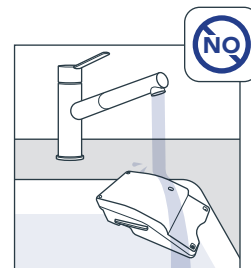
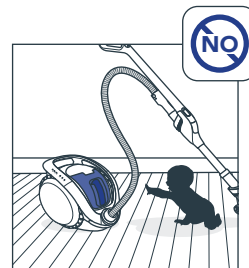

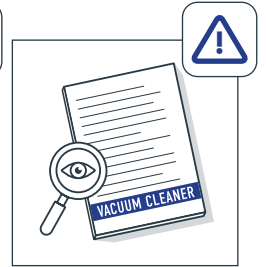
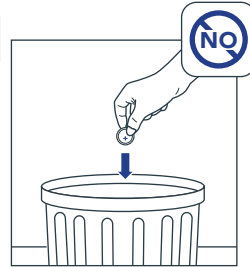
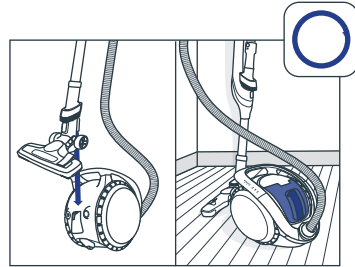
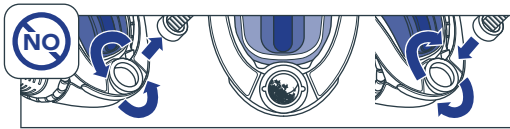
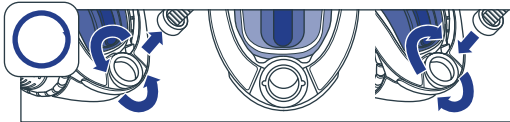
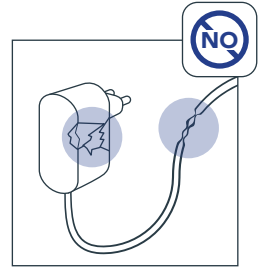
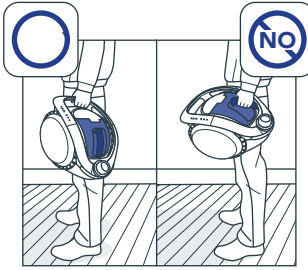
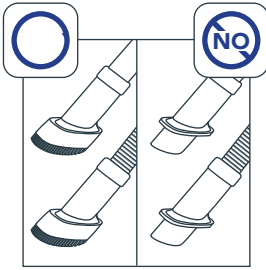
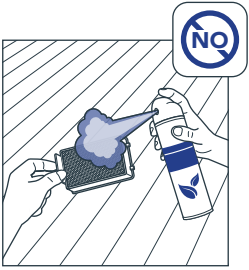
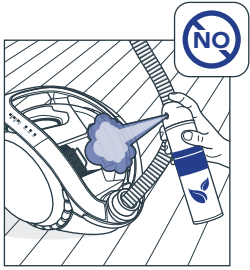
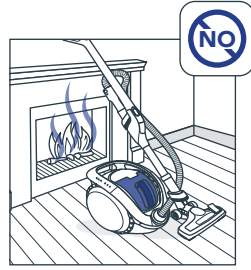
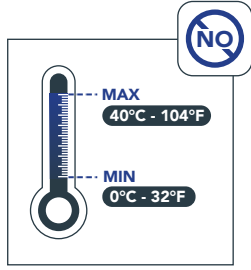



Obrigado por comprar um Rowenta X-Ô.

O seu aparelho está equipado com as mais recentes tecnologias Rowenta.

Leia atentamente este manual para aproveitar ao máximo as capacidades do seu aparelho.

Efetue a leitura com a sua câmara do telemóvel ou leitor QR para ver guias úteis em vídeo sobre como montar o aparelho.



MONTAGEM



Aviso!
Consulte a página 56 para saber que medida tomar antes da primeira utilização.

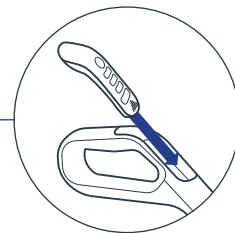
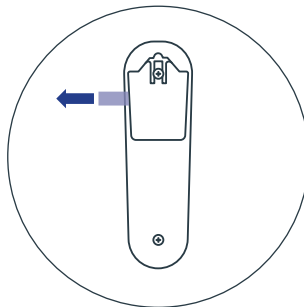

O SEU APARELHO TERÁ DE ESTAR TOTALMENTE CARREGADO ANTES DA PRIMEIRA UTILIZAÇÃO

Primeiro, ligue a tomada antes de ligar à corrente.

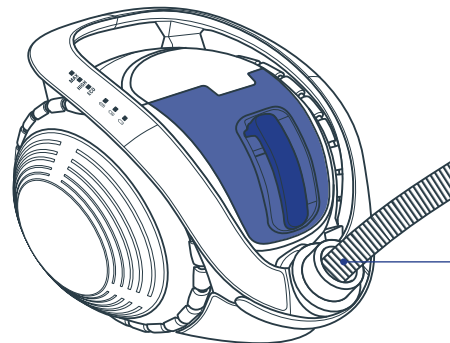
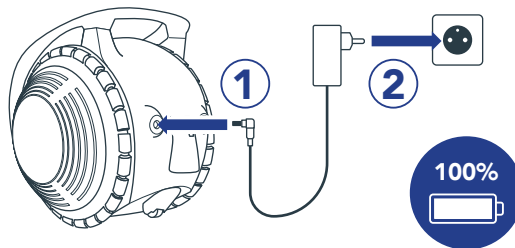

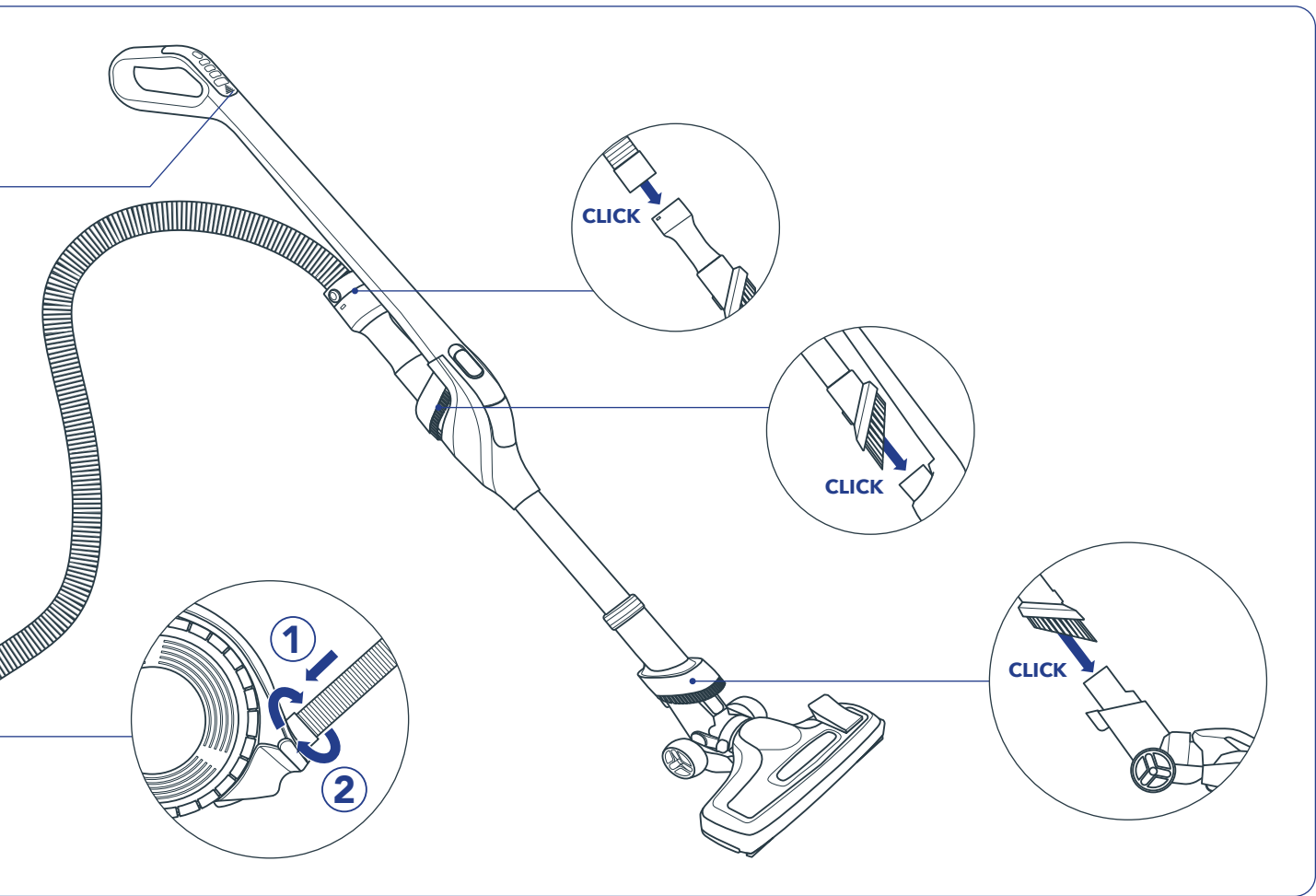

ANTES DA PRIMEIRA UTILIZAÇÃO



Como emparelhar o meu comando?



Emparelhe o comando antes da primeira utilização.

A ser feito apenas uma vez.

	O que tem de fazer:	O que pode ver no seu aparelho
1	Retire a patilha de plástico antes da primeira utilização.	
2	<u>Para ligar o aparelho:</u> Prima o botão on/off.	Os LED azuis da bateria estão acesos.
3.1	<u>Iniciar o emparelhamento:</u> Prima simultaneamente os botões MAX e II (pausa).	- Ouvirá um aviso sonoro de confirmação - Os LED azuis da bateria e os LED indicadores de velocidade verdes piscam alternadamente
3.2	<u>Confirmar o emparelhamento</u> Após o passo 3.1, prima imediatamente o botão II . (enquanto os LED estão a piscar alternadamente)	- Os LED azuis ficam acesos - Ouvirá dois avisos sonoros Se não ouvir os dois avisos sonoros após 10 segundos: o emparelhamento falhou. Desligue o aparelho e comece a partir do passo 2.

➤ **Parabéns! Emparelhou com êxito o seu comando.**

LIGAR/DESLIGAR O BOTÃO DE ALIMENTAÇÃO

Para ligar e desligar o aparelho, prima o botão de alimentação. Para começar a aspirar, prima a velocidade ECO (Ecológica), HIGH (Alta) ou MAX (Máxima) no comando.

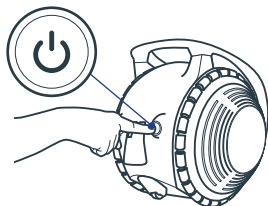

MODO DE POTÊNCIA

O seu aparelho tem 4 modos de potência para diferentes tarefas. Altere os modos de limpeza utilizando os botões do comando e ajuste a potência:

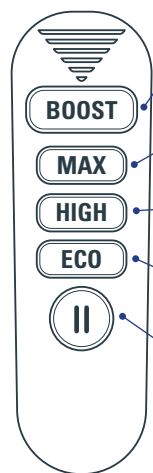

BOOST: 5/10min*

Limpeza intensiva para sujidade enraçada.

NOTA: Continue a premir o botão BOOST (Aumento da intensidade) para utilizar este modo.

MAX: 20/40min*

Limpeza intensiva e pó incrustado. Ideal para todos os tipos de carpetes.

HIGH: 40/50/90min*

Para limpeza de manutenção. Ideal para todos os tipos de pisos duros.

ECO: 1h10/1h30/2h40min*

Para pisos ligeiramente sujos e superfícies delicadas: prateleiras, caixilhos, cortinas, etc.

PAUSA:

Encerramento temporário durante a utilização.

Os LED indicam os modos de potência. No modo BOOST (Aumento da intensidade), as três luzes verdes piscam em simultâneo.

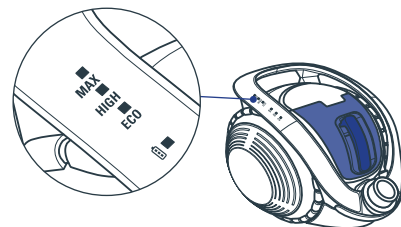

*consoante o modelo.

TUBO DE SUÇÃO

O tubo de 2 posições está equipado com um interruptor de pedal que lhe permite alternar entre a posição de carpete ou piso duro.

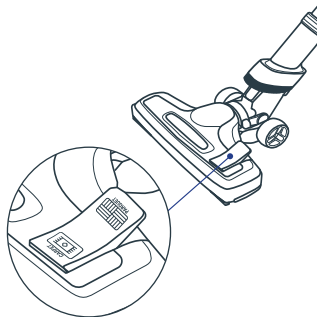

PARQUET

Posição de piso duro, compatível com parquet de madeira, mosaicos, linóleo, etc.



TAPETE

Posição de carpete, perfeita para aspirar em profundidade qualquer carpete ou tapete.

COMANDO

O seu aparelho é gerido por um comando, integrado na pega. É alimentado por uma pilha redonda do tipo CR2032.

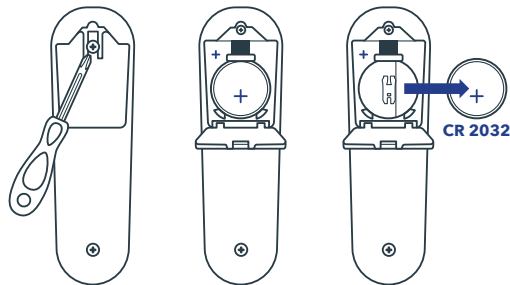

Recomendamos que substitua a pilha a cada 18 meses.

Em caso de perda ou danos no comando, pode continuar a ligar o seu aparelho premindo continuamente o botão ON (Ligar)

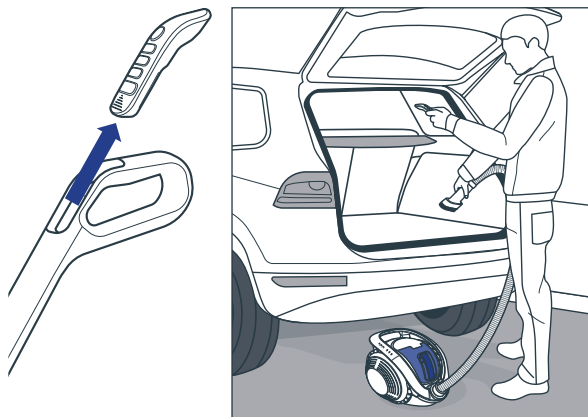

Pode retirar o comando para realizar todas as suas sessões de limpeza apenas com o tubo flexível (ideal para limpar o seu automóvel, por exemplo).

Como utilizar o meu comando?



BATERIA E CARGA



O CARREGAMENTO TOTAL DA BATERIA DEMORA 4 HORAS.

Para carregar o aparelho, pode escolher entre duas opções:

OPÇÃO 1

Ligue o carregador diretamente ao aspirador: primeiro, introduza a tomada e, em seguida, ligue à ficha.

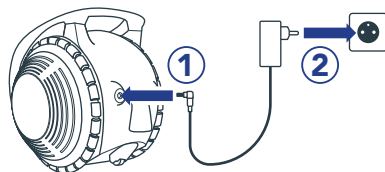

OPÇÃO 2

Ligue o carregador à bateria. Para tal, retire a bateria do aparelho, introduza a tomada e, em seguida, ligue o carregador.

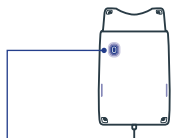
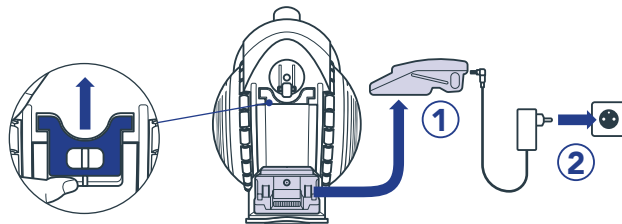

Luz azul acesa:
a bateria está a carregar.

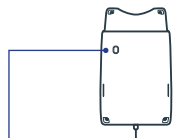

Luz azul apagada:
a bateria está carregada.

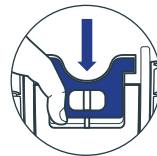
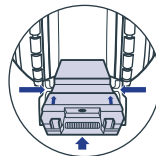

Efetue a leitura para saber mais sobre a bateria e o respetivo carregamento.



ESTADO DA BATERIA

O seu aparelho indica o nível de carga:

- 3 LED azuis acesos: 100% carregada.
- 2 LED azuis acesos: 60% carregada.
- 1 LED azul intermitente: o aparelho tem de ser recarregado.

Se a bateria estiver totalmente descarregada, 1 LED azul pisca algumas vezes.

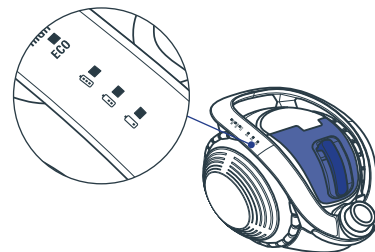

FUNÇÃO FLEX

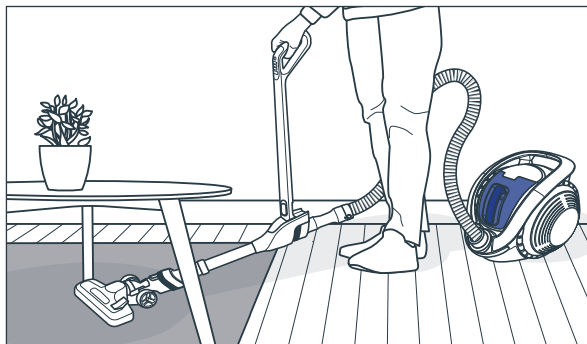

O seu aparelho está equipado com tecnologia Flex. Esta tecnologia permite-lhe chegar às áreas mais afastadas sob móveis baixos sem esforço.

Para ativá-la, deslize o botão Flex para cima.

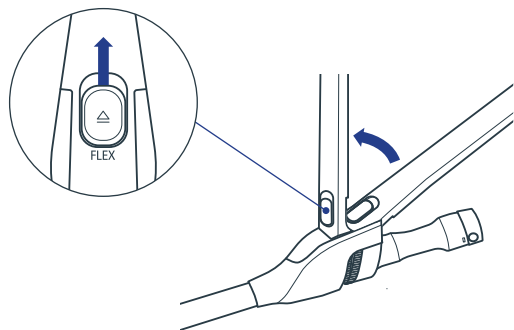

ACESSÓRIOS

O seu aparelho tem 2 escovas integradas para limpeza fácil do pó. Pode utilizá-las para aspirar a maioria das superfícies.

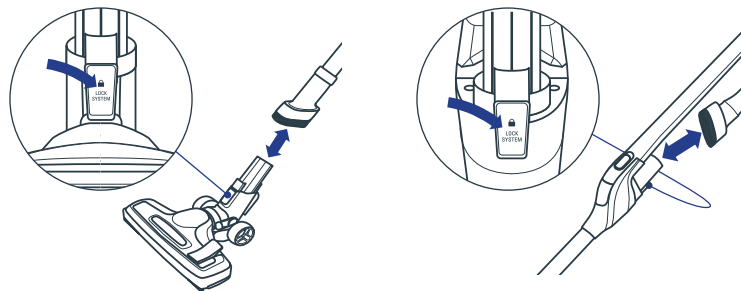

Para limpeza de áreas específicas, utilize acessórios adicionais: insira-os num dos tubos até à profundidade máxima.

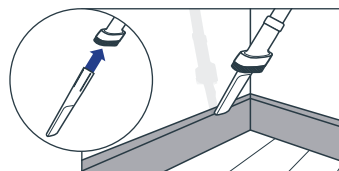

Utilize a **ferramenta** para fendas para aspirar locais de difícil acesso.

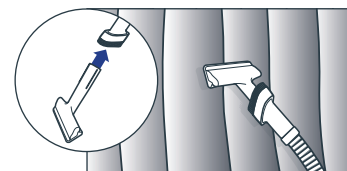

Utilize a **escova para sofás** para aspirar tecidos como sofás, cortinas ou colchões.

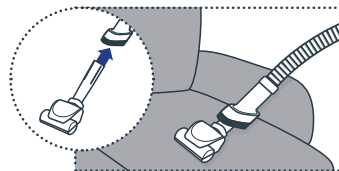

**Para aspirar com profundidade os seus sofás, colchões ou tapetes de carro, utilize a escova mini turbo no modo MAX ou BOOST.

**disponível apenas em alguns modelos.

X-Ô

MANUTENÇÃO

Efetue a leitura com o seu telefone ou leitor QR para tirar o máximo partido dos conselhos de manutenção e obter o melhor desempenho.



ESVAZIAR O COLETOR DE PÓ

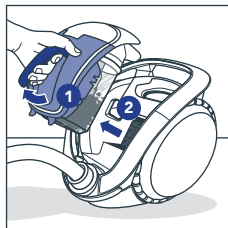
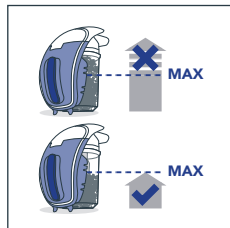

MANUTENÇÃO DO FILTRO CICLÓNICO

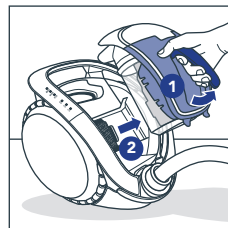
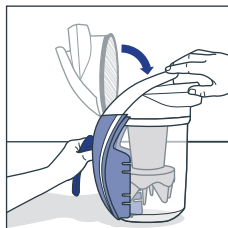
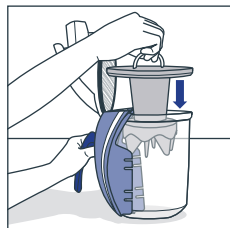
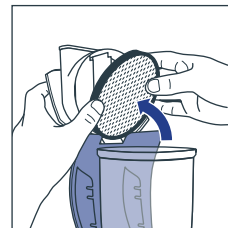
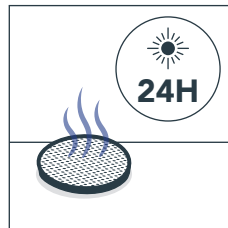
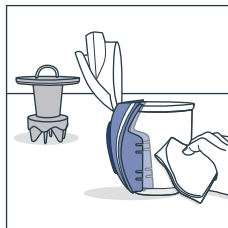
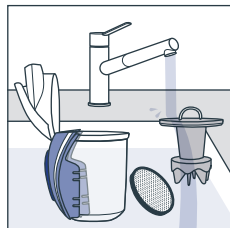

Lave o filtro ciclónico com água após cada esvaziamento do coletor de pó. Substitua-o uma vez por ano. Para comprar um novo, procure a referência Rowenta ZR007700.

MANUTENÇÃO DO FILTRO DO MOTOR



1X
MÊS

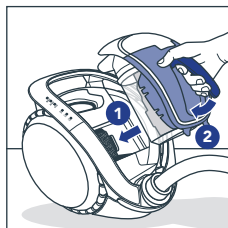
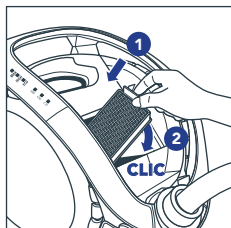
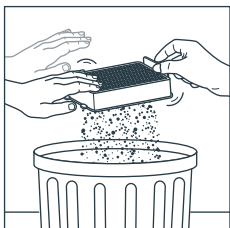
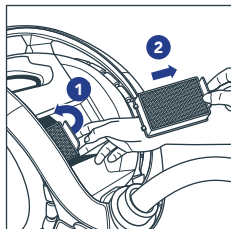
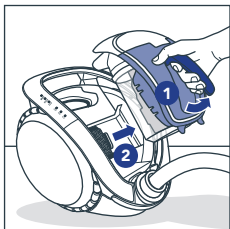

1X
ANO

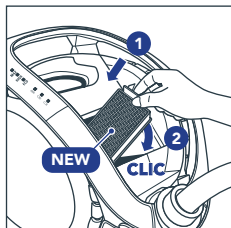
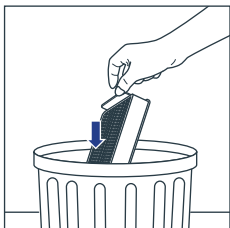

Substitua o filtro do motor uma vez por ano. Para comprar um novo, procure a referência Rowenta ZR007700.

LIMPAR A MINI ESCOVA TURBO

Retire sempre o acessório da mini escova turbo antes de proceder à limpeza (disponível em alguns modelos).

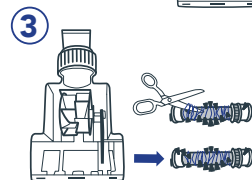
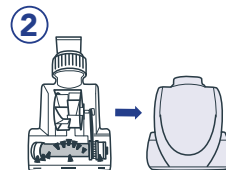

ARRUMAÇÃO

OPÇÃO 1

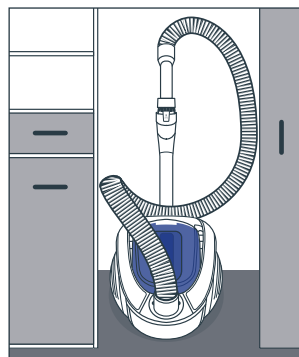
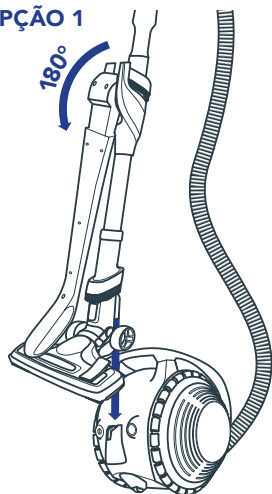

OPÇÃO 2

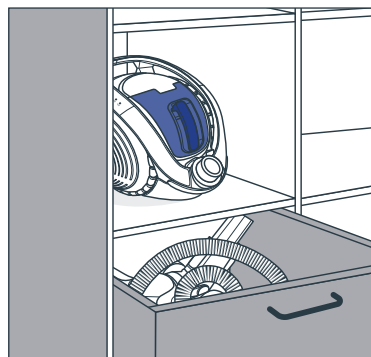
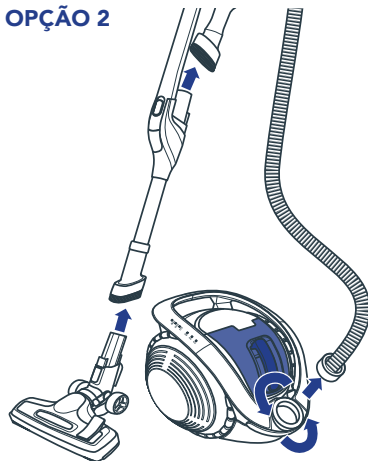

CUIDADO

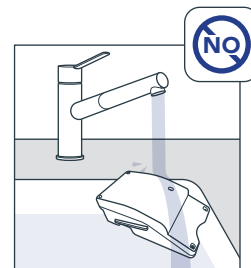

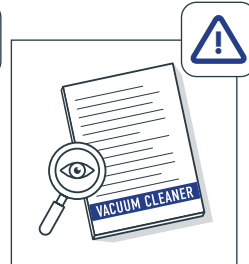
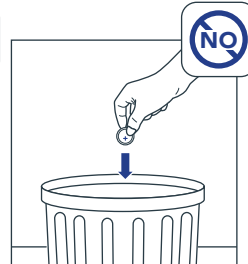
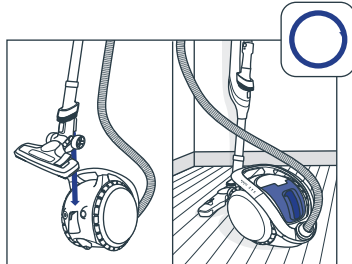
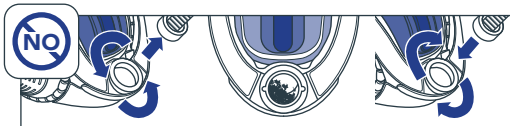
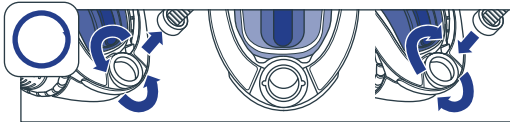
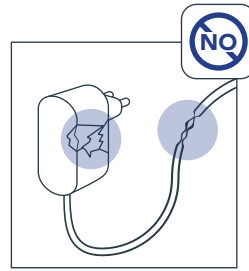
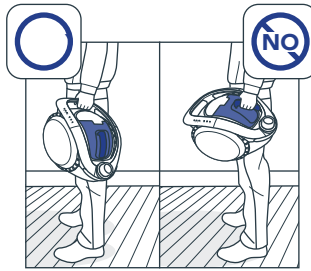
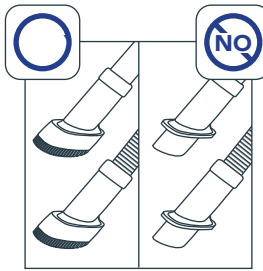
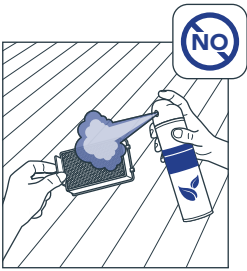
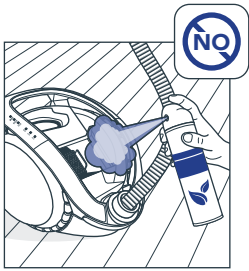
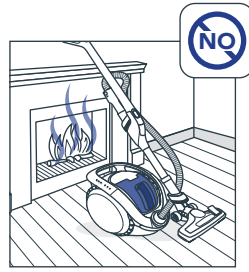
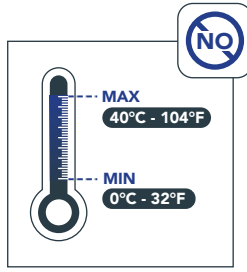



Ευχαριστούμε που επιλέξατε να αγοράσετε την ηλεκτρική σκούπα χωρίς καλώδιο Rowenta.

Η συσκευή σας διαθέτει τις πιο πρόσφατες τεχνολογίες της Rowenta.

Διαβάστε προσεκτικά αυτό το εγχειρίδιο για να αξιοποιήσετε στο έπακρο τις δυνατότητες της συσκευής σας.

Για να δείτε ένα χρήσιμο βίντεο με οδηγίες σχετικά με τον τρόπο συναρμολόγησης της συσκευής σας, σαρώστε με την κάμερα του τηλεφώνου ή με ένα πρόγραμμα ανάγνωσης κωδικών QR.



ΣΥΝΑΡΜΟΛΟΓΗΣΗ



Προσοχή! Μια ενέργεια που πρέπει να εκτελεστεί πριν από την πρώτη χρήση. Ανατρέξτε στη σελίδα 66.

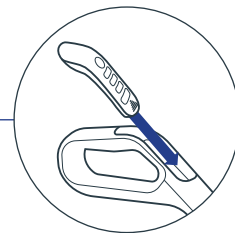
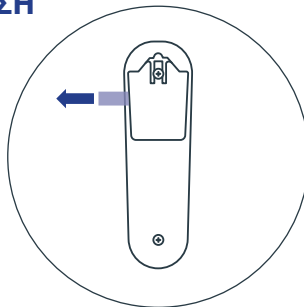

Η ΣΥΣΚΕΥΗ ΣΑΣ ΘΑ ΠΡΕΠΕΙ ΝΑ ΕΙΝΑΙ ΠΛΗΡΩΣ ΦΟΡΤΙΣΜΕΝΗ ΠΡΙΝ ΑΠΟ ΤΗΝ ΠΡΩΤΗ ΧΡΗΣΗ

Συνδέστε πρώτα το φις στη συσκευή πριν συνδέσετε τον φορτιστή στην πρίζα.

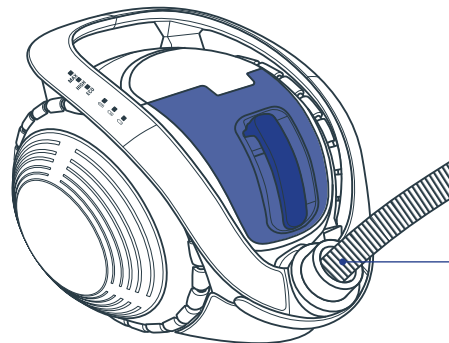
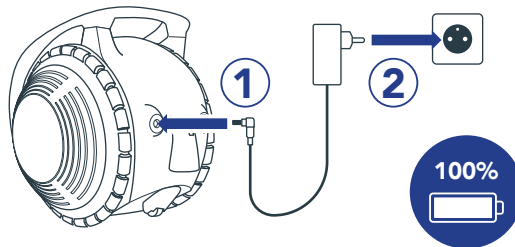

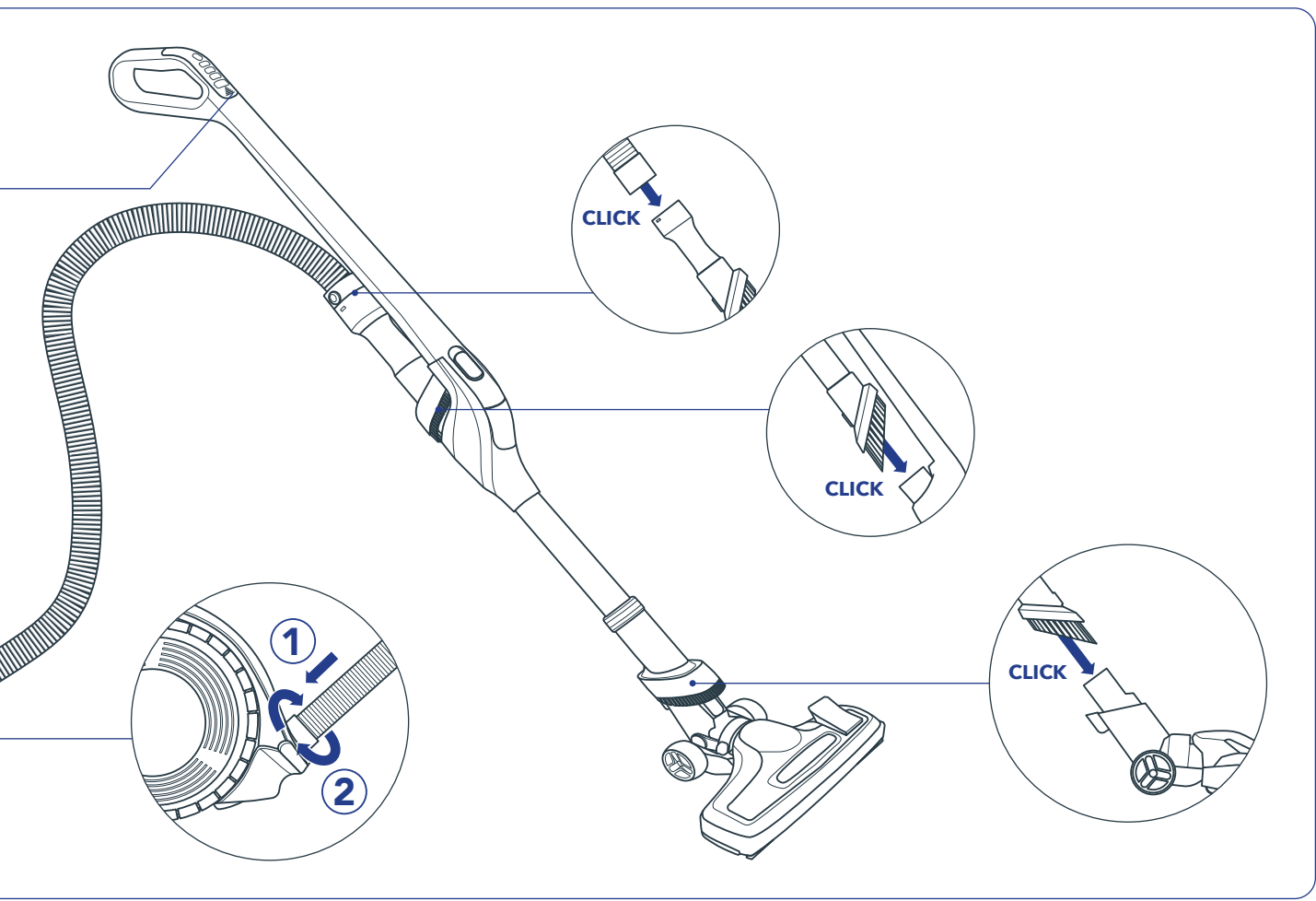

ΠΡΙΝ ΑΠΟ ΤΗΝ ΠΡΩΤΗ ΧΡΗΣΗ



Πώς γίνεται η σύζευξη του τηλεχειριστηρίου;



Συζεύξτε το τηλεχειριστήριο πριν από την πρώτη χρήση

Αυτό θα πραγματοποιηθεί μόνο μία φορά.

	Τι πρέπει να κάνετε:	Τι μπορείτε να δείτε πάνω στη συσκευή σας
1	Αφαιρέστε την πλαστική γλωττίδα πριν από την πρώτη χρήση.	
2	Για ενεργοποίηση της συσκευής: Πατήστε το κουμπί ON/OFF.	Οι μπλε λυχνίες LED της μπαταρίας ανάβουν.
3.1	Εκτέλεση σύζευξης: Πατήστε ταυτόχρονα τα κουμπιά MAX και II .	- Θα ακούσετε έναν ήχο επιβεβαίωσης - Οι μπλε λυχνίες LED της μπαταρίας και οι πράσινες ενδεικτικές λυχνίες LED ταχύτητας αναβοσβήνουν εναλλάξ
3.2	Επιβεβαίωση σύζευξης: Πατήστε το κουμπί αμέσως μετά το βήμα 3.1 II . (ενώ οι λυχνίες LED αναβοσβήνουν εναλλάξ)	- Οι μπλε λυχνίες LED εξακολουθούν να είναι αναμμένες - Θα ακούσετε έναν διπλό ήχο Αν δεν ακούσετε τον διπλό ήχο μετά από 10 δευτερόλεπτα: η σύζευξη απέτυχε. Απενεργοποιήστε τη συσκευή σας και ξεκινήστε ξανά από το βήμα 2.

> Συγχαρητήρια! Συζεύξατε με επιτυχία το τηλεχειριστήριό σας.

ΚΟΥΜΠΙ ΛΕΙΤΟΥΡΓΙΑΣ ON/OFF

Για να ενεργοποιήσετε και να απενεργοποιήσετε τη συσκευή σας, πατήστε σύντομα το κουμπί λειτουργίας.

Για να ξεκινήσετε το σκούπισμα, επιλέξτε την ταχύτητα ECO, HIGH ή MAX στο τηλεχειριστήριό σας.

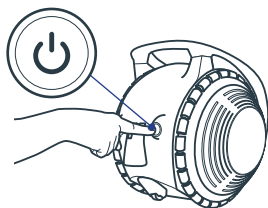

ΛΕΙΤΟΥΡΓΙΑ ΙΣΧΥΟΣ

Η συσκευή σας διαθέτει 4 λειτουργίες ισχύος. Αλλάξτε λειτουργίες καθαρισμού χρησιμοποιώντας τα κουμπιά του τηλεχειριστηρίου σας και προσαρμόστε την ισχύ:

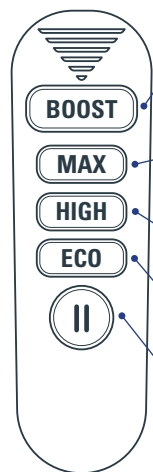

BOOST: 5/10 λεπτά*

Εντατικός καθαρισμός για ρύπους που έχουν ενσωματωθεί στα δάπεδα.

Σημείωση: Συνεχίστε να πατάτε το κουμπί BOOST για να χρησιμοποιήσετε αυτήν τη λειτουργία.

MAX: 20/40 λεπτά*

Εντατικός καθαρισμός για ρύπους που έχουν ξεραθεί. Ιδανικό για κάθε τύπο χαλιών.

HIGH: 40/50/90 ΛΕΠΤΑ*

Για καθαρισμό συντήρησης. Ιδανικό για κάθε τύπο σκληρών δαπέδων.

ECO: 1 ώρα και 10 λεπτά/1 ώρα και 30 λεπτά/2 ώρες και 40 λεπτά*

Για ελαφρώς λερωμένα δάπεδα και ευαίσθητες επιφάνειες: ράφια, πλαίσια, κουρτίνες κ.λπ.

ΠΑΥΣΗ:

Προσωρινός τερματισμός λειτουργίας κατά τη διάρκεια της χρήσης.

Οι λυχνίες LED υποδηλώνουν τις λειτουργίες ισχύος.

Στη λειτουργία BOOST, και οι τρεις πράσινες λυχνίες θα αναβοσβήσουν αυτόματα.

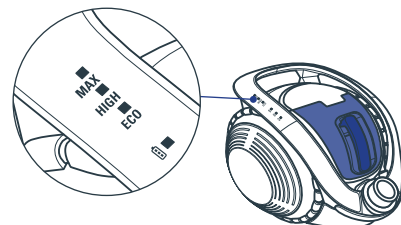

*ανάλογα με το μοντέλο.

ΠΕΛΜΑ ΑΝΑΡΡΟΦΗΣΗΣ

Το πέλμα 2 θέσεων διαθέτει έναν ποδοδιακόπτη που σας επιτρέπει να εναλλάσσετε μεταξύ της θέσης για χαλιά και της θέσης για σκληρά δάπεδα.

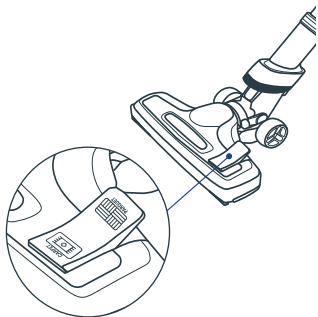

ΠΑΡΚΕ

Θέση για σκληρά δάπεδα, συμβατή με ξύλινα παρκέ δάπεδα, πλακάκια, λινόλεουμ κ.λπ.



ΧΑΛΙ

Θέση για χαλιά, ιδανική για καθαρισμό σε βάθος κάθε τύπου χαλιού ή μοκέτας.

ΤΗΛΕΧΕΙΡΙΣΤΗΡΙΟ

Η διαχείριση της συσκευής σας γίνεται από ένα τηλεχειριστήριο, που είναι ενσωματωμένο στη λαβή. Τροφοδοτείται από μια στρογγυλή μπαταρία τύπου CR2032.

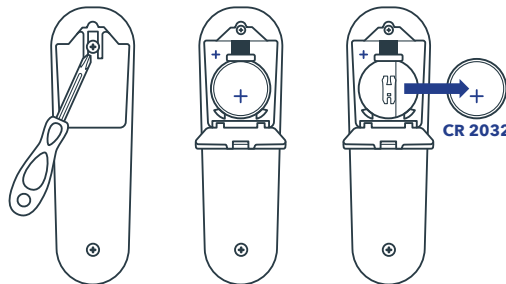

Συνιστούμε να αλλάζετε την μπαταρία κάθε 18 μήνες.

Σε περίπτωση απώλειας ή καταστροφής του τηλεχειριστηρίου σας, μπορείτε να ενεργοποιείτε τη συσκευή σας πατώντας παρατεταμένα το κουμπί ON.

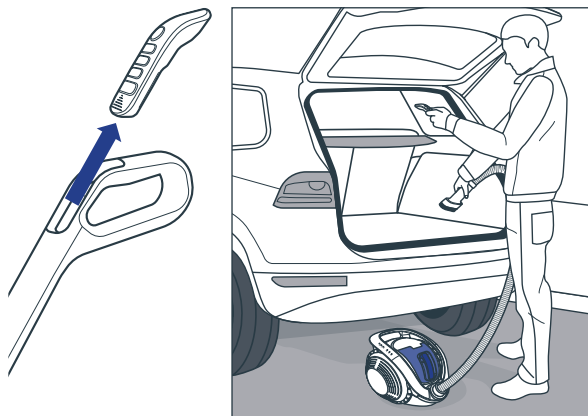

Μπορείτε να αποσυνδέσετε το τηλεχειριστήριο για να εκτελέσετε όλες τις εργασίες καθαρισμού μόνο με τον εύκαμπτο σωλήνα (ιδανικό για τον καθαρισμό του αυτοκινήτου σας, για παράδειγμα).

Πώς χρησιμοποιώ το τηλεχειριστήριο;



ΜΠΑΤΑΡΙΑ ΚΑΙ ΦΟΡΤΙΣΗ



Η ΠΛΗΡΗΣ ΦΟΡΤΙΣΗ ΤΗΣ ΜΠΑΤΑΡΙΑΣ ΔΙΑΡΚΕΙ 4 ΩΡΕΣ.

Για να φορτίσετε τη συσκευή σας, μπορείτε να χρησιμοποιήσετε μία από τις δύο επιλογές:

ΕΠΙΛΟΓΗ 1

Συνδέστε απευθείας τον φορτιστή στην ηλεκτρική σκούπα: πρώτα εισαγάγετε το φις στη σκούπα και μετά συνδέστε τον φορτιστή στην πρίζα.

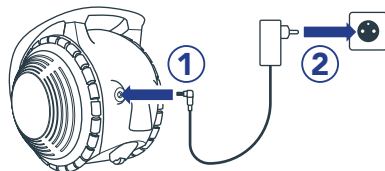

ΕΠΙΛΟΓΗ 2

Συνδέστε τον φορτιστή στην μπαταρία. Για να το κάνετε αυτό, αφαιρέστε την μπαταρία από τη συσκευή, εισαγάγετε το φις και, στη συνέχεια, συνδέστε τον φορτιστή στην πρίζα.

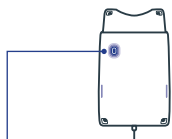
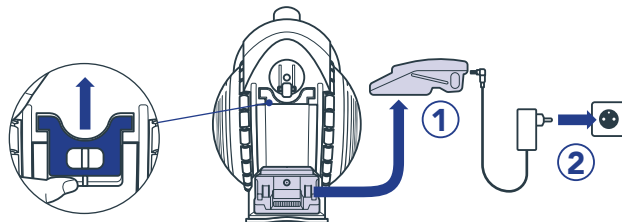

Μπλε λυχνία αναμμένη: η μπαταρία φορτίζει.

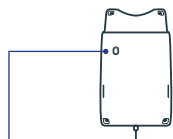

Μπλε λυχνία σβηστή: η μπαταρία έχει φορτίσει.

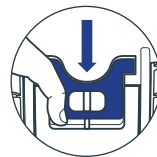
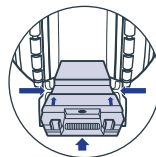

Σαρώστε για να μάθετε περισσότερα σχετικά με την μπαταρία και τη φόρτίσή της.



ΚΑΤΑΣΤΑΣΗ ΜΠΑΤΑΡΙΑΣ

Η συσκευή σας υποδεικνύει το επίπεδο φόρτισης:

- 3 μπλε λυχνίες LED αναμμένες: 100% φόρτιση.
- 2 μπλε λυχνίες LED αναμμένες: 60% φόρτιση.
- 1 μπλε λυχνία LED που αναβοσβήνει: η συσκευή χρειάζεται επαναφόρτιση.

Αν η μπαταρία είναι πλήρως αποφορτισμένη, 1 μπλε λυχνία LED αναβοσβήνει μερικές φορές.

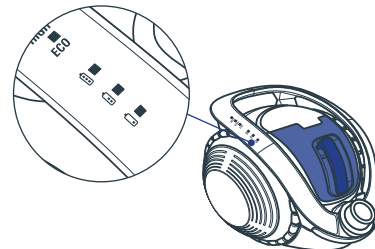

ΛΕΙΤΟΥΡΓΙΑ FLEX

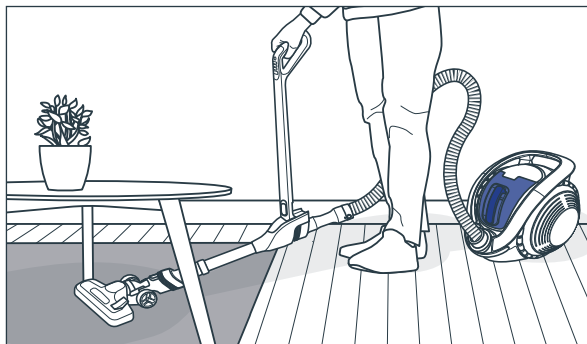

Η συσκευή σας διαθέτει την τεχνολογία Flex. Σας επιτρέπει να φτάσετε εύκολα ακόμα και στις πιο δυσπρόσιτες περιοχές, κάτω από χαμηλά έπιπλα.

Για να την ενεργοποιήσετε, σύρετε το κουμπί Flex προς τα επάνω.

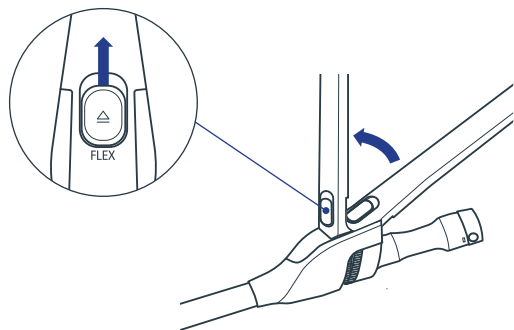

ΕΞΑΡΤΗΜΑΤΑ

Η συσκευή σας διαθέτει 2 ενσωματωμένα βουρτσάκια για εύκολο ξεσκόνισμα. Μπορείτε να τα χρησιμοποιήσετε για να σκουπίσετε τους περισσότερους τύπους επιφανειών.

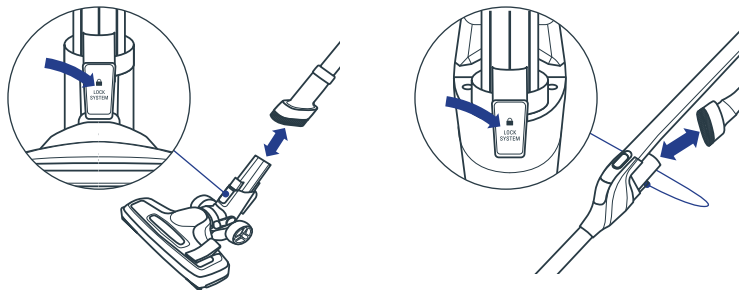

Για τον καθαρισμό ειδικών περιοχών, χρησιμοποιήστε επιπρόσθετα εξαρτήματα: εισαγάγετέ τα σε έναν από τους σωλήνες, στο μέγιστο βάθος.

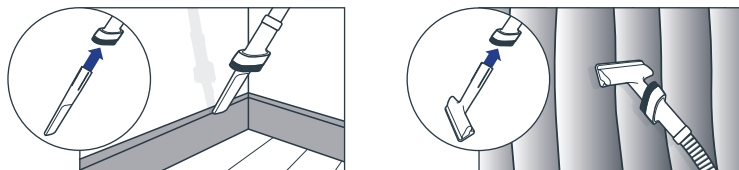

Χρησιμοποιήστε το **εργαλείο για τις εσοχές** για να σκουπίσετε σε δυσπρόσιτα σημεία.

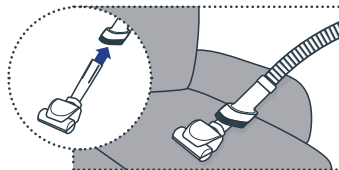

Χρησιμοποιήστε τη **βούρτσα για καναπέδες** για να σκουπίσετε πάνω σε υφάσματα, όπως καναπέδες, κουρτίνες ή στρώματα.

Χρησιμοποιήστε τη **μίνι βούρτσα τούρμπο στη λειτουργία MAX ή BOOST, για να σκουπίσετε σε βάθος τους καναπέδες, τα στρώματα ή τα πατάκια του αυτοκινήτου σας.

X-Ö

ΣΥΝΤΗΡΗΣΗ

Σαρώστε με το τηλέφωνό σας ή με το πρόγραμμα ανάγνωσης κωδικών QR για να αξιοποιήσετε στο έπακρο τις συμβουλές συντήρησης και να εξασφαλίσετε τη βέλτιστη απόδοση.



ΑΔΕΙΑΣΜΑ ΤΟΥ ΔΟΧΕΙΟΥ ΣΚΟΝΗΣ

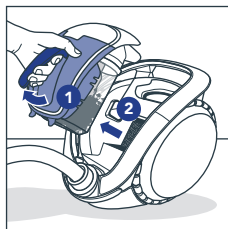
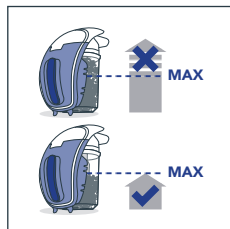

ΣΥΝΤΗΡΗΣΗ ΤΟΥ ΚΥΚΛΩΝΙΚΟΥ ΦΙΛΤΡΟΥ

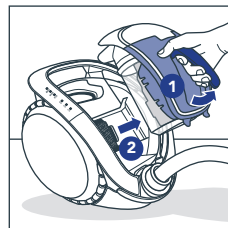
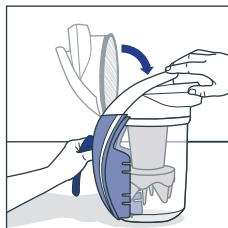
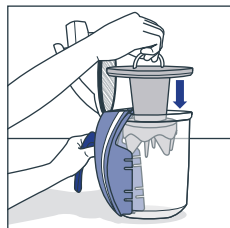
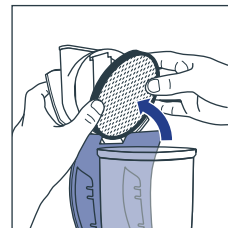
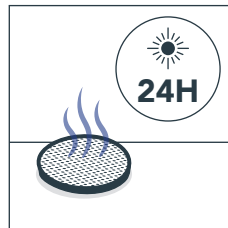
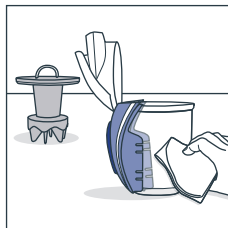
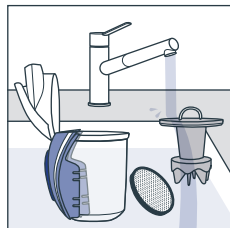

Πλένετε το κυκλωνικό φίλτρο με νερό έπειτα από κάθε άδειασμα του δοχείου σκόνης. Αντικαθιστάτε το μία φορά τον χρόνο. Για να αγοράσετε νέο φίλτρο, αναζητήστε τον κωδικό αναφοράς Rowenta ZR007700.

ΣΥΝΤΗΡΗΣΗ ΤΟΥ ΦΙΛΤΡΟΥ ΜΟΤΕΡ

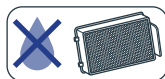

1Χ
ΜΗΝΑ

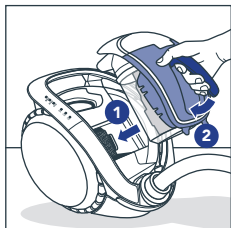
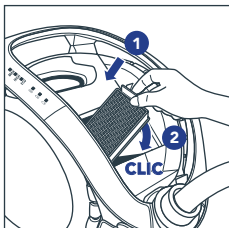
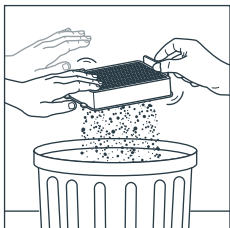
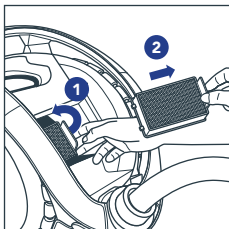
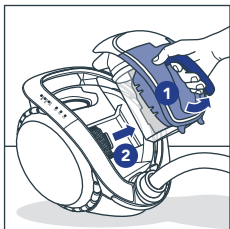

1Χ
ΕΤΟΣ

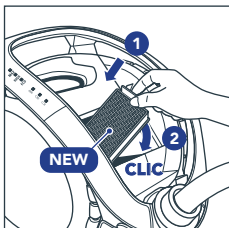
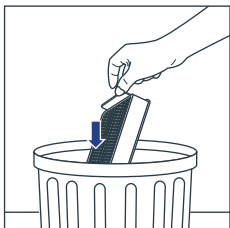

Αντικαθιστάτε το φίλτρο μοτέρ μία φορά τον χρόνο.

Για να αγοράσετε νέο φίλτρο, αναζητήστε τον κωδικό αναφοράς Rowenta ZR007700.

ΚΑΘΑΡΙΣΜΟΣ ΤΗΣ ΜΙΝΙ ΒΟΥΡΤΣΑΣ ΤΟΥΡΜΠΟ

Αφαιρείτε πάντα το εξάρτημα μίνι βούρτσας τούρμπο πριν από τον καθαρισμό (διαθέσιμο σε ορισμένα μοντέλα).

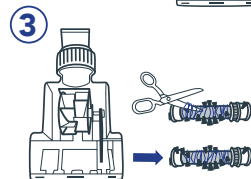
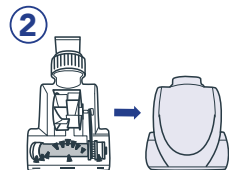

ΑΠΟΘΗΚΕΥΣΗ

ΕΠΙΛΟΓΗ 1

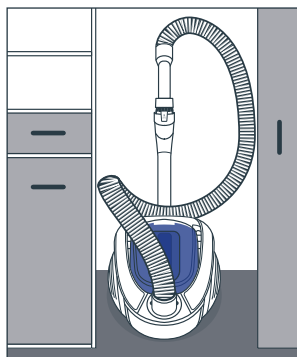
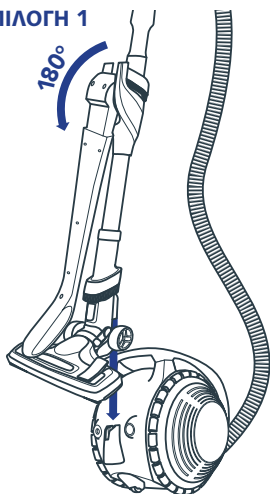

ΕΠΙΛΟΓΗ 2

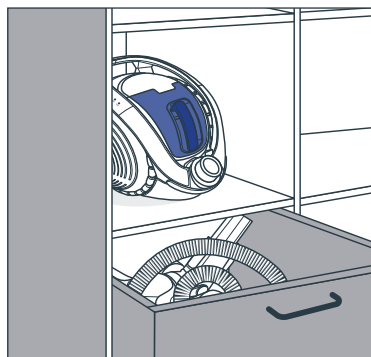
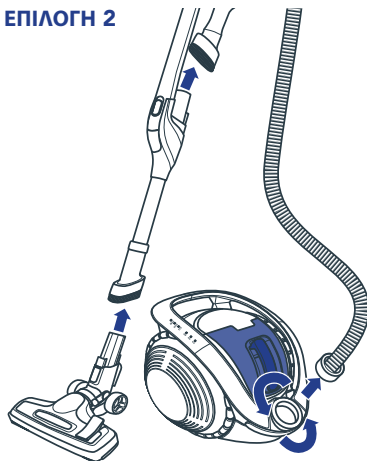

ΠΡΟΣΟΧΗ

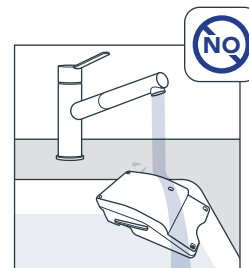

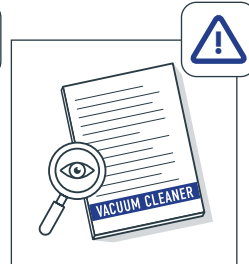
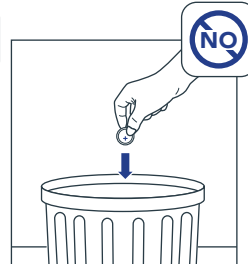
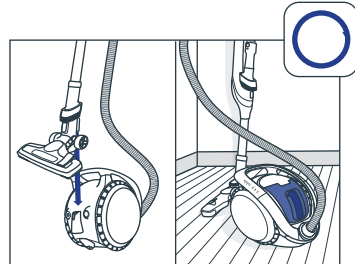
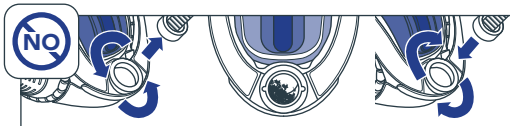
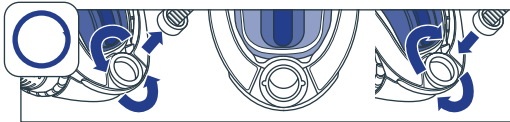
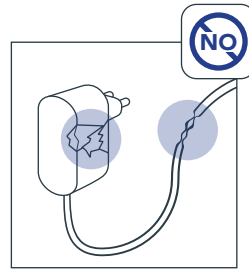
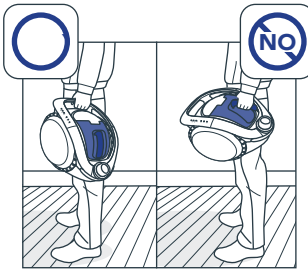
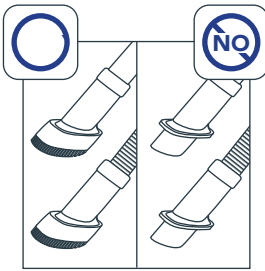
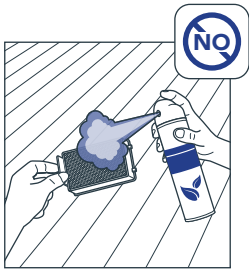
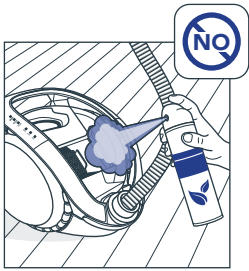
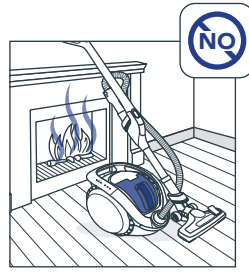
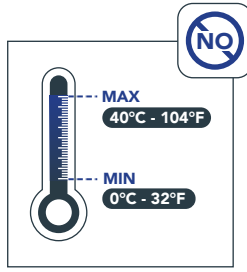



Дякуємо, що
вирішили придбати
Rowenta X-O.

Ваш прилад оснащено
останніми технологіями
Rowenta.

Уважно прочитайте цей
посібник, щоб отримати
максимум переваг від
свого приладу.

Скануйте за
допомогою камери
телефону або
пристрою для
зчитування QR-кодів,
щоб переглянути
корисний
відеопосібник про те,
як зібрати прилад.



ЗБИРАННЯ



**Попередження! Дію,
яку слід виконати
перед першим
використанням, див.
на сторінці 76.**

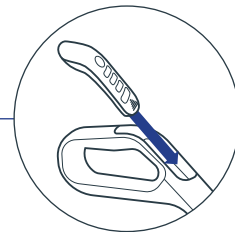
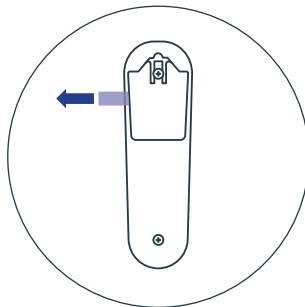

ПЕРЕД ПЕРШИМ ВИКОРИСТАННЯМ ПРИЛАД ПОТРІБНО ПОВНІСТЮ ЗАРЯДИТИ

Перед підключенням спочатку підключіть штекер.

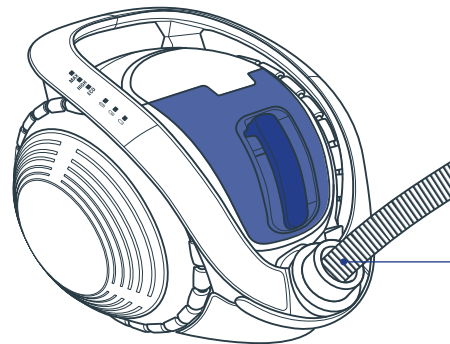
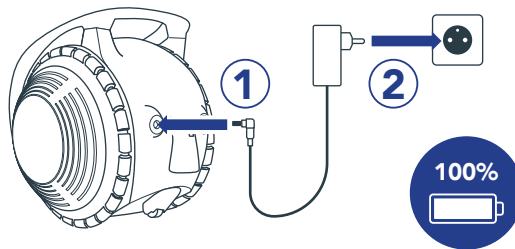

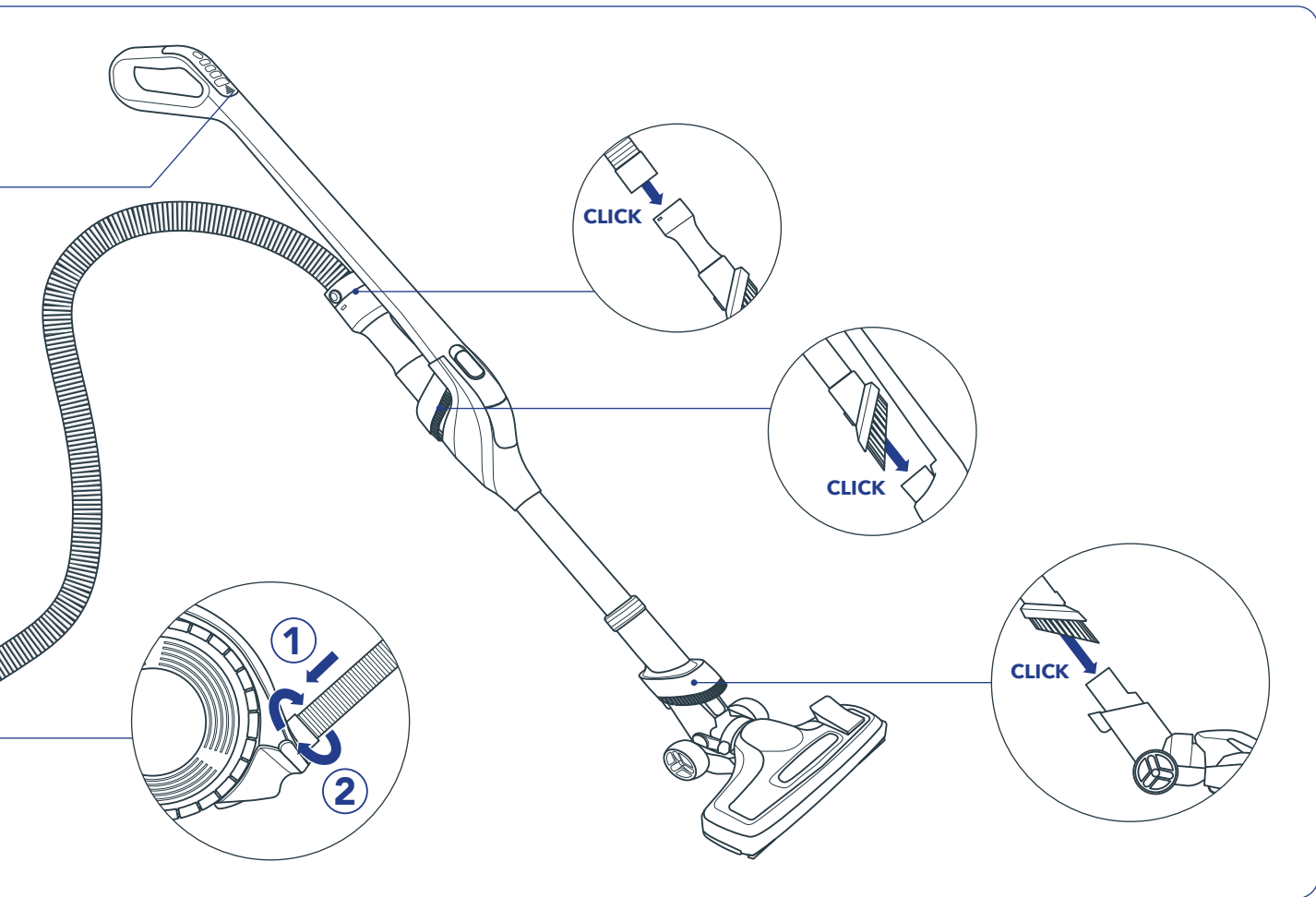

ПЕРЕД ПЕРШИМ ВИКОРИСТАННЯМ



Як підключитись до пульта дистанційного керування?



Перед першим використанням підключіться до пульта дистанційного керування

Зробити це можна лише один раз.

	Що потрібно зробити?	Що ви можете побачити на своєму приладі?
1	Перед першим використанням зніміть пластикову вкладку.	
2	Увімкнення приладу. Натисніть кнопку увімкнення/вимкнення	Почнуть світитись сині світлодіодні індикатори акумулятора.
3.1	Запуск процедури підключення. Одночасно натисніть кнопки MAX (МАКС.) і II (Пауза).	- Пролунає сигнал підтвердження - Сині світлодіодні індикатори акумулятора та зелені світлодіодні індикатори швидкості будуть блимати по черзі
3.2	Підтвердження підключення. Одразу після кроку 3.1 натисніть кнопку II . (поки світлодіодні індикатори блимають по черзі)	- Сині світлодіодні індикатори продовжують світитися - Пролунає подвійний сигнал Якщо ви не почули подвійний сигнал через 10 секунд: підключитись не вдалося. Вимкніть прилад і почніть знову з кроку 2.

➤ Вітаємо! Підключення до пульта дистанційного керування успішно виконано.

КНОПКА ЖИВЛЕННЯ ВВИМКНЕННЯ/ВИМКНЕННЯ

Щоб увімкнути або вимкнути прилад, коротко натисніть кнопку живлення.

Щоб початипилососити, натисніть кнопку ECO (ЕКО), HIGH (ВИСОКИЙ) або MAX (МАКС.) на пульта дистанційного керування.

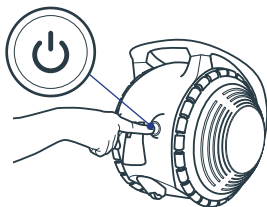

РЕЖИМ ПОТУЖНОСТІ

Прилад має 4 режими потужності. Змінійте режими чищення за допомогою кнопок пульта дистанційного керування та налаштуйте потужність.

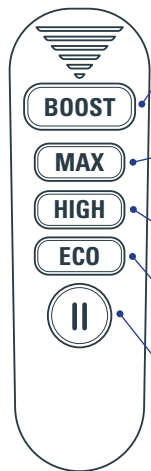

BOOST (ТУРБО): 5/10 хв*,

інтенсивне видалення забруднень.

Примітка. Натисніть кнопку BOOST (ТУРБО), щоб використовувати цей режим.

MAX (МАКС.): 20/40 хв*,

інтенсивне чищення та видалення засохлого бруду. Ідеально підходить для усіх типів килимів.

HIGH (ВИСОКИЙ): 40/50/90 хв*,

для чищення в режимі технічного обслуговування. Ідеально підходить для всіх типів твердих підлог.

ECO (ЕКО): 1 год 10 хв / 1 год 30 хв / 2 год 40 хв*,
для несильно забруднених підлог і делікатних поверхонь: полиць, рам, штор тощо.

PAUSE (ПАУЗА):

тимчасове вимкнення під час використання.

Світлодіодні індикатори вказують на режими потужності.

У режимі BOOST (ТУРБО) усі три зелені індикатори будуть блимати одночасно.

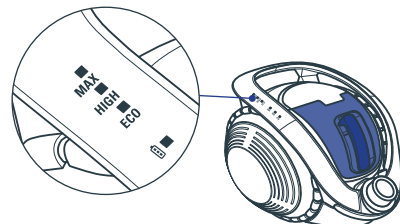

*Залежить від моделі.

НАСАДКА ДЛЯ ВСМОКТУВАННЯ

Ваша 2-позиційна насадка оснащена педальним перемикачем, який дозволяє перемикатися між положеннями обробки килима або твердої підлоги.



ПАРКЕТ

Тверда підлога, сумісно з дерев'яним паркетом, плиткою, лінолеумом тощо.



КИЛИМ

Положення обробки килима ідеально підходить для ретельної обробки пилососом будь-якого килима чи килимка.

ДИСТАНЦІЙНЕ КЕРУВАННЯ

Керуйте приладом за допомогою пульта дистанційного керування, вбудованого в ручку. Він живиться від круглої батарейки типу CR2032.

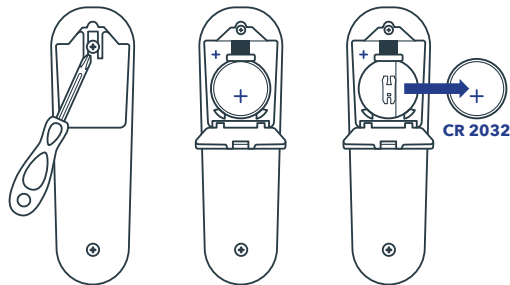

Радимо міняти батарейку кожні 18 місяців.

У разі втрати або пошкодження пульта дистанційного керування ви все одно можете ввімкнути прилад, натиснувши кнопку ВВІМКНЕННЯ

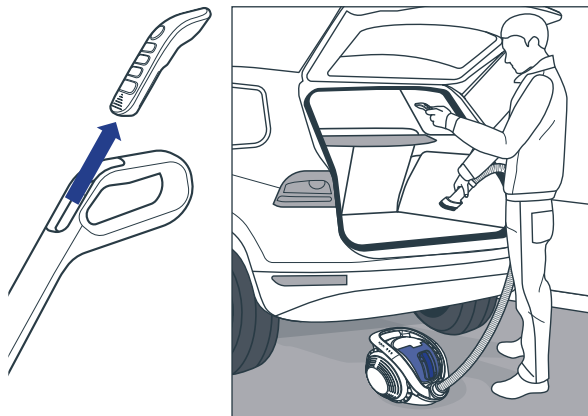

Ви можете від'єднати пульт дистанційного керування, щоб виконувати всі сеанси прибирання лише з використанням гнучкого шланга (ідеально підходить, наприклад, для чищення автомобіля).

Як користуватися пульту дистанційного керування?



АКУМУЛЯТОР І ЗАРЯДЖАННЯ



ПОВНИЙ ЦИКЛ ЗАРЯДЖАННЯ АКУМУЛЯТОРА ЗАЙМАЄ 4 ГОДИНИ.

Щоб зарядити прилад, можна вибрати один із двох варіантів.

ВАРІАНТ 1

Підключіть зарядний пристрій безпосередньо до пилососа: спочатку вставте штекер, а потім підключіть.

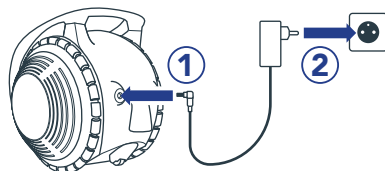

ВАРІАНТ 2

Підключіть зарядний пристрій до акумулятора. Для цього вийміть акумулятор із приладу, вставте штекер і під'єднайте зарядний пристрій.

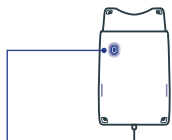
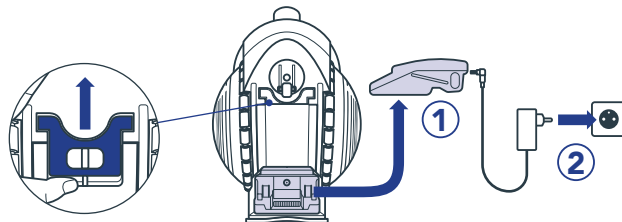

Світиться синій індикатор: батарея заряджається.

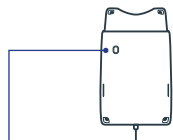

Синій індикатор не світиться: акумулятор заряджений.

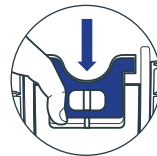
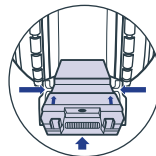

Скануйте, щоб дізнатися більше про акумулятор та його зарядження.



СТАН АКУМУЛЯТОРА

На приладі відображається рівень заряду:

- світяться 3 синіх світлодіодних індикатори: заряджено на 100%.
- світяться 2 синіх світлодіодних індикатори: заряджено на 60%.
- блимає 1 синій світлодіодний індикатор: прилад потрібно зарядити.

Якщо акумулятор повністю розряджений, 1 синій світлодіодний індикатор блиматиме кілька разів.

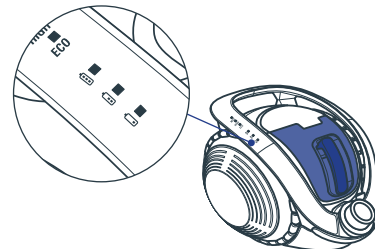

ФУНКЦІЯ FLEX

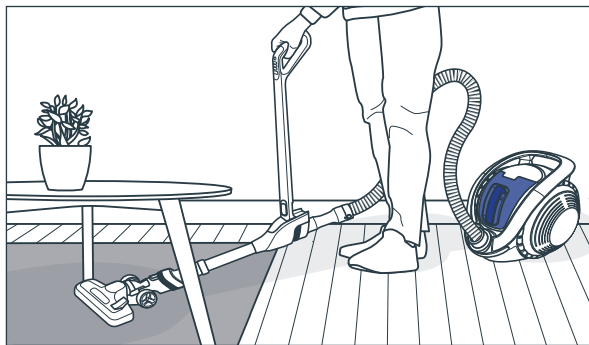

Прилад обладнано технологією Flex. Він дозволяє легко досягти найвіддаленіших місць під низькими меблями. Щоб активувати її, посуньте кнопку Flex угору.

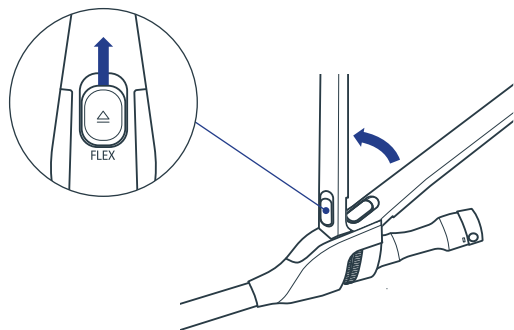

АКСЕСУАРИ

Пристрій має 2 вбудовані щітки Easy Dusting для видалення пилу. Ви можете використовувати їх, щоб обробляти пилососом більшість поверхнь.

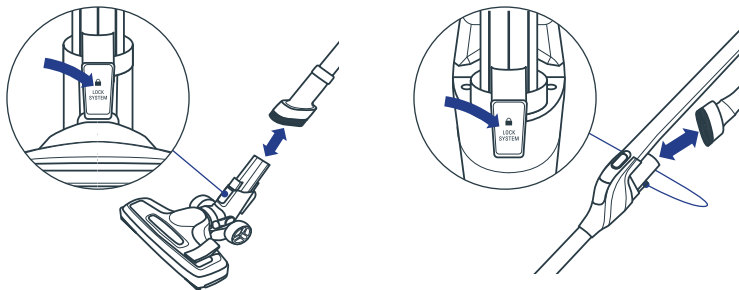

Для чищення окремих ділянок використовуйте додаткові аксесуари: вставляйте їх в одну з трубок на максимальну глибину.

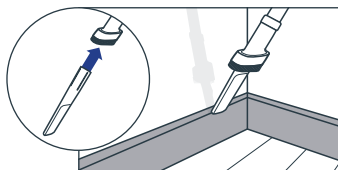

Використовуйте щілинну насадку, щоб пилососити у важкодоступних місцях.

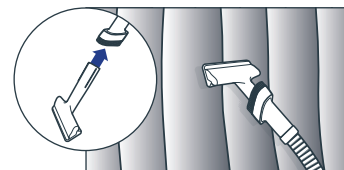

Використовуйте **щітку для диванів** для чищення текстильних виробів, наприклад дивана, штору або матраца.

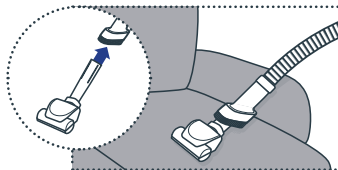

Використовуйте **мінітурбощітки в режимі MAX (МАКС.) або BOOST (ТУРБО) для ретельної обробки диванів, матраців або килимів в автомобілі.



ОБСЛУГОВУВАННЯ

Скануйте за допомогою телефону або пристрою для зчитування QR-кодів, щоб максимально ефективно використовувати поради з обслуговування для найкращої продуктивності роботи приладу.



СПОРОЖНЕННЯ ПИЛОЗБІРНИКА

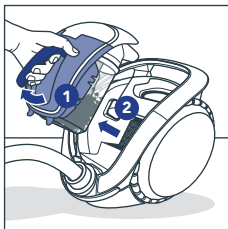
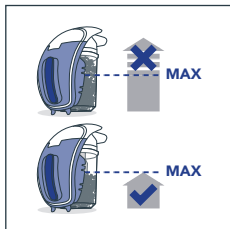

ОБСЛУГОВУВАННЯ ЦИКЛОННОГО ФІЛЬТРА

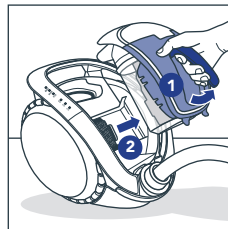
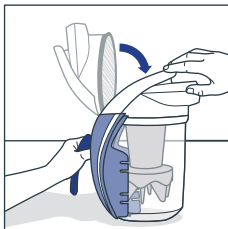
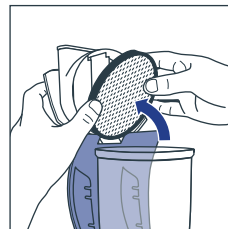
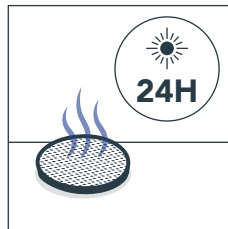
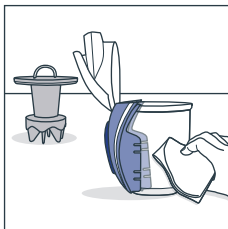
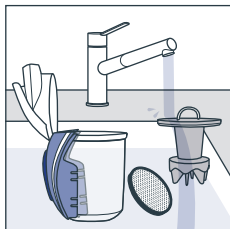

Промивайте циклонний фільтр водою після кожного спорожнення пилозбірника. Замінюйте його раз на рік. Щоб придбати новий, шукайте посилання Rowenta ZR007700.

ОБСЛУГОВУВАННЯ ФІЛЬТРА ДВИГУНА



РАЗ НА
МІСЯЦЬ

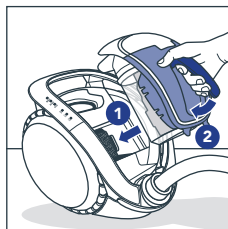
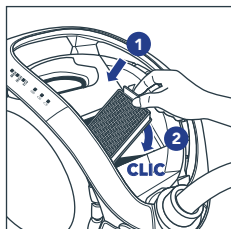
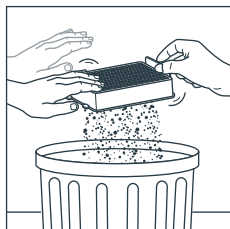
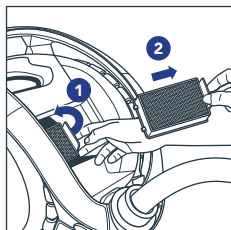
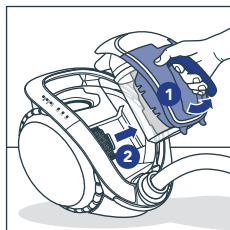

РАЗ НА
РІК

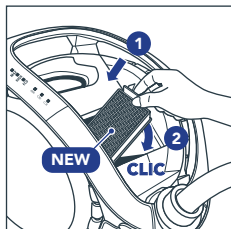
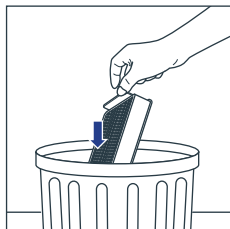

Заміняйте фільтр двигуна один раз на рік.

Щоб придбати новий, шукайте посилання Rowenta ZR007700.

ЧИЩЕННЯ МІНІТУРБОЩІТКИ

Перед чищенням завжди знімайте аксесуар мінітурбощітки (доступно в деяких моделях).

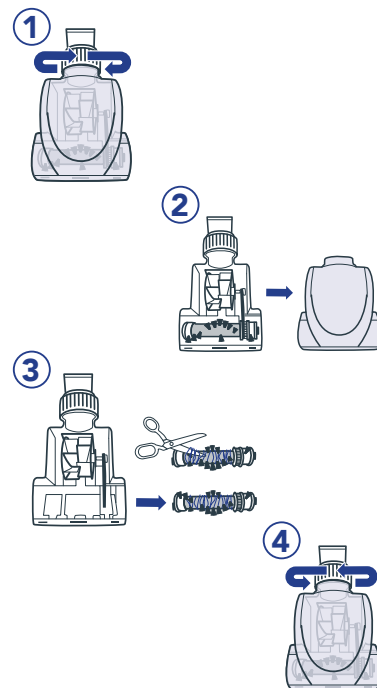

ЗБЕРІГАННЯ

ВАРІАНТ 1

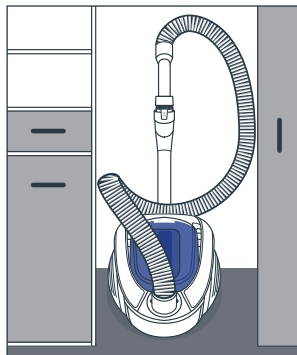
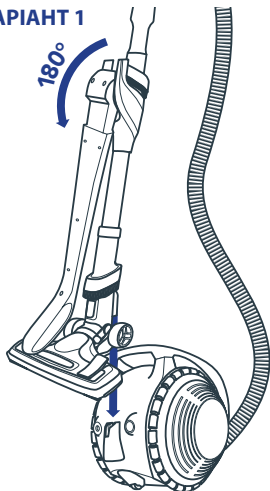

ВАРІАНТ 2

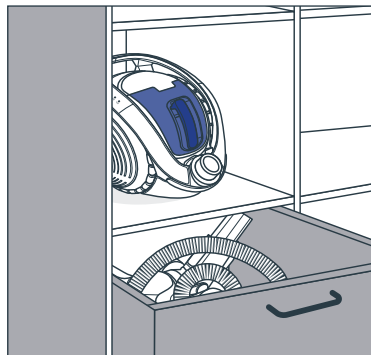
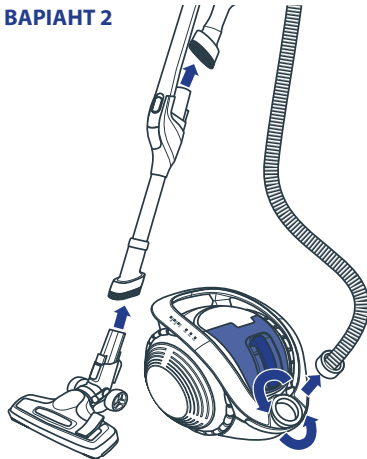

ПОПЕРЕДЖЕННЯ

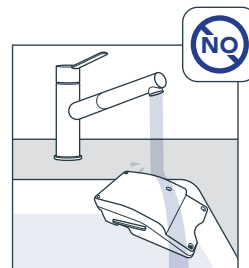
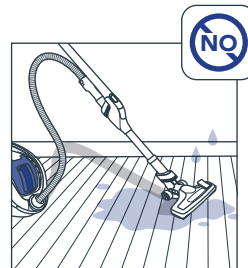

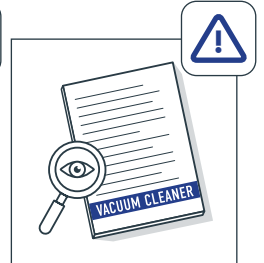
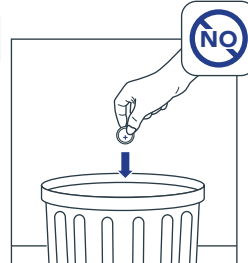
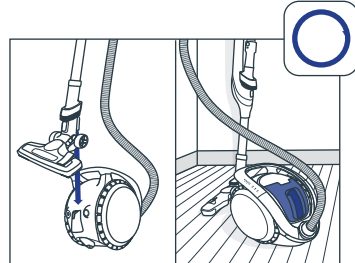
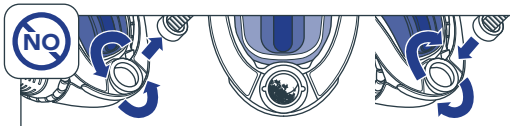
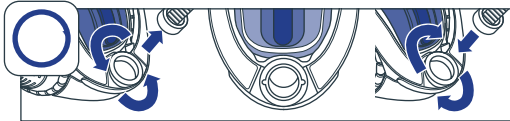
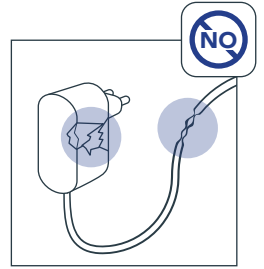
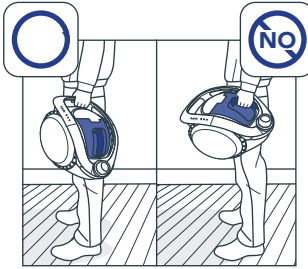
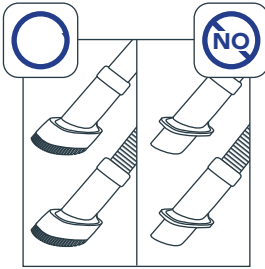
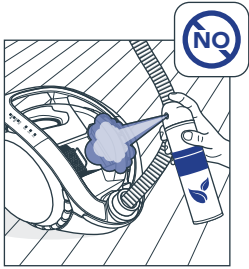
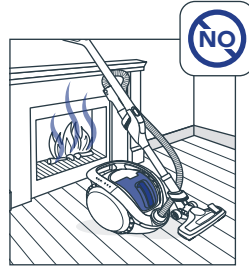
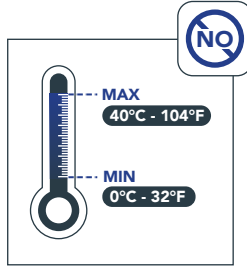



Děkujeme, že jste si vybrali model Rowenta X-Ö.

Váš spotřebič je vybaven nejnovější technologií společnosti Rowenta.

Pečlivě si přečtěte tuto příručku, abyste mohli svůj spotřebič využít naplno.

Oskenujte fotoaparátem v mobilu nebo QR čtečkou a podívejte se na užitečného videoprůvodce sestavením spotřebiče.



SESTAVENÍ



Varování! Před prvním použitím si přečtěte stranu 86.

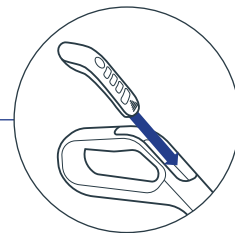
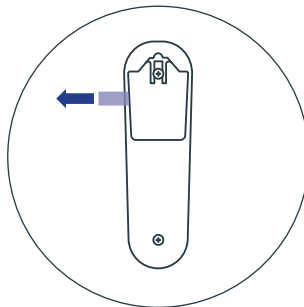

PŘED PRVNÍM POUŽITÍM JE TŘEBA PLNĚ NABÍT BATERII

Před zapojením do zásuvky připojte konektor.

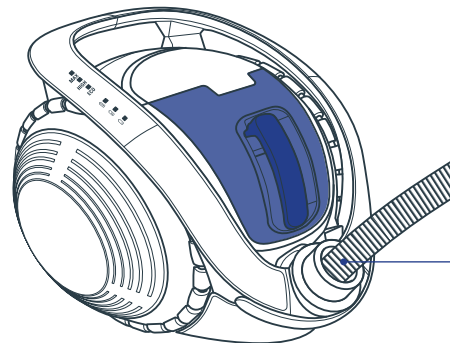
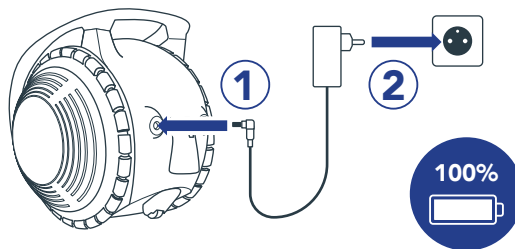

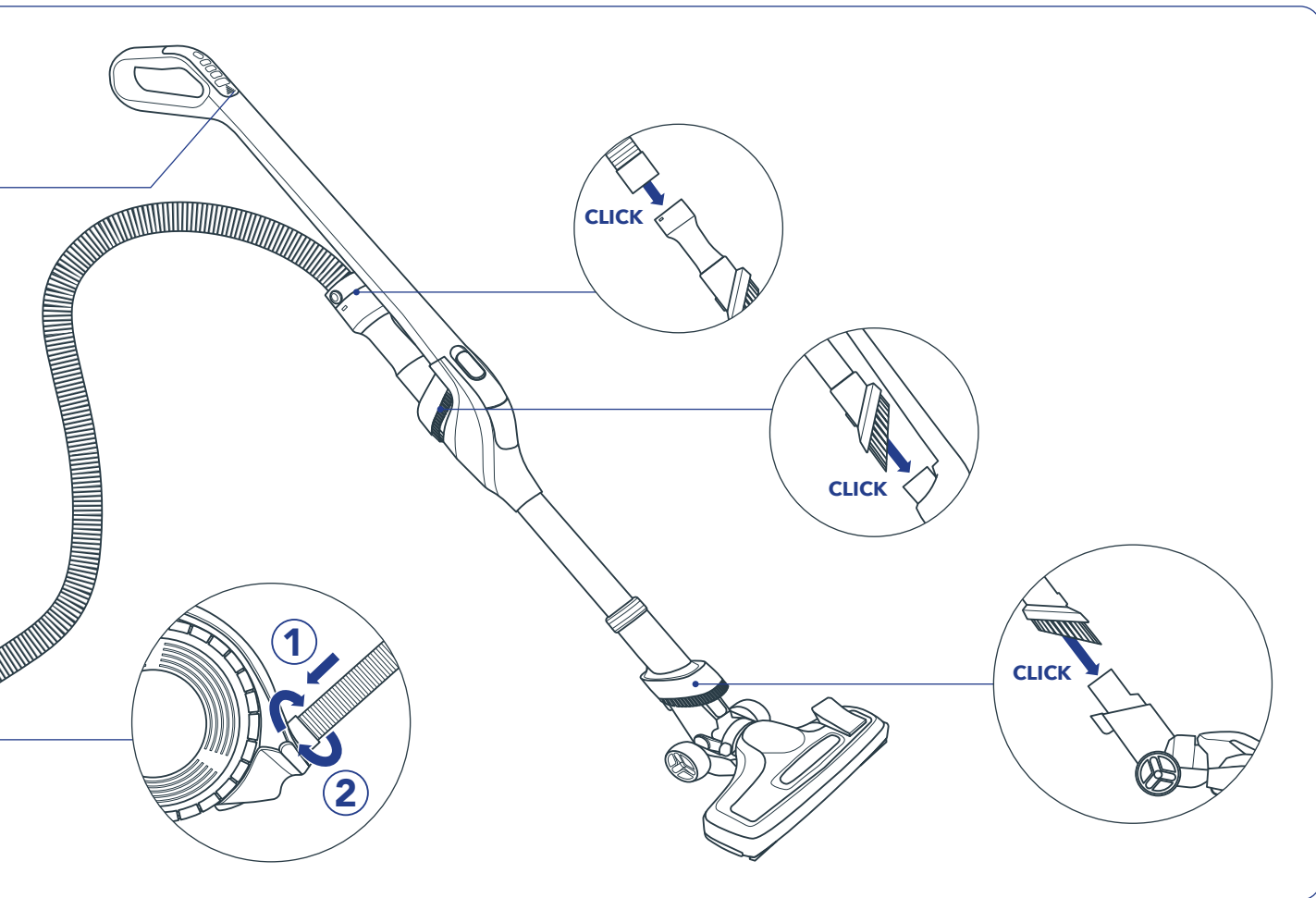

PŘED PRVNÍM POUŽITÍM



Jak spárovat
dálkové ovládání?



Před prvním použitím spárujte dálkové ovládání.

Je třeba provést pouze jednou.

	Co je třeba udělat:	Co uvidíte na spotřebiči:
1	Před prvním použitím vyjměte plastový jazyček.	
2	Zapnout spotřebič: Stiskněte tlačítko Zap./Vyp.	Rozsvítí se modré LED kontrolky baterie.
3.1	Spustit párování: Stiskněte současně tlačítka MAX a II .	- Uslyšíte potvrzovací pípnutí. - Modré LED kontrolky baterie a zelené LED ukazatele rychlosti začnou střídavě blikat.
3.2	Potvrdit párování: Okamžitě po kroku 3.1 stiskněte tlačítko II . (zatímco kontrolky LED střídavě blikají)	- Modré kontrolky LED budou dále svítit. - Ozvou se dvě pípnutí. Pokud do 10 sekund neproslyšíte dvě pípnutí, párování se nezdařilo. Vypněte spotřebič a začněte znovu od kroku 2.

► Blahopřejeme! Úspěšně jste spárovali dálkové ovládání.

TLAČÍTKO ZAP./VYP.

Pokud chcete spotřebič zapnout či vypnout, krátce stiskněte tlačítko Zap./Vyp. Pokud chcete začít vysávat, zvolte na ovladači možnosti ECO, HIGH nebo MAX.

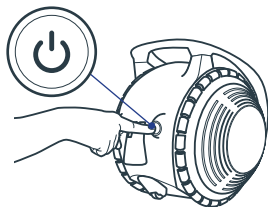

REŽIMY VYSÁVÁNÍ

Přístroj má 4 režimy vysávání. Tlačítka na dálkovém ovládání můžete měnit režimy a nastavovat jejich sílu:

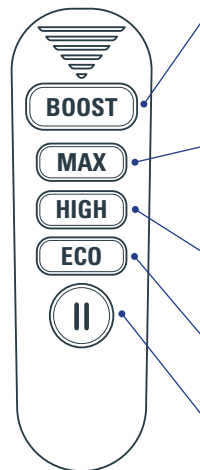

BOOST: 5/10 min*

Intenzivní vysávání odolné špíny.

Poznámka: Pokud chcete tento režim používat, nepřetržitě držte tlačítko BOOST.

MAX: 20/40 min*

Intenzivní vysávání a usazený prach. Hodí se pro všechny typy koberců.

HIGH: 40/50/90 MIN*

Pro běžný úklid. Hodí se pro všechny typy tvrdých podlah.

ECO: 1h 10 min / 1h 30 min / 2h 40 min*

Pro mírně znečištěné podlahy a jemné povrchy (police, rámy, závěsy atd.)

PAUZA:

Dočasné vypnutí během vysávání.

Kontrolky LED ukazují režimy. V režimu BOOST budou všechny tři zelené kontrolky blikat současně.

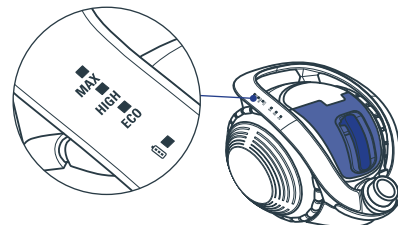

*v závislosti na modelu.

SACÍ HUBICE

Vaše 2polohová hubice je vybavena pedálem, který umožňuje měnit mezi nastavením na koberec a na tvrdou podlahu.

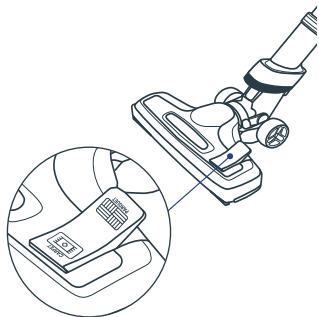

PARKETY

Nastavení na tvrdé podlahy, vhodné na dřevěné parkety, dlažbu, linoleum atd.



KOBERCE

Nastavení na koberec, ideální pro hloubkové vysávání koberců i rohoží.

DÁLKOVÉ OVLÁDÁNÍ

Přístroj je řízen dálkovým ovládáním, které se nachází v rukojeti. Je napájeno kulatou baterií typu CR2032.

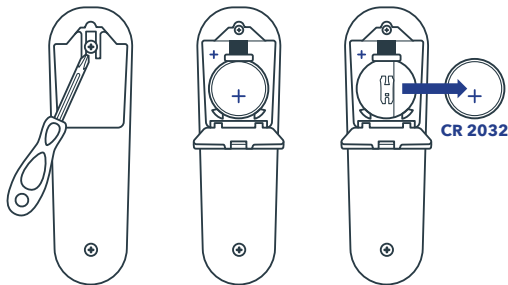

Doporučujeme baterii vyměnit každých 18 měsíců.

V případě ztráty nebo poškození dálkového ovládání můžete přístroj zapnout dlouhým stisknutím tlačítka ON.

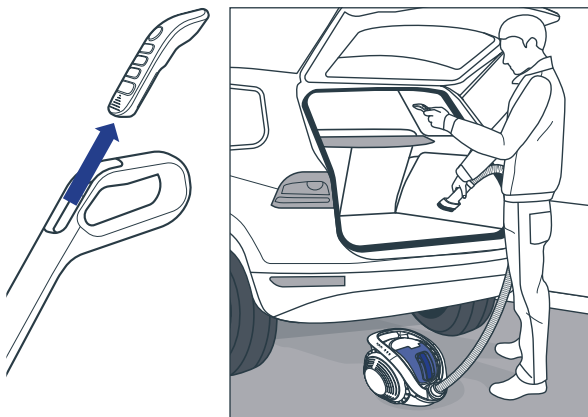

Dálkové ovládání můžete od vysavače oddělit a vysávat pouze s pomocí pružné hadice (tato možnost je ideální například pro čištění auta).

Jak používat dálkové ovládání?



BATERIE A NABÍJENÍ



PLNÉ NABÍTÍ BATERIE TRVÁ 4 HODINY.

Pokud chcete spotřebič nabít, máte na výběr ze dvou možností:

MOŽNOST 1

Připojte nabíječku přímo k vysavači: nejdříve připojte konektor a až pak zapojte do zásuvky.

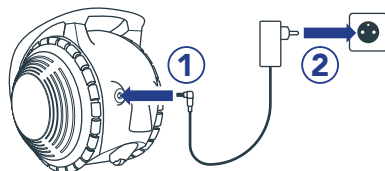

MOŽNOST 2

Zapojte baterii do nabíječky. Vyjměte baterii ze spotřebiče, připojte konektor a až pak zapojte do zásuvky.

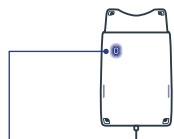
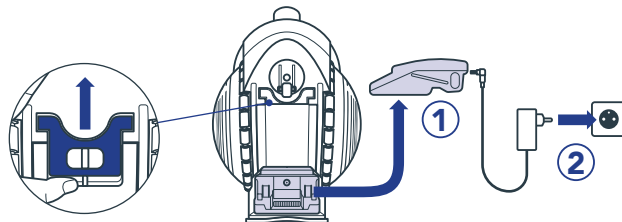

Modrá kontrolka svítí:
baterie se nabíjí.

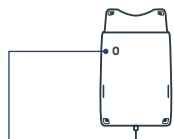

Modrá kontrolka nesvítí:
baterie je nabitá.

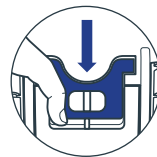
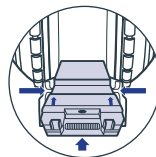

Naskenujte kód a zjistíte více
o baterii a jejím nabíjení.



STAV BATERIE

Váš spotřebič indikuje úroveň nabití:

- Svítí 3 modré kontrolky LED: Baterie je nabitá na 100 %.
- Svítí 2 modré kontrolky LED: Baterie je nabitá na 60 %.
- Bliká 1 modrá kontrolka LED: vysavač je třeba dobít.

Pokud se baterie zcela vybita, 1 modrá kontrolka LED několikrát blikne.

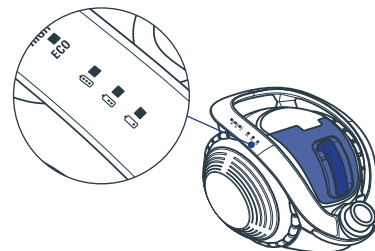

FUNKCE FLEX

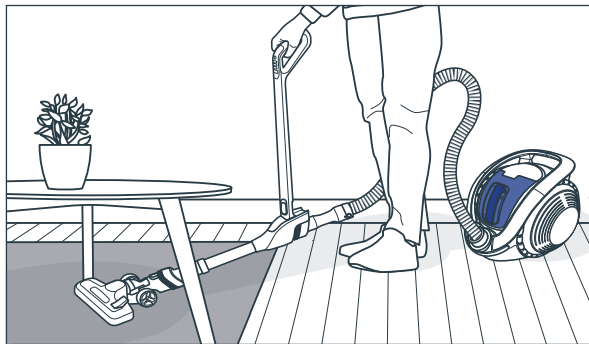

Váš vysavač je vybaven technologií Flex. Díky ní bez námahy uklidíte i pod nízkým nábytkem. Pokud ji chcete aktivovat, posuňte tlačítko Flex nahoru.

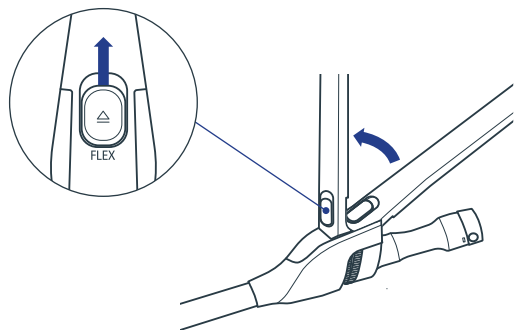

PŘÍSLUŠENSTVÍ

Váš spotřebič je vybaven 2 zabudovanými kartáči na prach. Ty lze použít k vysávání většiny povrchů.

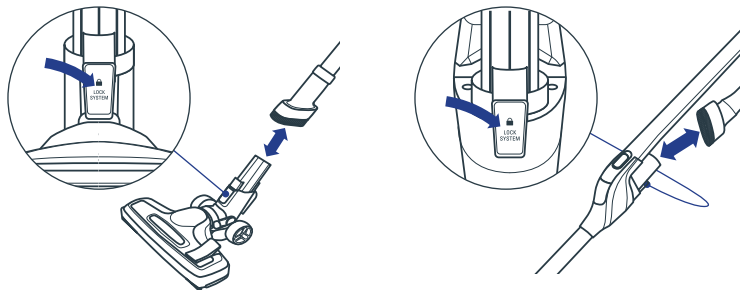

Pro úklid speciálních oblastí použijte další příslušenství – zasuněte je do maximální hloubky do jedné z trubek vysavače.

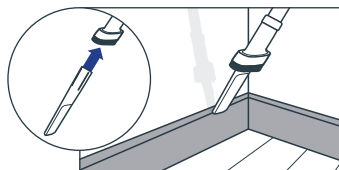

Štěrbínovou hubici použijte k vysávání těžko dostupných míst.

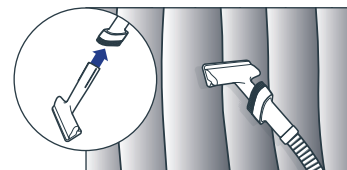

Kartáč na pohovky použijte k vysávání textilií, jako je pohovka, záclony nebo matrace.

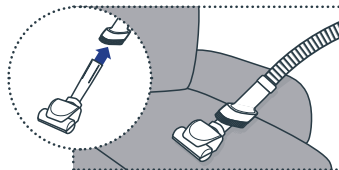

****Mini turbokartáč** použijte v režimu MAX nebo BOOST pro hloubkové vysávání gaučů, matrací nebo rohoží do auta.

***k dispozici pouze u některých modelů.*

X-Ô

ÚDRŽBA

O skenujte fotoaparátém v mobilu nebo QR čtečkou a získáte užitečné rady pro údržbu, abyste mohli využít svůj spotřebič naplno.



VYPRÁZDNĚNÍ NÁDOBY NA PRACH

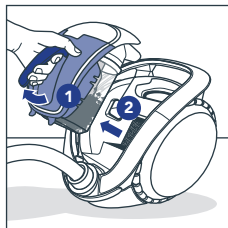
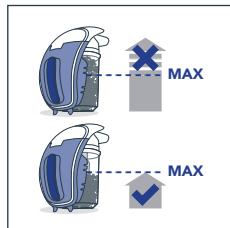

ÚDRŽBA CYKLONOVÉHO FILTRU

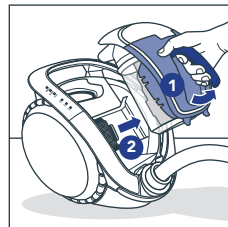
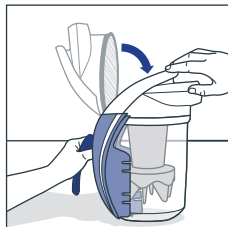
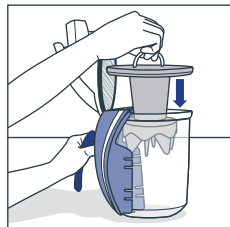
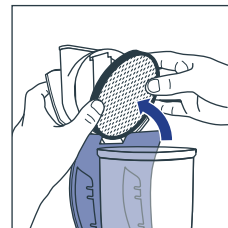
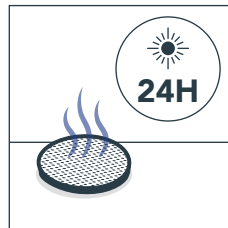
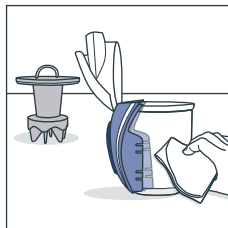
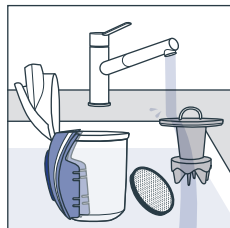

Po každém vyprázdnění nádoby na prach umyjte filtr ve vodě. Jednou ročně ho vyměňte. Pokud chcete koupit nový, orientujte se podle modelu Rowenta ZR007700.

ÚDRŽBA FILTRU MOTORU

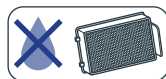

1x
ZA MĚSÍC

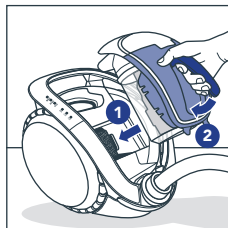
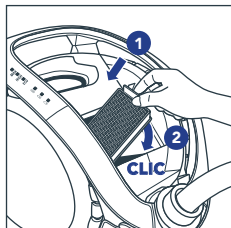
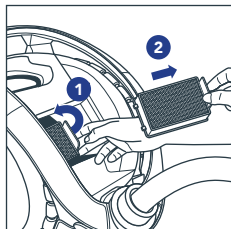
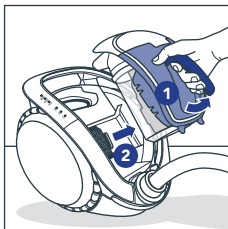

1x
ZA ROK

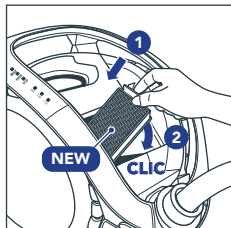
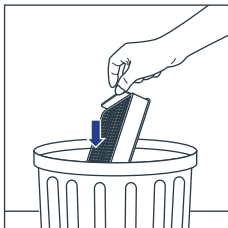

Filtr motoru vyměňte jednou ročně.

Pokud chcete koupit nový, orientujte se podle modelu Rowenta ZR007700.

ČIŠTĚNÍ MINI TURBOKARTÁČE

Před čištěním vždy mini turbokartáč vyjměte (k dispozici pouze u některých modelů).

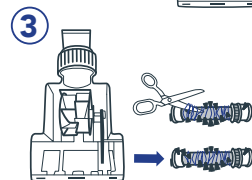
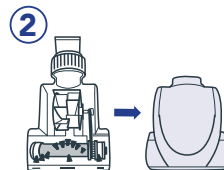

SKLADOVÁNÍ

MOŽNOST 1

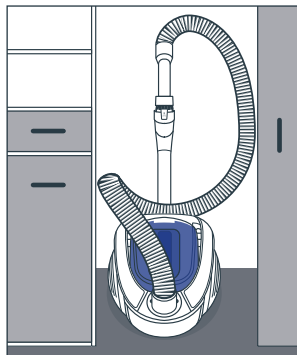
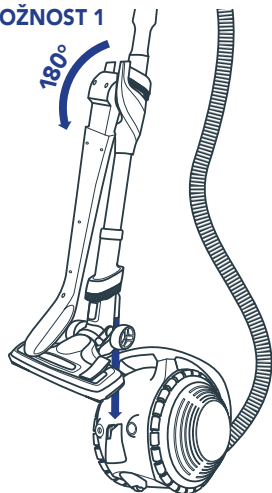

MOŽNOST 2

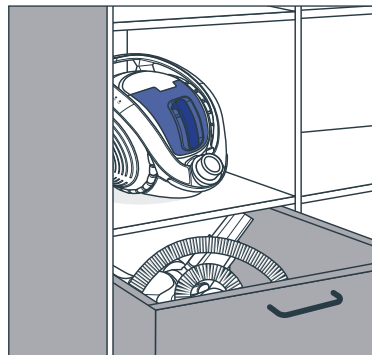
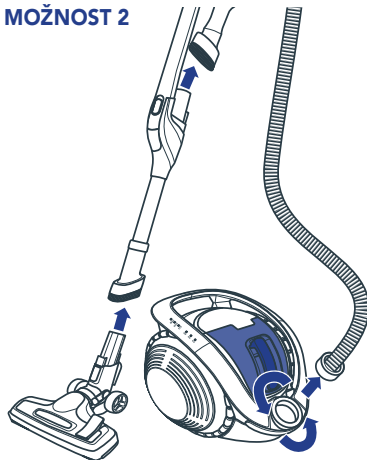

VAROVÁNÍ

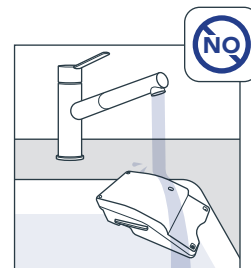
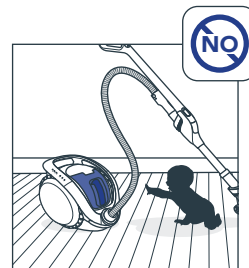

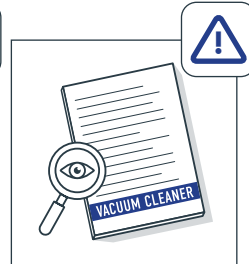
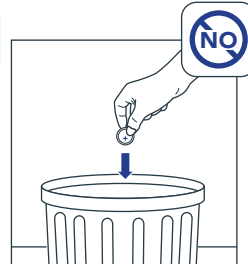
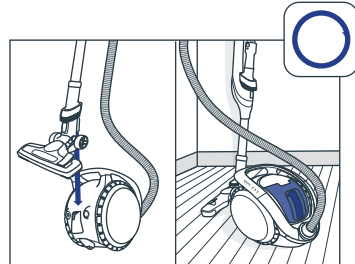
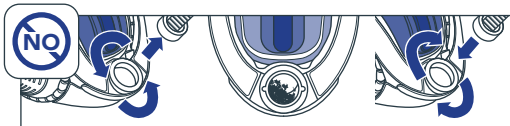
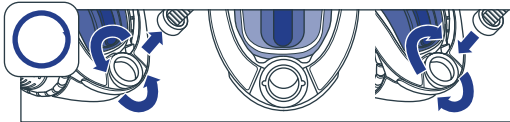
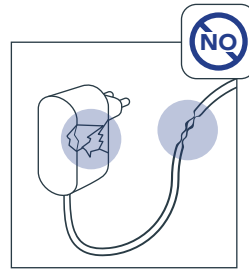
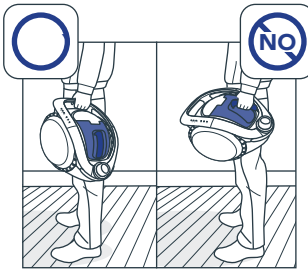
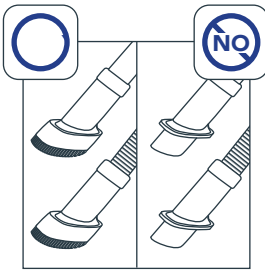
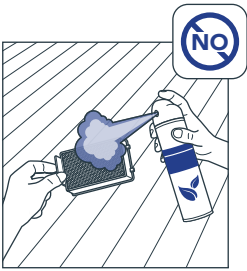
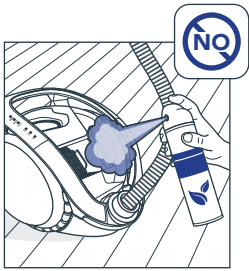
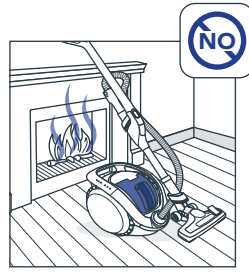
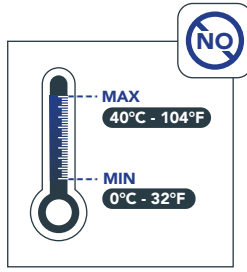



Ďakujeme vám, že ste sa rozhodli kúpiť vysávač Rowenta X-Ö. Váš spotrebič disponuje najnovšími technológiami od spoločnosti Rowenta.

Prečítajte si pozorne tento návod, aby ste zo schopností svojho spotrebiča vyťažili čo najviac.

Naskenujte pomocou fotoaparátu svojho telefónu alebo čítačky kódov QR a pozrite si užitočný videonávod na zmontovanie svojho spotrebiča.



ZMONTOVANIE



Varovanie! Pred prvým použitím je potrebné vykonať opatrenie. Pozrite si stranu 96.

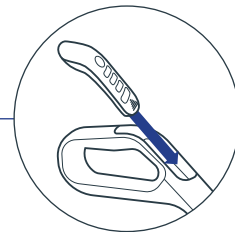
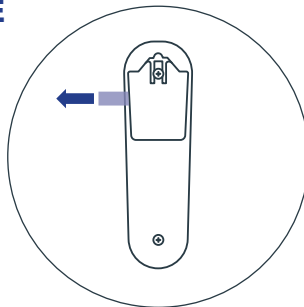

PRED PRVÝM POUŽITÍM MUSÍTE SPOTREBIČ ÚPLNE NABIŤ

Najprv zapojte konektor jack a až potom spotrebič zapojte do siete.

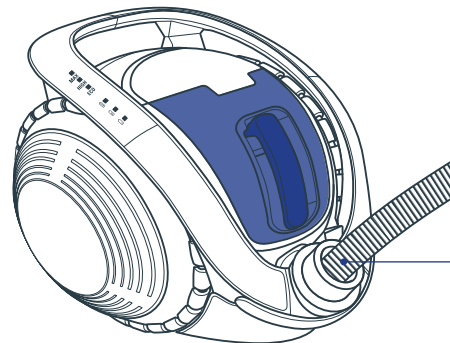
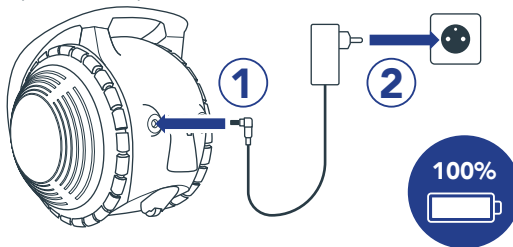

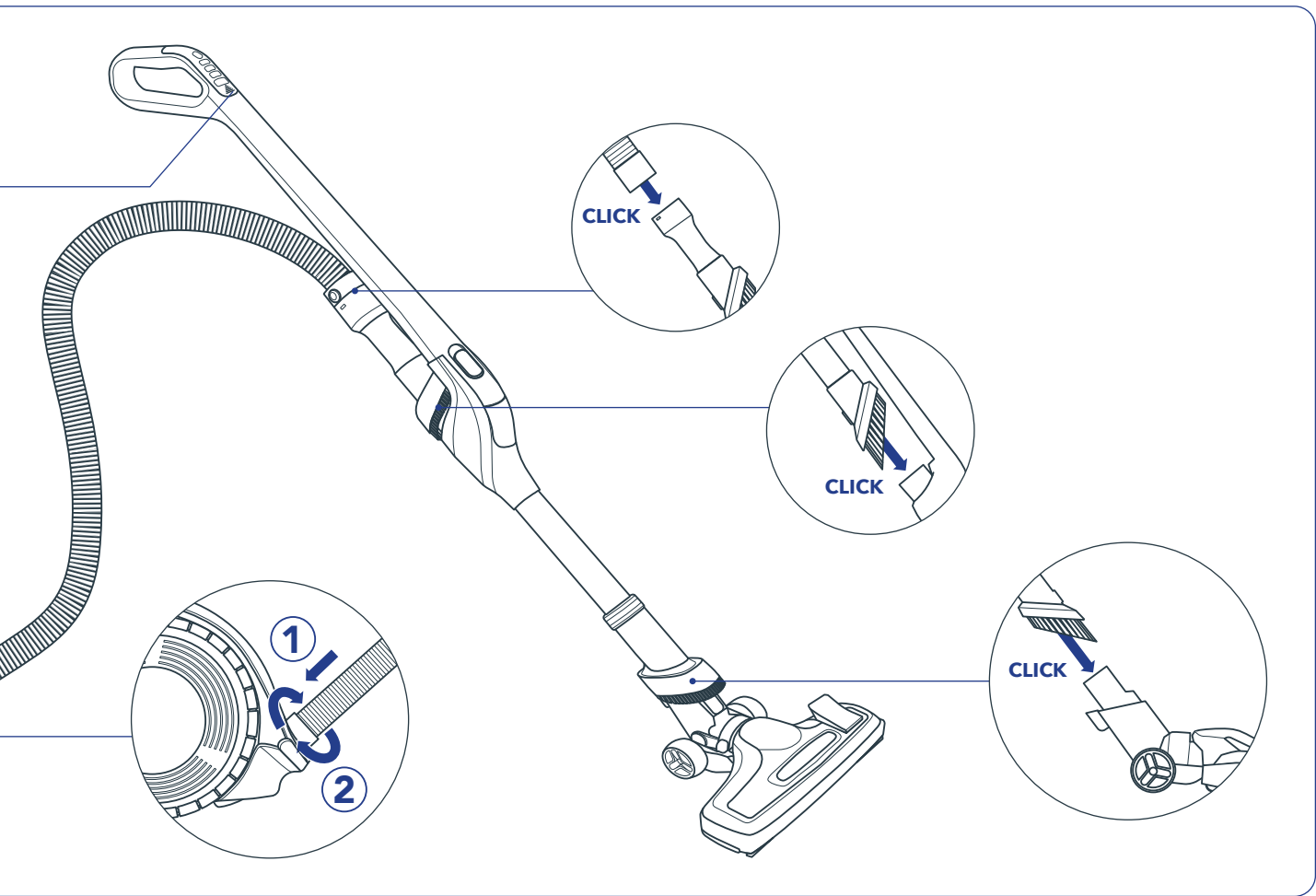

PRED PRVÝM POUŽITÍM



Ako spárujem moje diaľkové ovládanie?



Pred prvým použitím spárujte spotrebič s diaľkovým ovládaním.

Tento krok stačí vykonať iba raz.

	Budete potrebovať:	Čo vidíte na svojom spotrebiči:
1	Pred prvým použitím odstráňte plastový štítok.	
2	Zapnite spotrebič: Stlačte vypínač.	Rozsvietia sa modré indikatory LED batérie.
3.1	Spustíte proces párovania: Súčasne stlačte tlačidlá MAX a II .	- Zaznie potvrdzujúce pípnutie - Modré indikatory LED batérie a zelené indikatory LED otáčok striedavo blikajú
3.2	Potvrďte spárovanie: Po kroku 3.1 okamžite stlačte tlačidlo II . (kým indikatory LED striedavo blikajú)	- Modré indikatory LED zostanú svietiť - Zaznie dvojité pípnutie Ak po 10 sekundách nezaznie dvojité pípnutie: nepodarilo sa spárovať. Vypnite spotrebič a začnite znova od kroku 2.

➤ **Blahoželáme! Úspešne ste spárovali svoje diaľkové ovládanie.**

ZAPNUTIE/VYPNUTIE TLAČIDLA NAPÁJANIA

Ak chcete spotrebič zapnúť alebo vypnúť, krátko stlačte tlačidlo napájania.

Ak chcete spustiť vysávanie, stlačte tlačidlo otáčok ECO, HIGH alebo MAX na diaľkovom ovládaní.

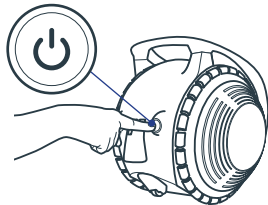

REŽIM VÝKONU

Spotrebič má 4 režimy výkonu. Pomocou diaľkového ovládania môžete meniť režimy vysávania a nastaviť výkon:

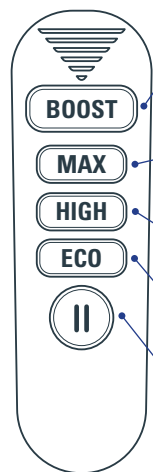

BOOST: 5min/10min*

Intenzívne vysávanie podlahy, ktorá je veľmi znečistená prachom.

Upozornenie: Na používanie tohto režimu držte tlačidlo BOOST stlačené.

MAX: 20/40min*

Intenzívne vysávanie podlahy znečistenej prachom. Ideálne na všetky druhy kobercov.

HIGH: 40/50/90MIN*

Na vysávanie na zachovanie poriadku. Ideálne na všetky druhy tvrdých podláh.

ECO: 1h10/1h30/2h40min*

Na mierne znečistené podlahy a jemné povrchy: police, rámy, záclony atď.

PAUSE (Pozastaviť):

Dočasné vypnutie počas používania.

Indikatory LED indikujú režimy výkonu.

V režime BOOST budú súčasne blikáť všetky tri zelené indikatory.

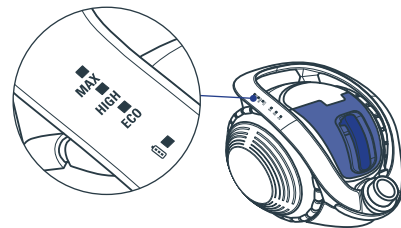

*v závislosti od modelu.

SACIA HUBICA

2-polohová hubica je vybavená pedálovým prepínačom, ktorý umožňuje prepínať medzi polohou na koberce a polohou na tvrdé podlahy.

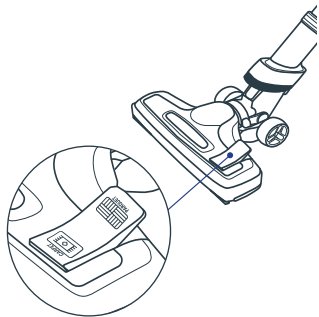

PARQUET (PARKETY)

Poloha na tvrdé podlahy, ktorá je kompatibilná s drevenými parketami, dlažbou, linoleom atď.



CARPET (KOBRECE)

Poloha na koberce, ktorá je ideálna na hĺbkové vysávanie kobercov alebo behúňov.

DIAĽKOVÉ OVLÁDANIE

Váš spotrebič sa ovláda diaľkovým ovládaním, ktoré je integrované v rukoväti. Je napájané okrúhlu batériou typu CR2032.

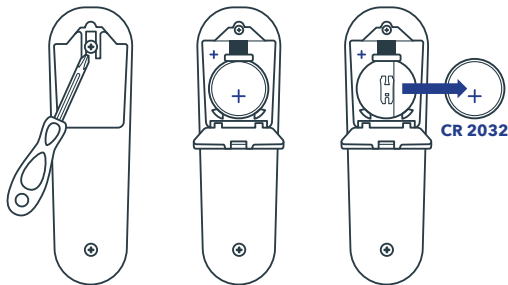

Odporúčame vám meniť batériu každých 18 mesiacov.

V prípade straty alebo poškodenia diaľkového ovládania môžete aj naďalej zapínať napájanie spotrebiča dlhým stlačením vypínača.

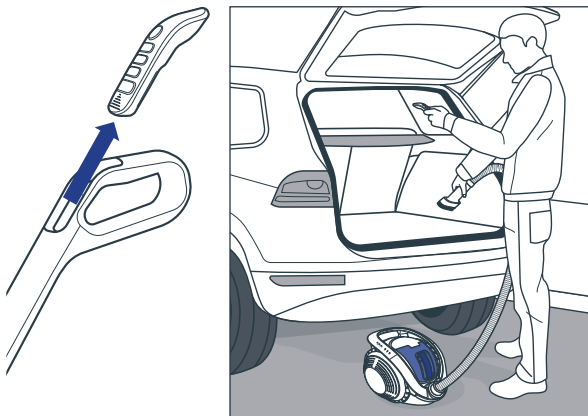

Diaľkové ovládanie môžete odpojiť a vysávať len pomocou flexibilnej hadice (ideálne napríklad na vysávanie auta).

Ako používať
diaľkové ovládanie?



BATÉRIA A NABÍJANIE



ÚPLNÉ NABITIE BATÉRIE TRVÁ 4 HODINY.

Ak chcete nabiť spotrebič, máte na výber z dvoch možností:

MOŽNOSŤ 1

Pripojte nabíjačku priamo k vysávaču: najprv vložte konektor jack a následne zapojte spotrebič do elektrickej zásuvky.

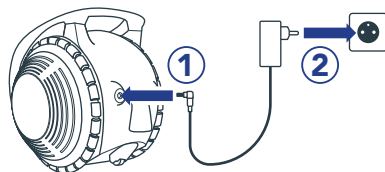

MOŽNOSŤ 2

Pripojte nabíjačku k batérii. Ak chcete tak urobiť, vyberte batériu zo spotrebiča, vložte konektor jack a potom pripojte nabíjačku.

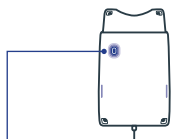
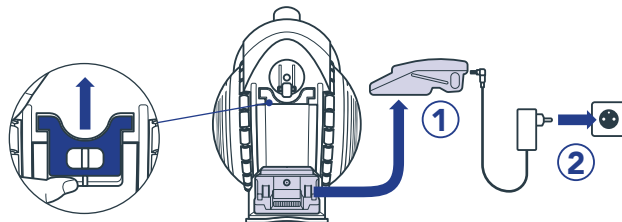

Svieti modrý indikátor:
batéria sa nabíja.

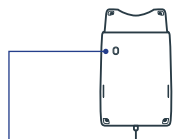

Modrý indikátor
nesvieti: batéria je
nabitá.

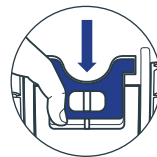
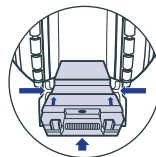

Naskenujte a zistite ďalšie
informácie o batérii a jej nabíjaní.



STAV BATÉRIE

Spotrebič indikuje úroveň nabitia nasledovne:

- svietia 3 modré indikátory LED:
Nabité na 100%.
- svietia 2 modré indikátory LED:
Nabité na 60%.
- bliká 1 modrý indikátor LED:
spotrebič je potrebné znovu nabiť.

Ak je batéria úplne vybitá, 1 modrý indikátor LED niekoľkokrát blikne.

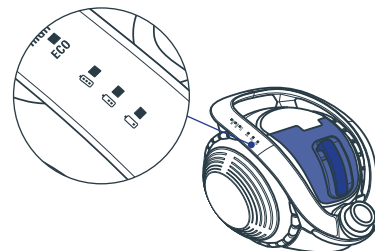

FUNKCIA FLEX

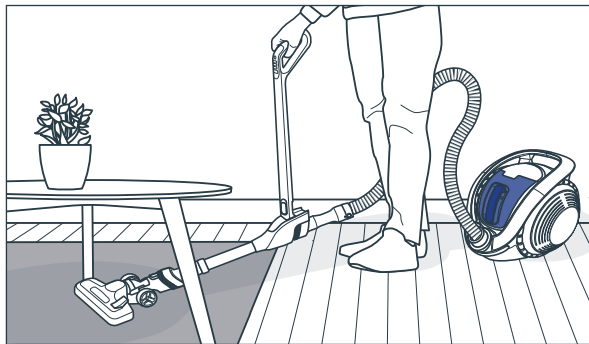

Váš spotrebič je vybavený technológiou Flex. Umožňuje bez námahy dosiahnuť na najvzdialenejšie miesta pod nábytkom, ktorého spodná časť sa nachádza nízko nad podlahou.

Ak ju chcete aktivovať, posuňte tlačidlo Flex smerom nahor.

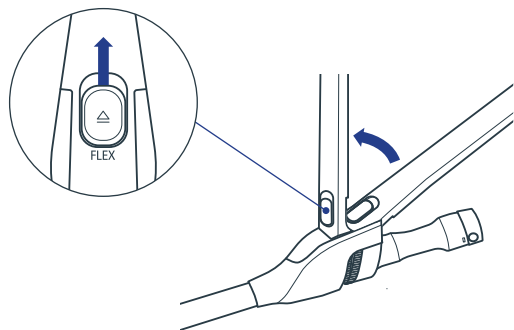

PRÍSLUŠENSTVO

Váš spotrebič má 2 integrované kefy s technológiou Easy Dusting. Môžete ich používať na vysávanie väčšiny povrchov.

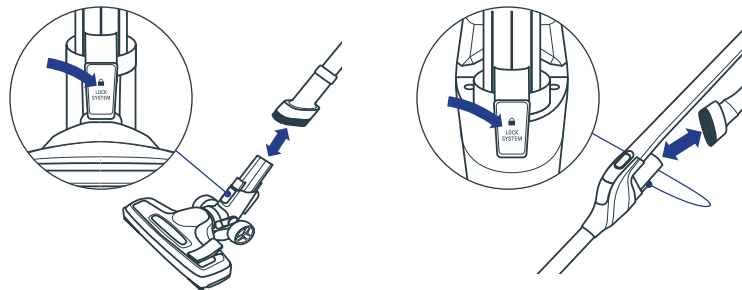

Na čistenie špecifických oblastí použite dodatočné príslušenstvo: vsuňte ho na doraz do jednej z trubic.

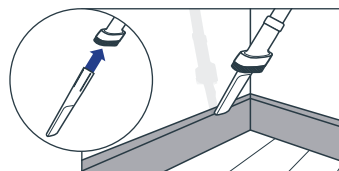

Na vysávanie ťažko dostupných miest použite štrbinový nastavtec.

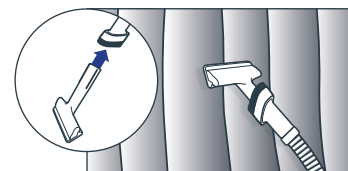

Na vysávanie textilných povrchov, ako je napríklad pohovka, záclony alebo matrace, použite **jemnú kefku**.

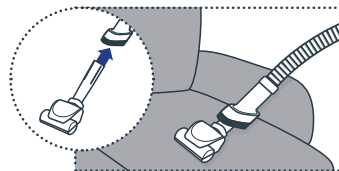

Na hĺbkové vysávanie pohoviek, matracov alebo koberčiek do auta použite **kefku Mini Turbo, prípadne režim MAX alebo BOOST.

X-Ô

ÚDRŽBA

Naskenujte pomocou telefónu alebo čítačky kódov QR, aby ste čo najlepšie využili rady týkajúce sa údržby a dosiahli čo najlepší výkon.



VYPRÁZDNENIE PRACHOVEJ NÁDOBY

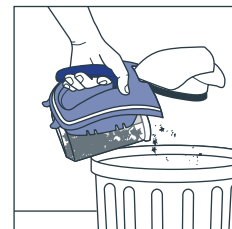
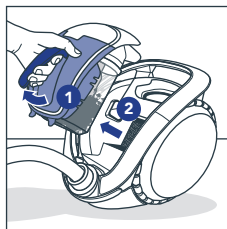
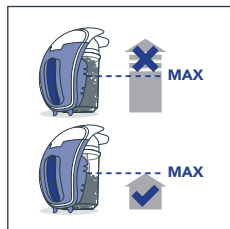

ÚDRŽBA CYKLÓNOVÉHO FILTRA

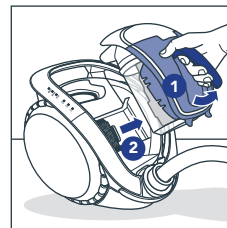
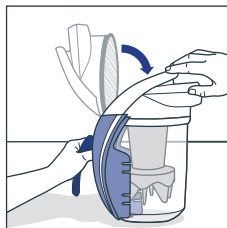
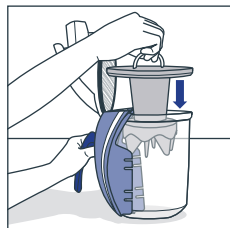
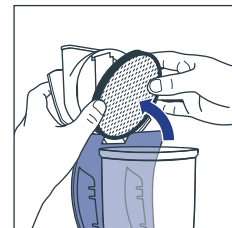
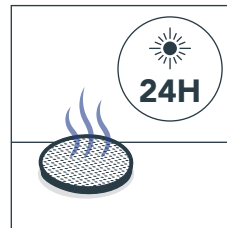
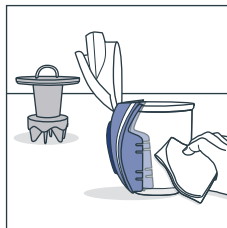
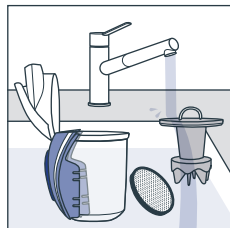

Po každom vyprázdnení prachovej nádoby umyte cyklónový filter vodou. Vymeňte ho raz za rok. Ak si chcete kúpiť nový, hľadajte podľa referencie Rowenta ZR007700.

ÚDRŽBA FILTRA MOTORA



1X
MESAČNE

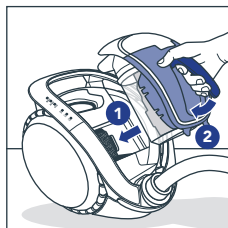
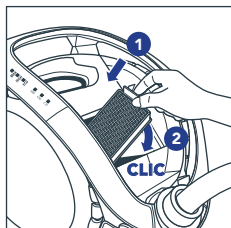
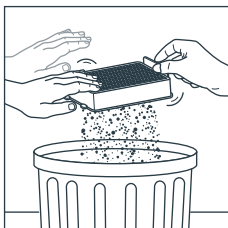
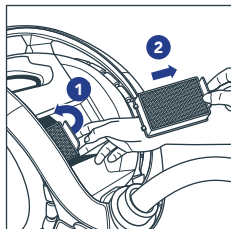
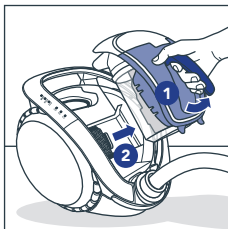

1X
ROČNE

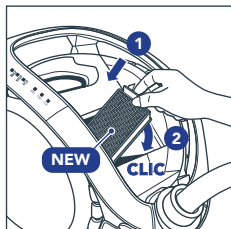
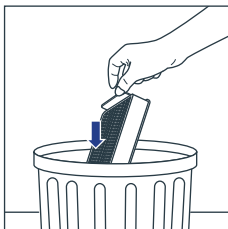

Vymeňte filtre motora raz za rok.

Ak si chcete kúpiť nový, hľadajte podľa referencie Rowenta ZR007700.

ČISTENIE KEFKY MINI TURBO

Pre čistením kefkou Mini Turbo ju vždy odstráňte zo spotrebiča (táto kefka je k dispozícii len pre niektoré modely).

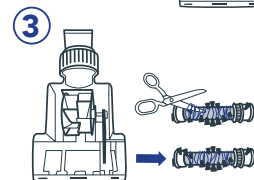
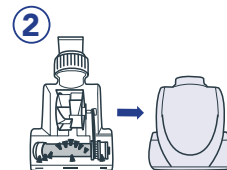

USKLADNENIE

MOŽNOSŤ 1

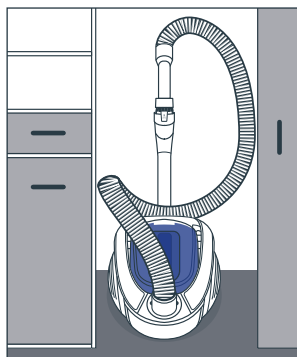
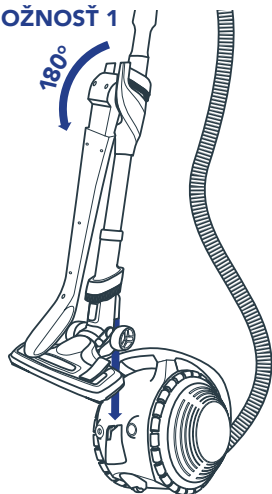

MOŽNOSŤ 2

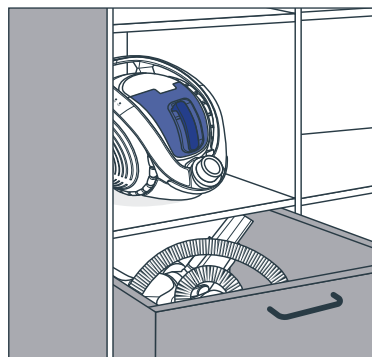
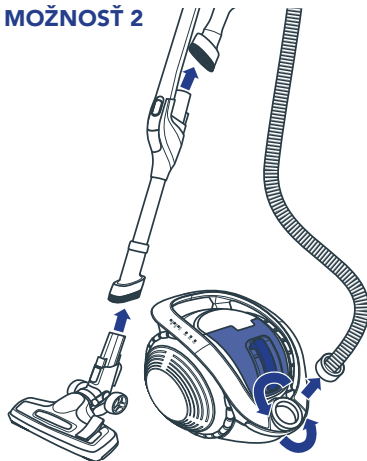

UPOZORNENIE

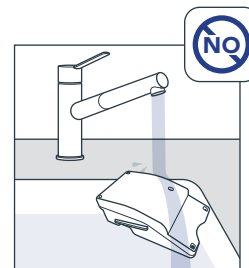
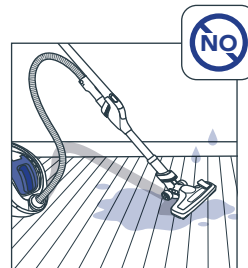

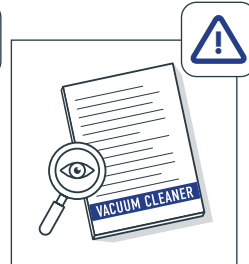
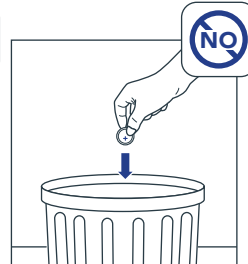
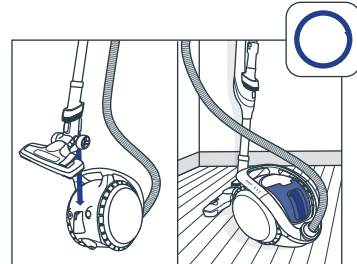
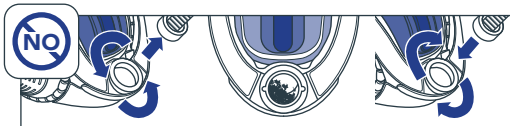
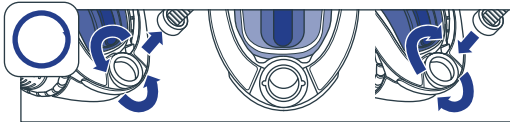
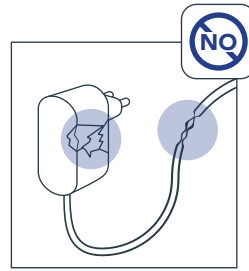
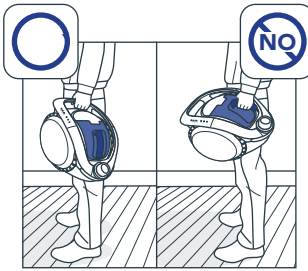
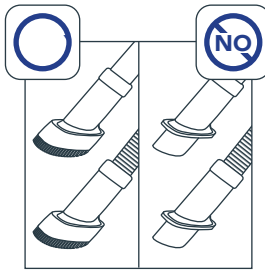
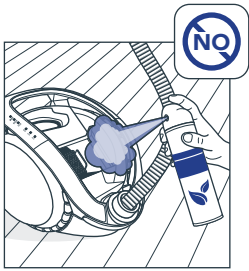
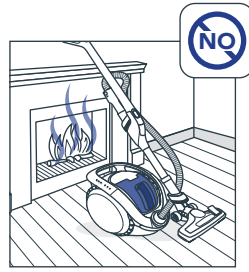
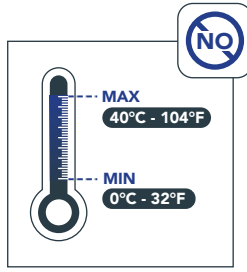



Köszönjük, hogy Rowenta X-Ö terméket választotta.

A készülék a legújabb Rowenta technológiával van felszerelve.

Figyelmesen olvassa el ezt a kézikönyvet, hogy a lehető legtöbb hozhassa ki készülékéből.

Olvassa be a telefonja kamerájával vagy QR-kódolvasójával, hogy megtekinthesse a készülék összeszerelésével kapcsolatos hasznos videós útmutatót.



ÖSSZESZERELÉS



Vigyázat! Az első használat előtt végrehajtandó műveletet lásd a 106. oldalon.

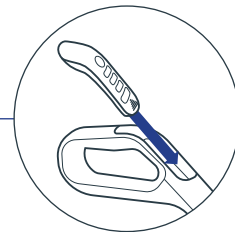
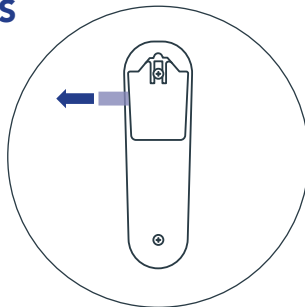

AZ ELSŐ HASZNÁLAT ELŐTT A KÉSZÜLÉKET TELJESEN FEL KELL TÖLTENI

Mielőtt csatlakoztatja a hálózathoz, dugja be a készülékbe a csatlakozót.

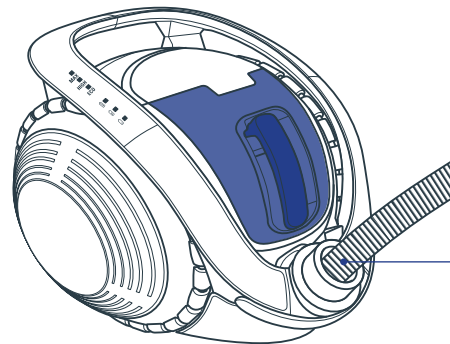
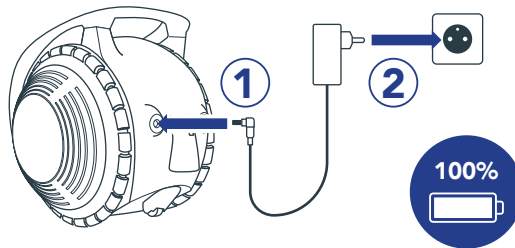

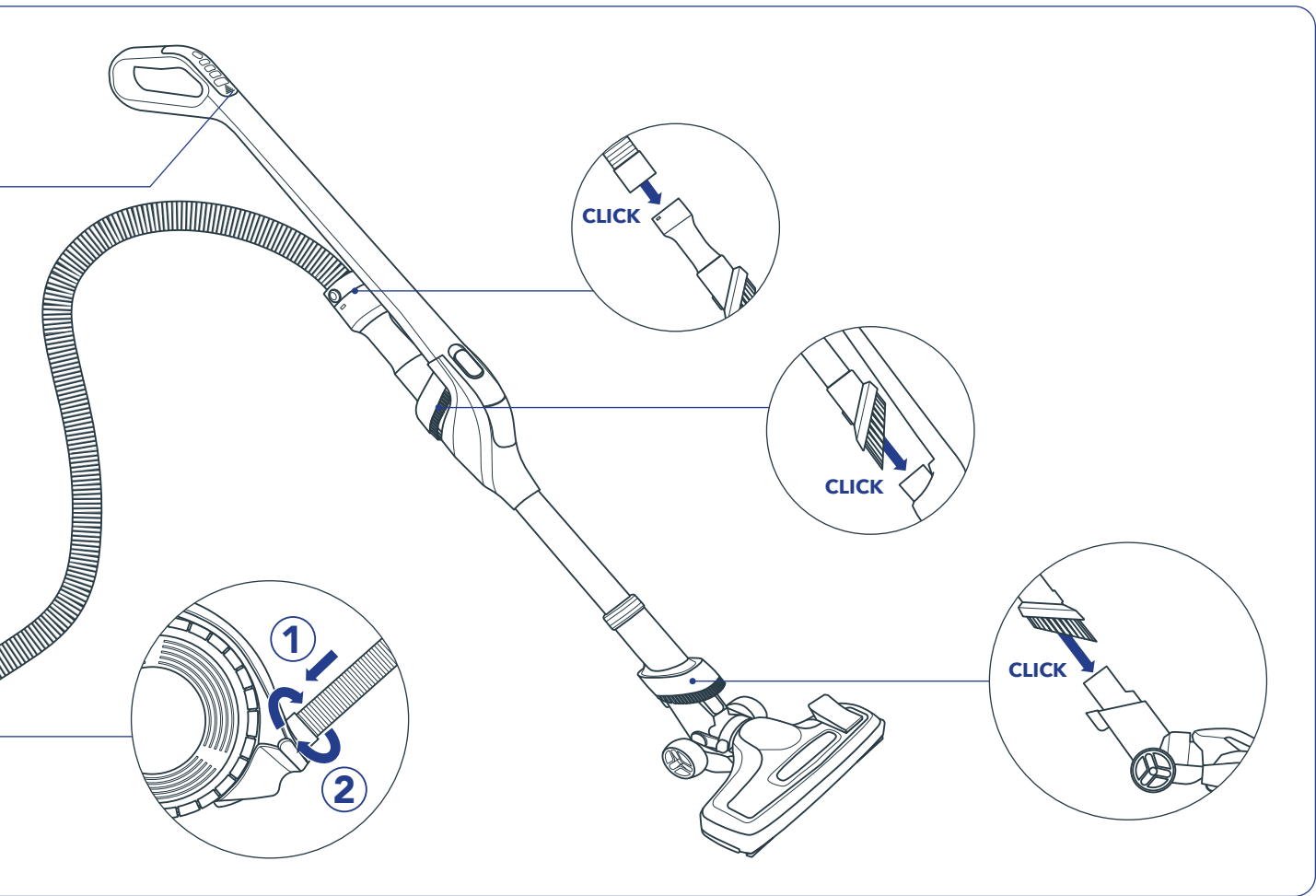

ELSŐ HASZNÁLAT ELŐTT



Hogyan párosíthatom a távirányítót?



Az első használat előtt párosítsa a távirányítót.

Csak egyszer kell elvégezni.

	Amit tennie kell:	Amit lát a készüléken:
1	Az első használat előtt vegye le a műanyag védőfület.	
2	Kapcsolja be a készüléket: Nyomja meg a be-/kikapcsoló gombot.	Az akkumulátor kék LED-jei világítanak.
3.1	Párosítás indítása: Nyomja meg egyszerre a MAX és az II gombot.	- Megerősítő hangjelzés hallható. - Az akkumulátor kék LED-jei és a zöld sebességjelző LED-ek felváltva villognak.
3.2	Párosítás megerősítése: Közvetlenül az a 3.1-es lépés után nyomja meg a II -es gombot. (miközben a LED-ek felváltva villognak).	- A kék LED-ek továbbra is világítanak. - Dupla hangjelzés hallható. Ha 10 másodperc után nem hall két hangjelzést: a párosítás sikertelen volt. Kapcsolja ki a készüléket, és kezdje újra a 2. lépéstől.

➤ Gratulálunk! Sikeresen párosította a távirányítót.

BE-/KIKAPCSOLÓ GOMB

A készülék be- és kikapcsolásához nyomja meg röviden a bekapcsológombot. A porszívózás megkezdéséhez nyomja meg a távvezérlőn az ECO, HIGH vagy MAX gombot.

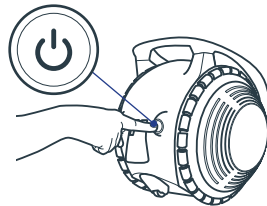

ÜZEMMÓDOK

A készülék négy üzemmóddal rendelkezik. Váltson a tisztítási üzemmódok közül a távirányító gombjaival, és állítsa be a teljesítményt:



BOOST: 5 perc/10 perc*

Intenzív tisztítás lerakódott szennyeződésekhez.

MEGJEGYZÉS: Az üzemmód használatához tartsa lenyomva a BOOST gombot.

MAX: 20/40 perc*

Intenzív tisztítás és megszilárdult por. Minden szőnyegtipushoz ideális.

HIGH: 40/50/90 perc*

Karbantartó tisztításához. Ideális mindenféle kemény padlóhoz.

ECO: 1 óra 10/1 óra 30/2 óra 40 perc*

Enyhén szennyezett padlóhoz és kényes felületekhez: polcok, keretek, függönyök stb.

SZÜNET:

Ideiglenes leállítás használat közben.

A LED-ek jelzik a teljesítménymódokat. BOOST üzemmódban mindhárom zöld fény egyszerre villog.

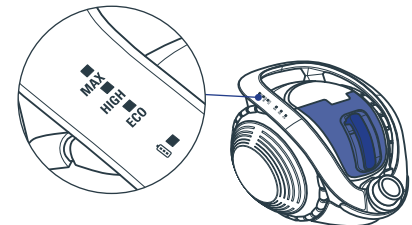

*Modelltől függően.

SZÍVÓFEJ

A két helyzetű szívófejhez pedálkapcsoló tartozik, amely lehetővé teszi a szőnyegnek vagy a kemény padlónak megfelelő helyzet kiválasztását.

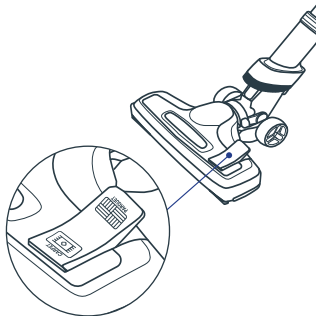

PARKETTA

Kemény padlónak megfelelő helyzet, kompatibilis a faparkettákkal, csempékkel, linóleummal stb.



SZŐNYEG

Szőnyeg pozíció, tökéletes bármilyen szőnyeg alapos porszívózásához.

TÁVIRÁNYÍTÓ

A készüléket a fogantyúba épített távirányító vezérli. CR2032 típusú, kerek elemmel működik.

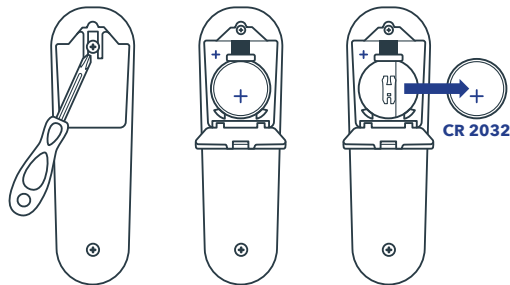

Javasoljuk, hogy 18 havonta cserélje ki az elemet.

Ha elveszne vagy megsérülne a távirányító, a BÉ gomb hosszú megnyomásával továbbra is bekapcsolhatja a készüléket.

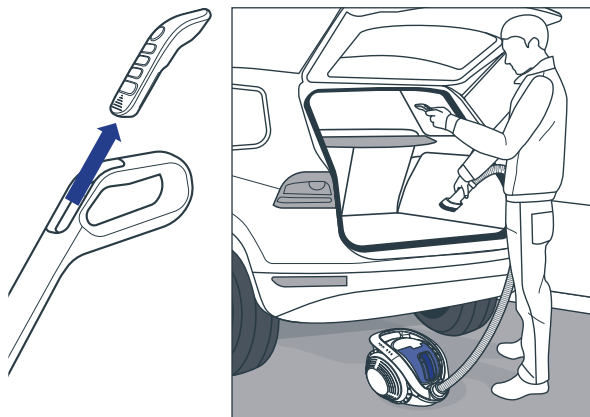

A távirányító levehető, így az összes tisztítás elvégezhető csak a rugalmas csővel is (ideális például autók tisztításához).

Hogyan használhatom a távirányítót?



AKKUMLÁTOR ÉS TÖLTÉS



AZ AKKUMULÁTOR TELJES TÖLTÉSE 4 ÓRÁT VESZ IGÉNYBE.

A készülék töltéséhez két lehetőség közül választhat:

1. OPCÍÓ

Csatlakoztassa a töltőt közvetlenül a porszívóhoz: először dugja be először a csatlakozót, majd csatlakoztassa a hálózathoz.

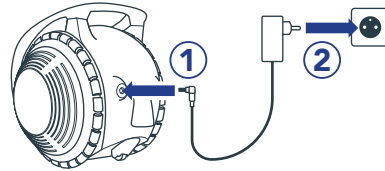

2. OPCÍÓ

Csatlakoztassa a töltőt az akkumulátorhoz. Ehhez vegye ki az akkumulátort a készülékből, dugja be a csatlakozót, majd csatlakoztassa a töltőt.

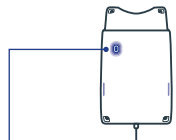
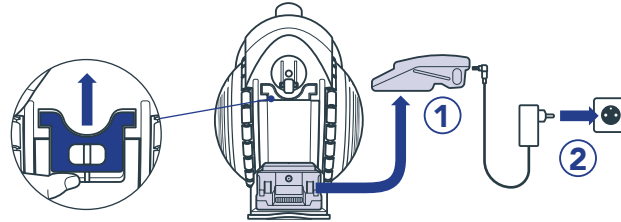

Kék fény világít: az akkumulátor töltődik.

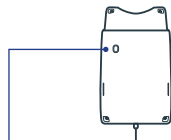

Kék fény nem világít: az akkumulátor fel van töltve.

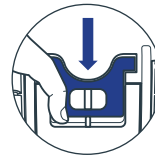
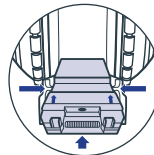

Olvassa be, hogy többet tudjon meg az akkumulátorról és annak töltéséről.



AZ AKKUMULÁTOR TÖLTÖTTESÉGE

A készülék jelzi a töltöttségi szintet:

- Három világító kék LED: 100%-os töltöttség.
- Két világító kék LED: 60%-os töltöttség.
- Egy kék LED villog: a készüléket fel kell tölteni.

Ha az akkumulátor teljesen lemerült, egy kék LED néhányszor felvillog.

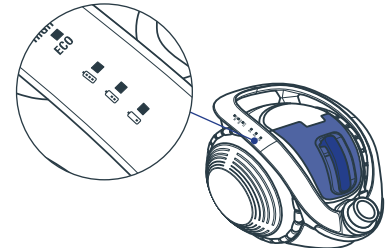

FLEX FUNKCIÓ

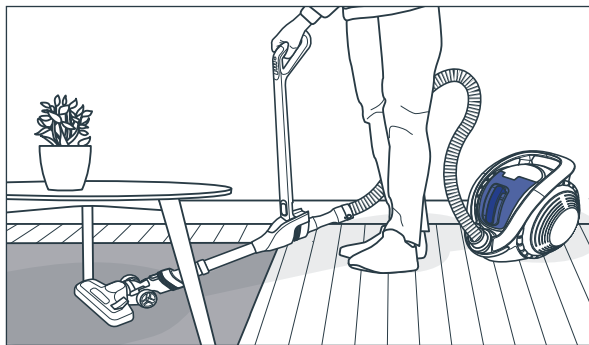

A készülék a Flex technológiával van felszerelve. Segítségével könnyedén elérheti a legtávolabbi területeket is az alacsony magasságú bútorok alatt. Aktiválásához csúsztassa felfelé a Flex gombot.

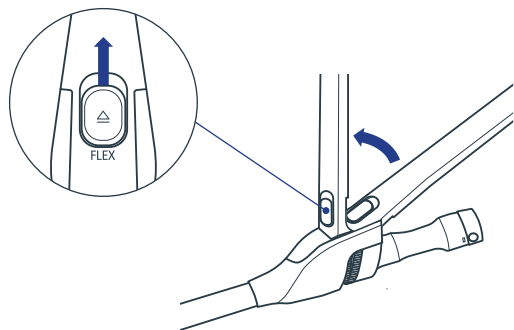

TARTOZÉKOK

A készülék két beépített Easy Dusting portörllő kefét tartalmaz. A legtöbb felület porszívózásához használhatja őket.

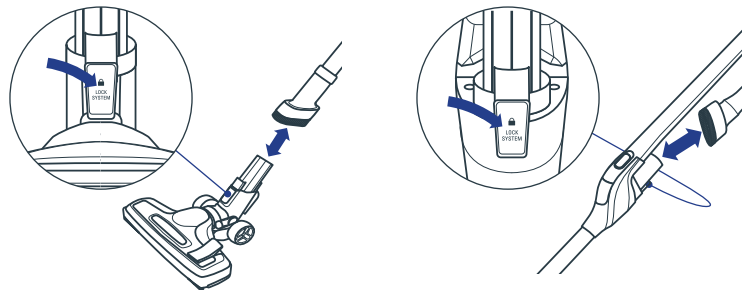

A speciális területek tisztításához használjon további tartozékokat: helyezze be őket az egyik csőbe amilyen mélyen csak lehet.

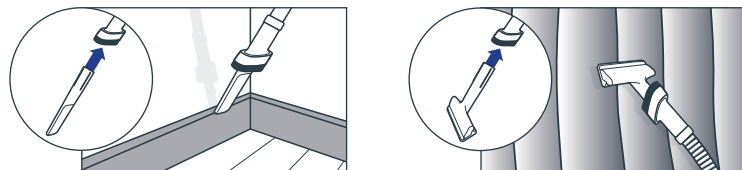

A rástisztító szívófej a nehezen elérhető helyek porszívózásához való.

A kanapékefe segítségével olyan textíliákat porszívózzon, mint a kanapé, a függönyök vagy a matrac.

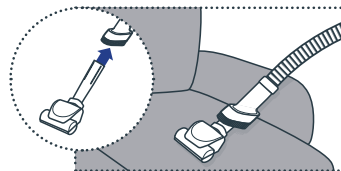

Használja a **mini turbó kefét a MAX vagy BOOST üzemmódban, hogy mélyre hatóan kiporszívózza a kanapét, a matracot vagy az autós szőnyegetek.

X-Ô

KAR- BAN- TARTÁS

Olvassa be a telefonja kamerájával vagy QR-kódolvasójával, hogy a lehető legtöbbet hozhassa ki a karbantartási tanácsokkal a porszívó teljesítményéből.



A PORTARTÁLY KIÜRÍTÉSE

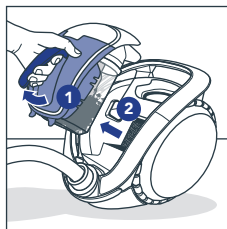
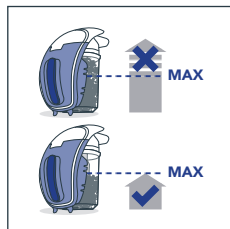

A CIKLONSZŰRŐ KARBANTARTÁSA

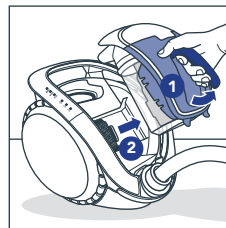
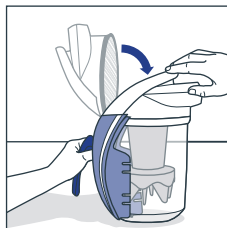
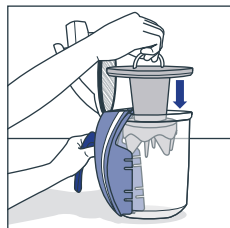
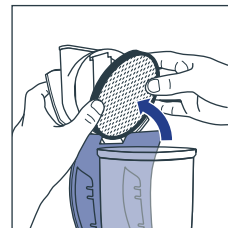
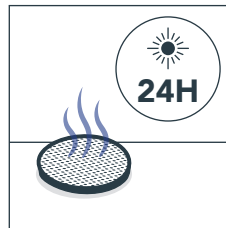
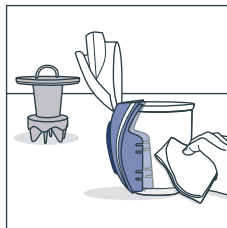
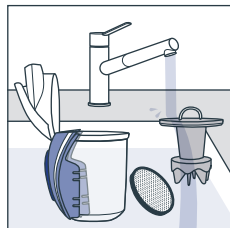

A portartály minden kiürítése után mossa le vízzel a ciklonszűrőt. Cserélje évente. Ha újat szeretne vásárolni, keresse a Rowenta ZR007700 hivatkozást.

A MOTORSZŰRŐ KARBANTARTÁSA

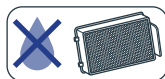

HAVONTA
EGYSZER

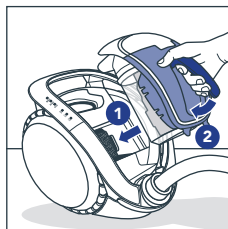
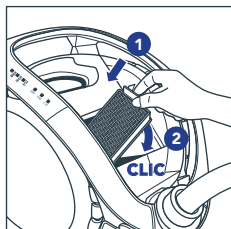
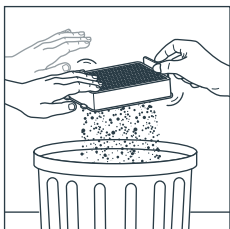
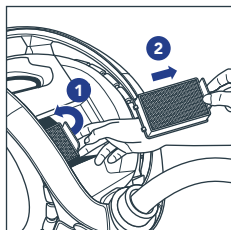
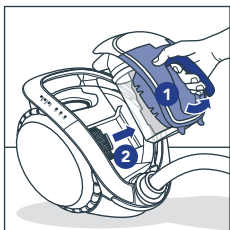

ÉVENTE
EGYSZER

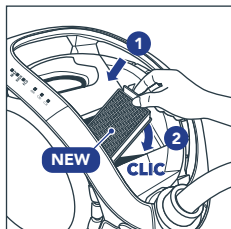
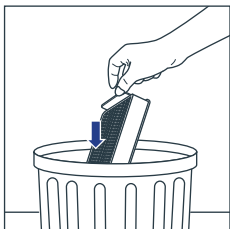

Évente cserélje ki a motorszűrőt.

Ha újat szeretne vásárolni, keresse a Rowenta ZR007700 hivatkozást.

A MINI TURBÓ KEFE TISZTÍTÁSA

Tisztítás előtt mindig vegye le a mini turbó kefe tartozékot (egyes típusoknál elérhető).

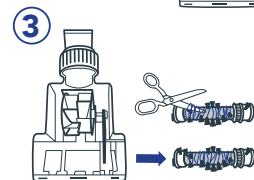
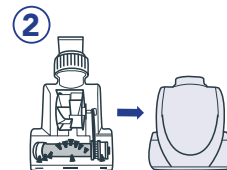

TÁROLÁS

1. OPCÍÓ

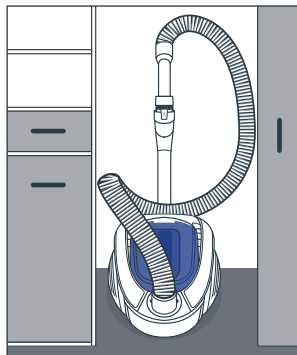
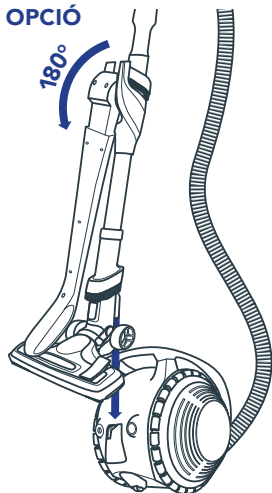

2. OPCÍÓ

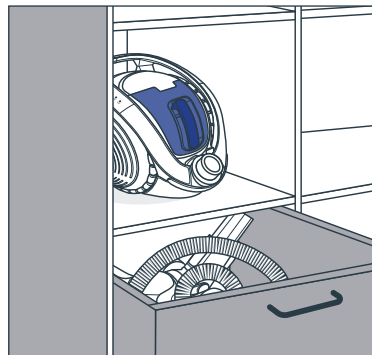
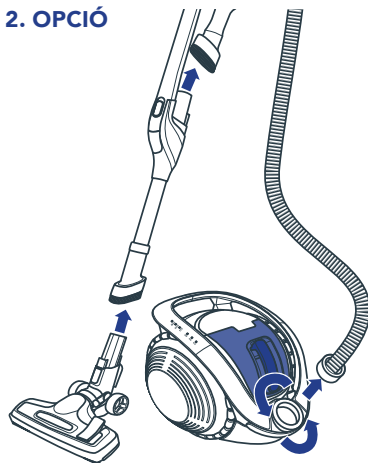

VIGYÁZAT

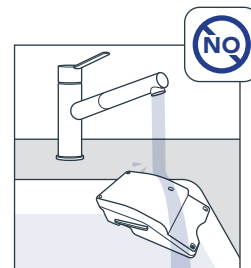

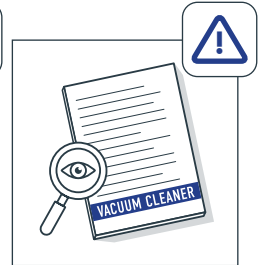
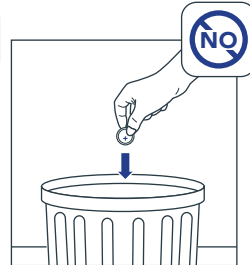
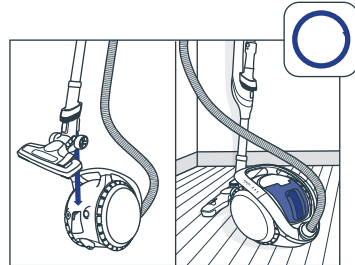
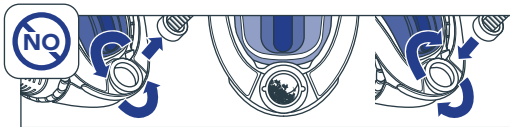
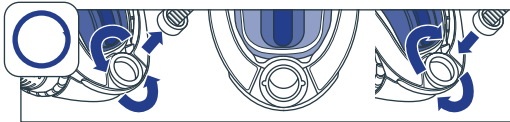
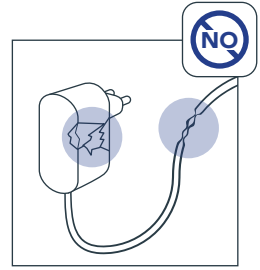
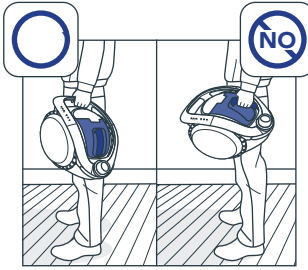
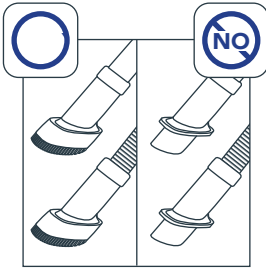
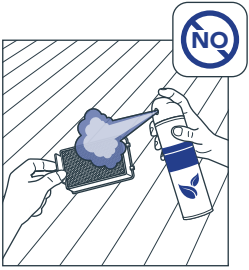
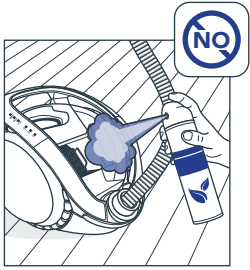
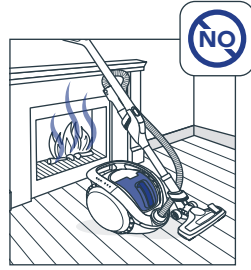
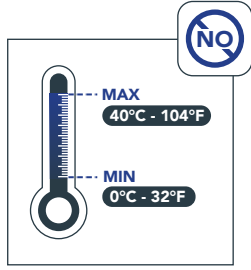



Vă mulțumim că ați ales să cumpărați un aspirator Rowenta X-Ö.

Aparatul dumneavoastră este echipat cu cele mai noi tehnologii Rowenta.

Citiți acest manual cu atenție pentru a profita la maximum de capacitățile aparatului dumneavoastră.

Scanați cu camera telefonului sau cu cititorul de coduri QR pentru a viziona un clip video util despre cum să vă asamblați aparatul.



ASAMBLARE



Avertisment! Pentru a afla ce trebuie făcut înainte de prima utilizare, consultați pagina 116.

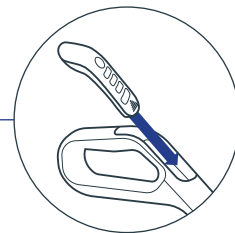
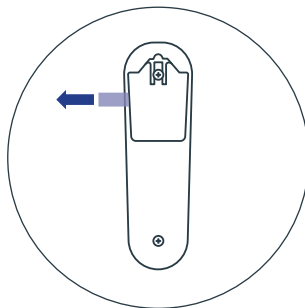

APARATUL DVS. VA TREBUI ÎNCĂRCAT COMPLET ÎNAINTE DE PRIMA UTILIZARE

Conectați mai întâi mufa jack, apoi introduceți în priză.

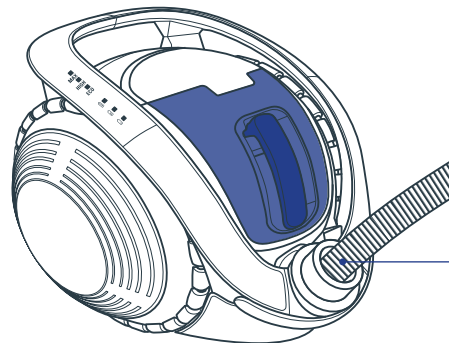
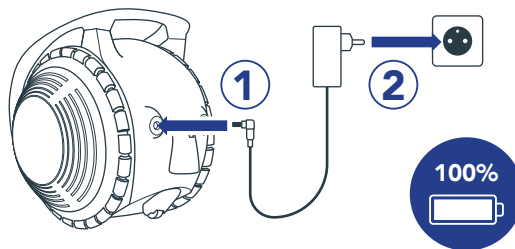

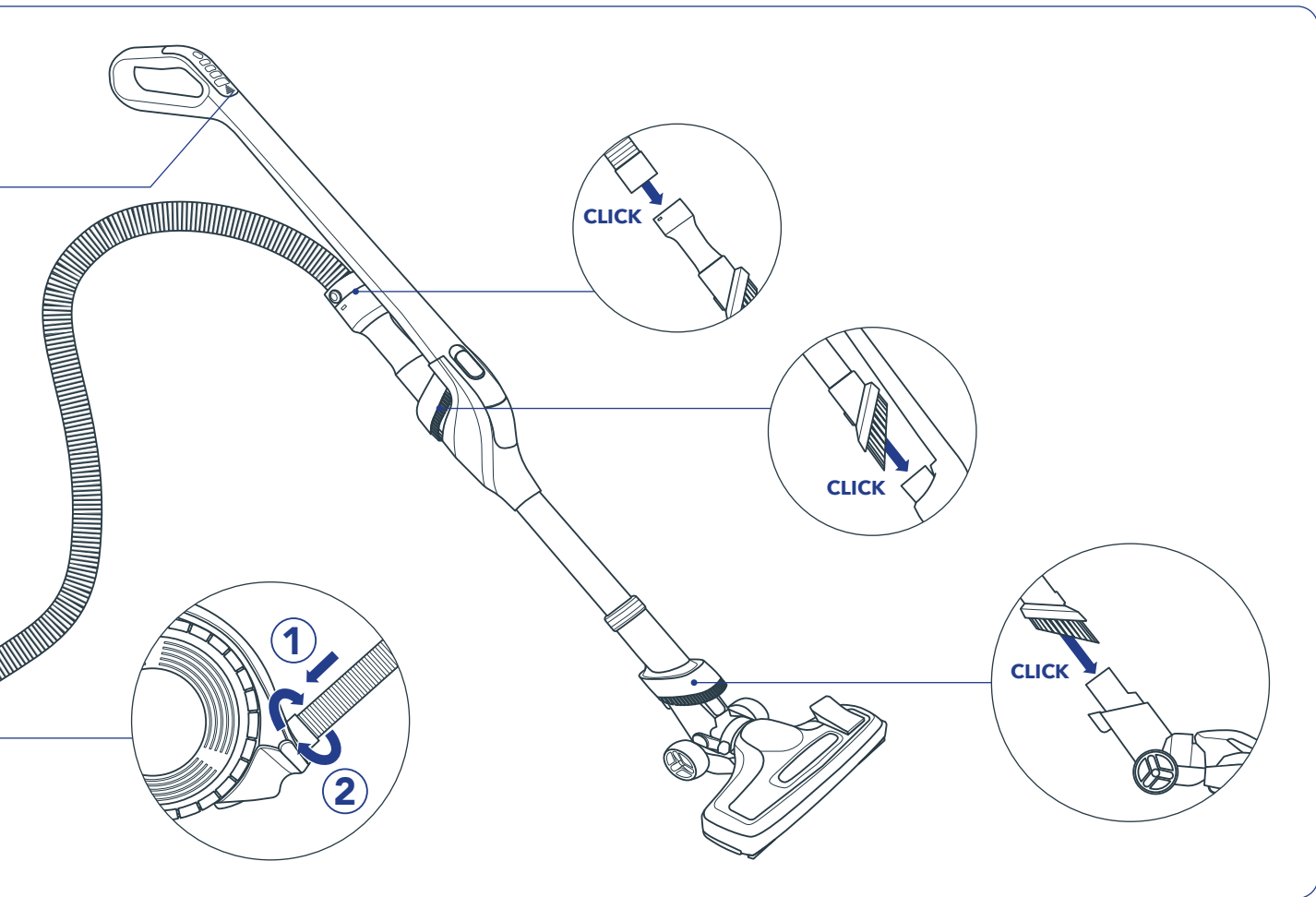

ÎNAINTE DE PRIMA UTILIZARE



Cum să asociez telecomanda?



Asociați telecomanda înainte de prima utilizare.

Acest pas se efectuează o singură dată.

	Ce trebuie să faceți:	Ce vedeți pe aparat:
1	Scoateți folia din plastic înainte de prima utilizare.	
2	<u>Porniți aparatul:</u> Apăsați butonul de pornire/oprire.	LED-urile albastre pentru baterie se aprind.
3.1	<u>Inițiere asociere:</u> Apăsați simultan butoanele MAX și II .	- Veți auzi un bip de confirmare - LED-urile albastre pentru baterie și LED-urile verzi pentru viteză clipesc alternativ
3.2	<u>Confirmare asociere:</u> Apăsați imediat după pasul 3.1 pe butonul II . (în timp ce LED-urile clipesc alternativ)	- LED-urile albastre continuă să se aprindă - Veți auzi un bip dublu Dacă nu auziți un bip dublu după 10 secunde: asocierea a eșuat. Opriți aparatul și începeți din nou de la pasul 2.

> Felicitări! V-ați asociat cu succes telecomanda.

BUTON DE PORNIRE/OPRIRE

Pentru a porni și opri aparatul, apăsați scurt pe butonul de alimentare.

Pentru a începe aspirarea, apăsați pe viteza ECO, HIGH (înaltă) sau MAX (maximă) de pe telecomandă.

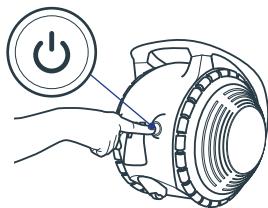

MOD PUTERE

Aparatul are 4 moduri de putere. Schimbați modurile de curățare folosind butoanele telecomenzii și ajustați puterea:

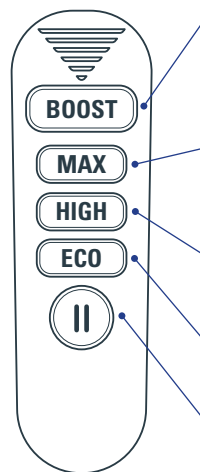

BOOST: 5/10 min*

Curățare profundă pentru murdărie dificilă.
N.B.: Mențineți apăsat butonul BOOST pentru a utiliza acest mod.

MAX: 20/40 min*

Curățare profundă și strat gros de praf. Ideal pentru toate tipurile de covoare.

HIGH: 40/50/90 MIN*

Pentru curățenie de întreținere. Ideal pentru toate tipurile de pardoseli dure.

ECO: 1 h 10/1 h 30/2 h 40 min*

Pentru pardoseli ușor murdare și suprafețe delicate: rafturi, rame, draperii etc.

PAUZĂ:

Oprire temporară în timpul utilizării.

LED-urile indică modurile de putere. În modul BOOST, toate cele trei lumini verzi vor clipi simultan.

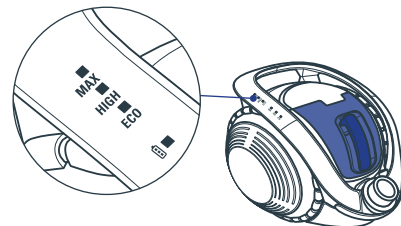

*în funcție de model.

DUZĂ DE ASPIRARE

Duza cu 2 poziții este echipată cu un buton de comutare care vă permite să schimbați între poziția pentru covor și cea pentru pardoseli dure.

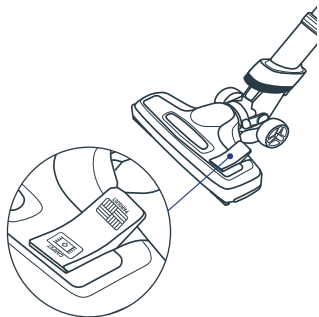

PARCHET

Poziția pentru pardoseli dure este potrivită pentru parchet din lemn, gresie, linoleum etc.



COVER

Poziția pentru covor este perfectă pentru aspirarea în profunzime a oricărui tip de covor sau mochetă.

TELECOMANDĂ

Aparatul este controlat cu ajutorul unei telecomenzi, care este integrată în mâner. Este alimentată de o baterie rotundă de tip CR2032.

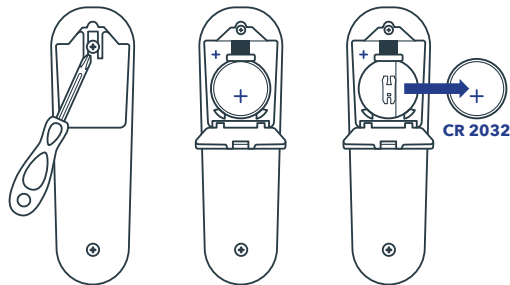

Recomandăm schimbarea bateriei o dată la 18 luni.

În caz de pierdere sau deteriorare a telecomenzii, puteți încă porni aparatul, apăsând lung pe butonul PORNIRE

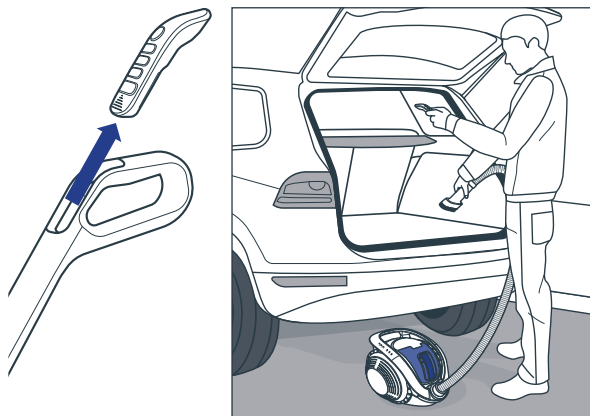

Puteți detașa telecomanda pentru a efectua sesiunile de curățare numai cu furtunul flexibil (ideal pentru curățarea mașinii, de exemplu).

Cum să folosesc telecomanda?



BATERIE ȘI RECICLARE



ÎNCĂRCAREA COMPLETĂ A BATERIEI DUREAZĂ 4 ORE.

Pentru a încărca aparatul, puteți alege între două opțiuni:

OPȚIUNEA 1

Conectați încărcătorul direct la aspirator: mai întâi mufa jack, apoi ștecărul la priză.

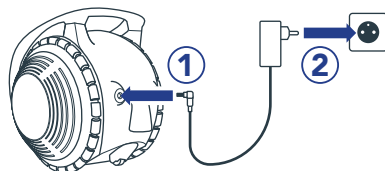

OPȚIUNEA 2

Conectați încărcătorul la baterie.

Pentru a face acest lucru, scoateți bateria din aparat, introduceți mufa jack și apoi conectați încărcătorul.

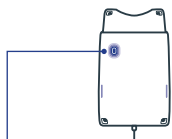
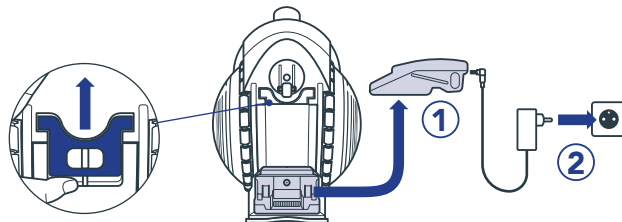

Lumina albastră aprinsă: bateria se încarcă.

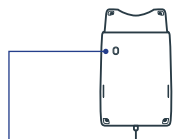

Lumina albastră stinsă: bateria este încărcată.

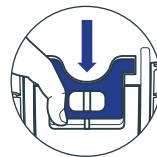
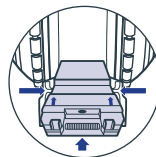

Scanați pentru a afla mai multe despre baterie și încărcarea sa.



STARE BATERIE

Aparatul indică nivelul de încărcare:

- 3 LED-uri albastre luminând: 100% încărcat.
- 2 LED-uri albastre luminând: 60% încărcat.
- 1 LED albastru clipind: aparatul trebuie încărcat.

Dacă bateria este complet descărcată, 1 LED albastru va clipi de câteva ori.

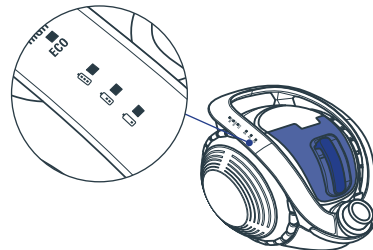

FUNCȚIA FLEX

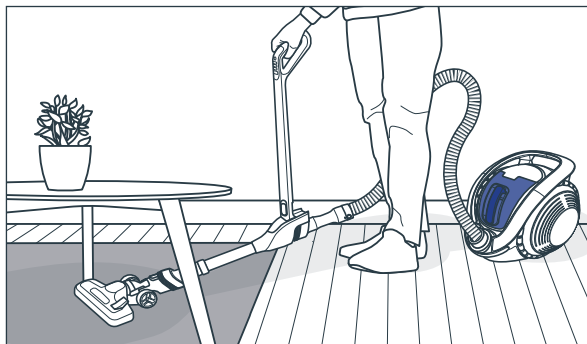

Aparatul dumneavoastră este echipat cu tehnologia Flex. Aceasta vă permite să ajungeți fără efort în zonele greu accesibile de sub mobilierul de înălțime mică. Pentru a o activa, glisați butonul Flex în sus.

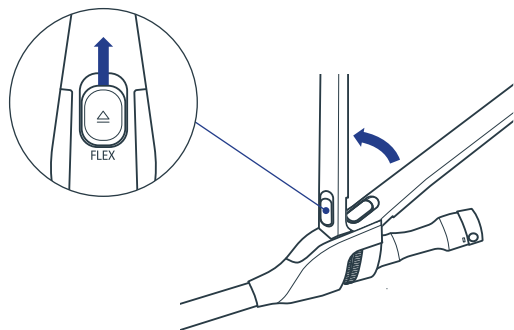

ACCESORII

Aparatul dvs. are 2 perii Easy Dusting integrate. Pot fi utilizate pentru a aspira majoritatea suprafețelor.

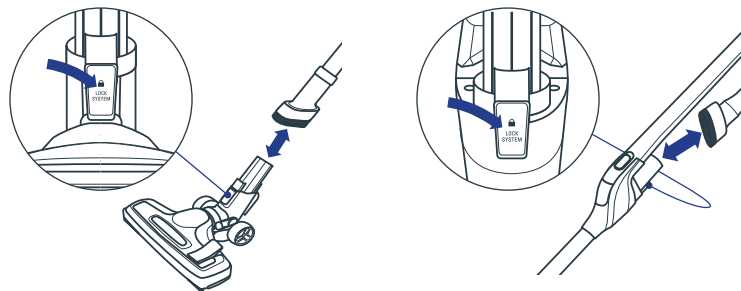

Pentru curățarea zonelor specifice, utilizați accesoriile suplimentare: introduceți-le în unul dintre tuburi la adâncime maximă.

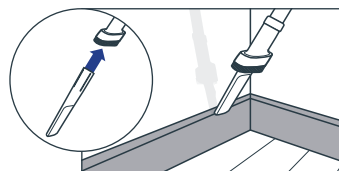

Utilizați accesoriul pentru spații înguste pentru a aspira zonele greu accesibile.

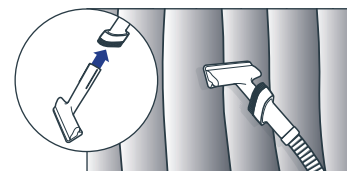

Utilizați peria pentru tapiserie pentru a aspira textile, precum canapele, draperii sau saltele.

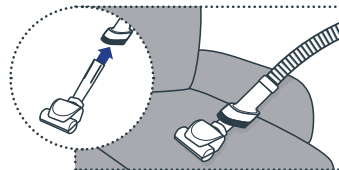

Utilizați **peria mini turbo în modul MAX sau BOOST pentru a aspira eficient canapelele, saltelele sau covorașele pentru mașină.

X-Ô

ÎNTREȚINERE

Scanați cu telefonul sau cu cititorul de coduri QR pentru a obține cele mai bune sfaturi de întreținere a aparatului.



GOLIREA RECIPIENTULUI DE PRAF

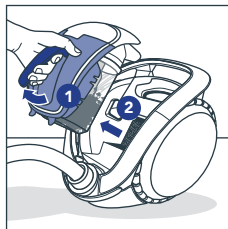
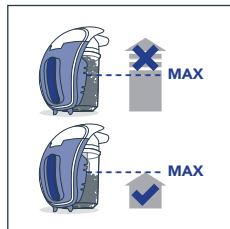

ÎNTREȚINEREA FILTRULUI CICLONULUI

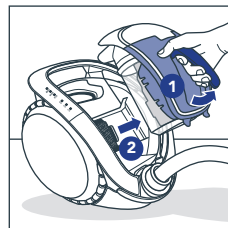
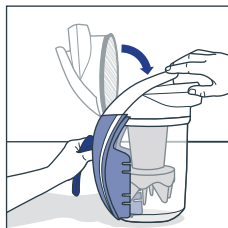
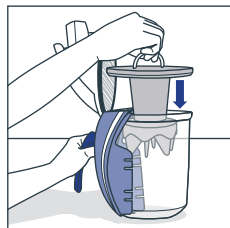
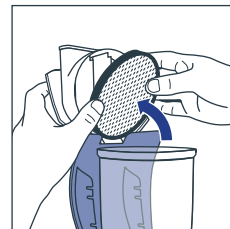
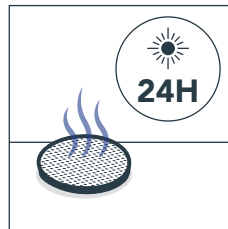
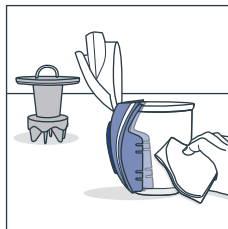
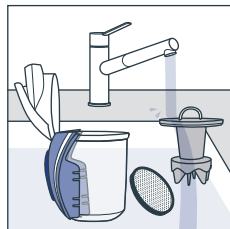

Spălați filtrul ciclone-lui cu apă după fiecare golire a recipientului de praf. Înlocuiți-l o dată pe an. Pentru a cumpăra unul nou, căutați numărul de referință Rowenta ZR007700.

ÎNȚEȚINEREA FILTRULUI PENTRU MOTOR



1X
LUNĂ

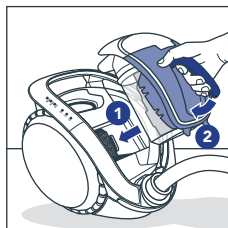
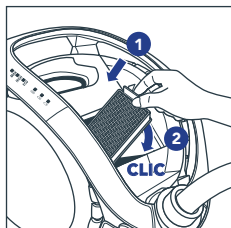
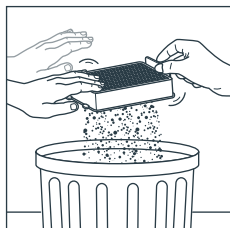
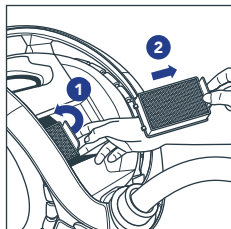
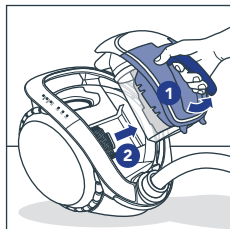

1X
AN

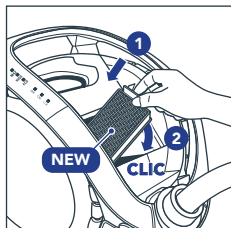
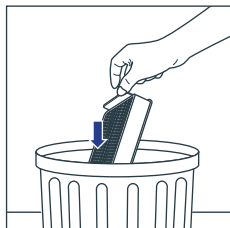

Înlocuiți filtrul moto-
rului o dată pe an.

Pentru a cumpăra
unul nou, căutați nu-
mărul de referință
Rowenta ZR007700.

CURĂȚAREA PERIEI MINI TURBO

Scoateți întotdeauna peria
mini turbo înainte de curățare
(disponibilă cu anumite modele).

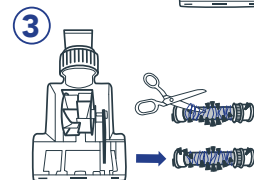
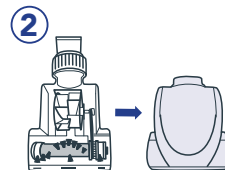

DEPOZITARE

OPȚIUNEA 1

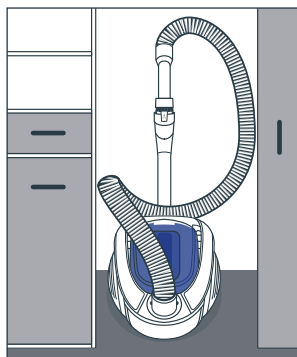
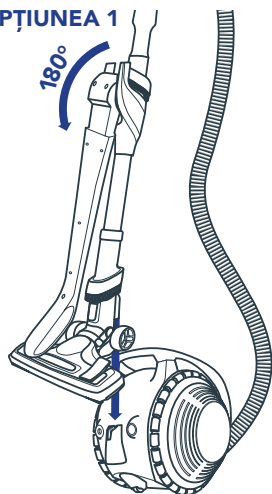

OPȚIUNEA 2

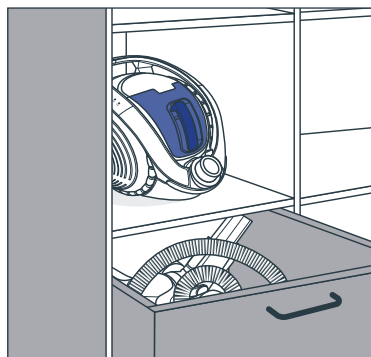
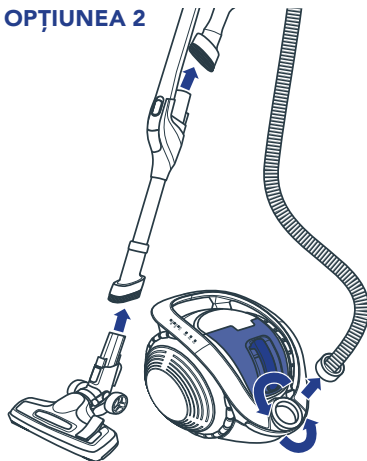

ATENȚIE

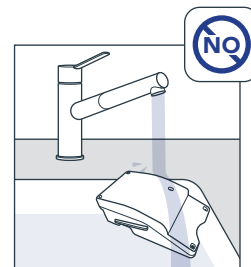

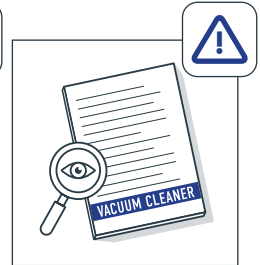
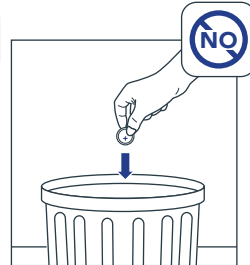
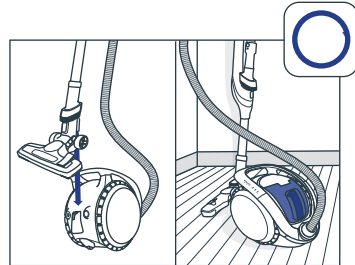
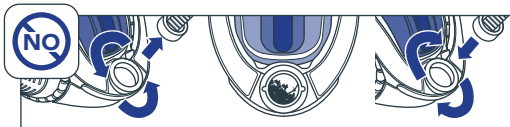
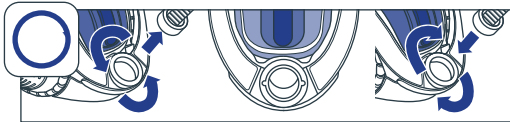
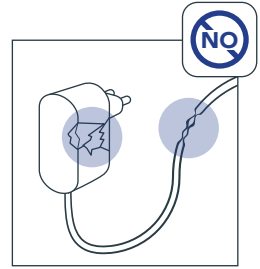
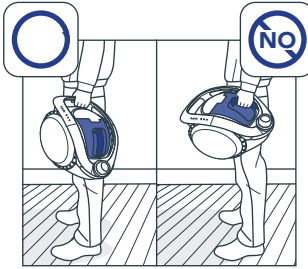
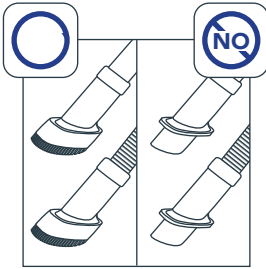
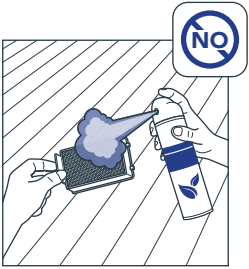
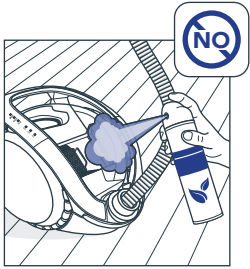
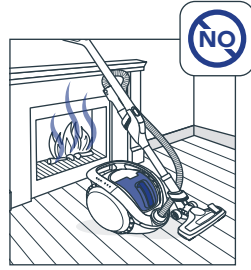
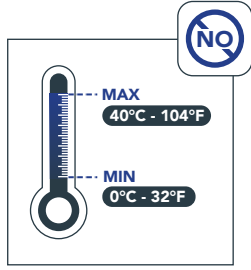



Благодарим Ви, че избрахте да закупите Rowenta X-Ö.

Вашият уред е оборудван с най-новите технологии на Rowenta.

Прочетете внимателно това ръководство, за да извлечете максимума от капацитета на Вашия уред.

Сканирайте с камерата на телефона си или QR четеца, за да гледате полезно видео ръководство за това как да сглобите Вашия уред.



МОНТАЖ



Предупреждение! За действие, което трябва да се предприеме преди първата употреба, вижте страница 126.

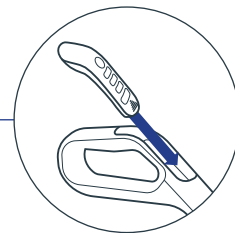
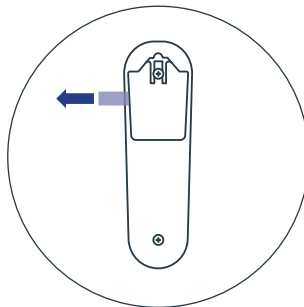

ВАШИЯТ УРЕД ТРЯБВА ДА БЪДЕ ЗАРЕДЕН НАПЪЛНО ПРЕДИ ПЪРВА УПОТРЕБА

Първо свържете жака, преди да включите в мрежата.

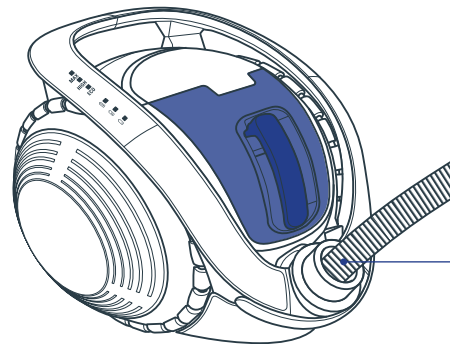
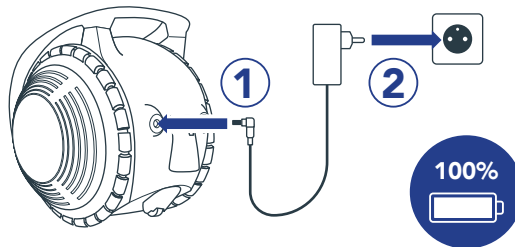

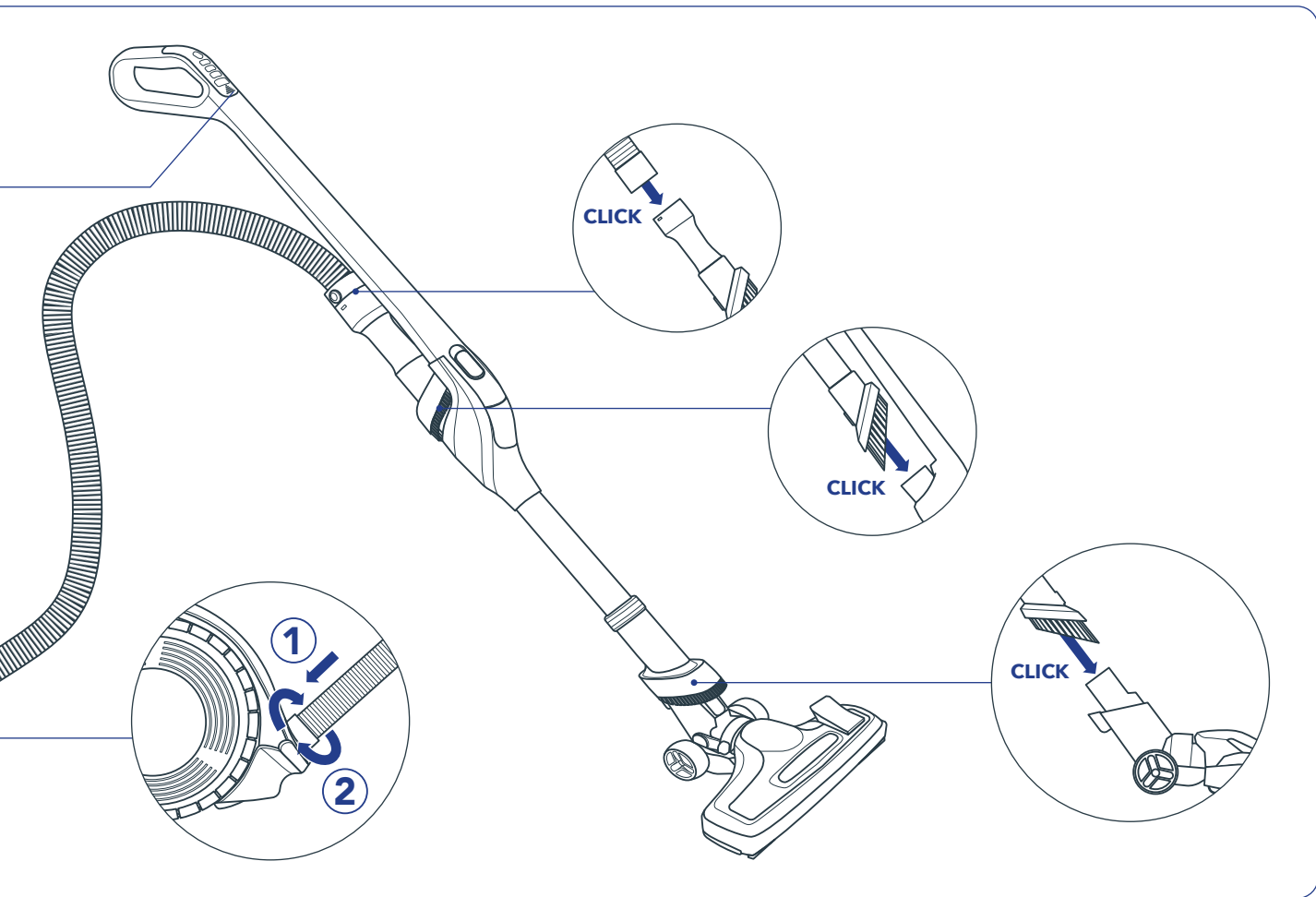

ПРЕДИ ПЪРВАТА УПОТРЕБА



Как да сдвоя дистанционното си управление?



Сдвоете дистанционното си управление преди първата употреба.

Извършва се само веднъж.

	Какво трябва да направите:	Какво можете да видите на Вашия уред:
1	Свалете пластмасовия капак преди първата употреба.	
2	Включване на уреда: Натиснете бутона за вкл./изкл.	Сините светодиоди на батерията светят.
3.1	Стартиране на сдвояване: Натиснете едновременно бутоните MAX (МАКС.) и II .	- Чува се звук сигнал за потвърждение - Сините светодиоди на батерията и светодиодите на зелените индикатори за скорост мигат последователно
3.2	Потвърждение на сдвояването: Натиснете веднага след стъпка 3.1 бутон II . (докато светодиодите мигат последователно)	- Сините светодиоди продължават да светят - Чувате звук сигнал два пъти Ако не чуете звук сигнал два пъти след 10 секунди: сдвояването е неуспешно. Изключете уреда и започнете отново от стъпка 2.

Честито! Успешно сдвоихте Вашето дистанционно управление.

ВКЛ./ИЗКЛ. НА БУТОНА ЗА ЗАХРАНВАНЕ

За да включите и изключите Вашия уред, натиснете без задържане бутона за захранване.

За да започнете да почиствате с прахосмукачката, натиснете скорост ECO (ЕКО), HIGH (ВИСОКА) или MAX (МАКС.) на Вашето дистанционно.

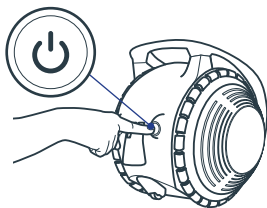

РЕЖИМ НА МОЩНОСТ

Вашият уред има 4 режима на мощност. Променете режимите на почистване с помощта на бутоните на дистанционното управление и регулирайте мощността:

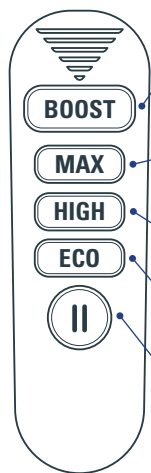

BOOST (ПОДСИЛВАНЕ): 5 минути/10 минути*

Интензивно почистване на упорити замърсявания.

ЗАБЕЛЕЖКА: Задръжте бутона BOOST (ПОДСИЛВАНЕ) натиснат, за да използвате този режим.

MAX (МАКС.): 20/40 минути*

Интензивно почистване и изсмукване на застоял прах. Идеален за всички видове килими.

HIGH (ВИСОКА): 40/50/90 МИНУТИ*

За поддържащо почистване. Идеален за всички видове твърда настилка.

ECO (ЕКО): 1 час и 10 минути/1 час и 30 минути/2 часа и 40 минути*

За леко замърсени подове и деликатни повърхности: рафтове, рамки, завеси и др.

PAUSE (ПАУЗА):

Временно изключване по време на употреба.

Светлодиодите обозначават режимите на мощност. В режим BOOST (ПОДСИЛВАНЕ) и трите зелени светлини ще светнат едновременно.

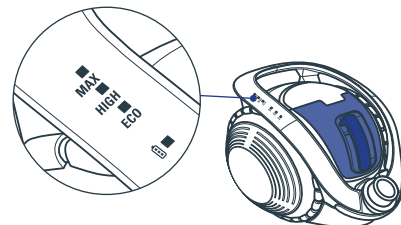

*В зависимост от модела.

ПОЧИСТВАЩА ЧЕТКА

Вашата четка с 2 позиции е оборудвана с педален превключвател, който Ви позволява да промените позицията за килим или за твърд под.

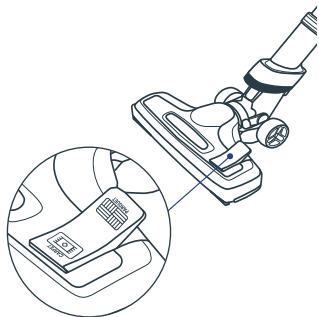

PARQUET (ПАРКЕТ)

Позиция за твърд под, съвместима с дървен паркет, плочки, линолеум и др.



CARPET (КИЛИМ)

Позиция за килим, идеална за дълбоко почистване с прахосмукачката на всеки килим или черга.

ДИСТАНЦИОННО УПРАВЛЕНИЕ

Вашият уред се управлява от дистанционно управление, вградено в дръжката. То се захранва от кръгла батерия, тип CR2032.

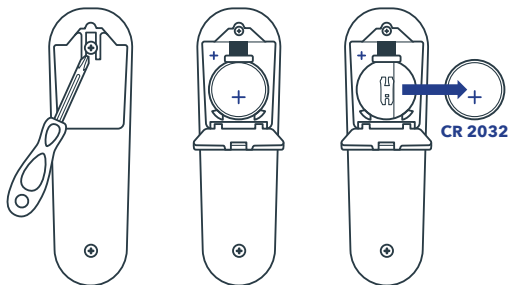

Препоръчваме Ви да сменяте батерията на всеки 18 месеца.

В случай на загуба или повреда на Вашето дистанционно управление все още можете да включите уреда, като натиснете продължително бутон ON (ВКЛ.)

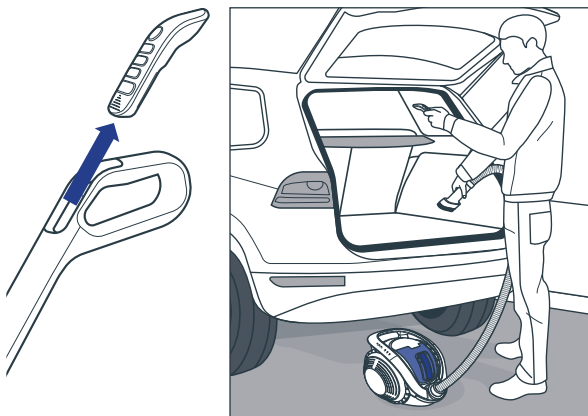

Можете да разкачите дистанционното управление, за да извършвате всичките почистващи сесии само с гъвкавия маркуч (идеален за почистване, например, на Вашия автомобил).

Как да използвам дистанционното управление?



БАТЕРИЯ И ЗАРЕЖДАНЕ



ПЪЛНОТО ЗАРЕЖДАНЕ НА БАТЕРИЯТА ПРОДЪЛЖАВА 4 ЧАСА.

При зареждане на Вашия уред може да избирате между две опции:

ОПЦИЯ 1

Свържете директно зарядното устройство към прахосмукачката: първо поставете жака, след което включете в мрежата.

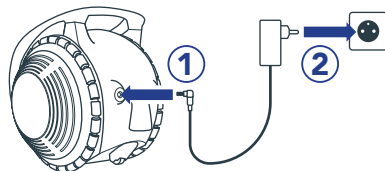

ОПЦИЯ 2

Свържете зарядното устройство към батерията. За целта свалете батерията от уреда, поставете жака и след това включете зарядното устройство в мрежата.

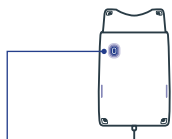
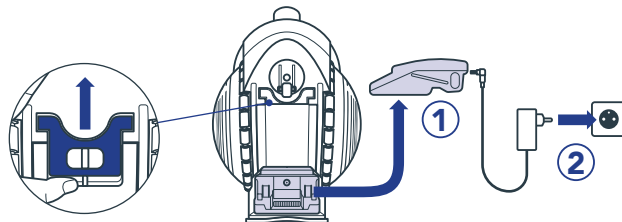

Синята светлина свети: батерията се зарежда.

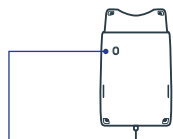

Синята светлина не свети: батерията е заредена.

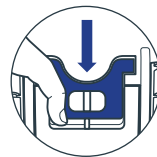
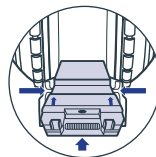

Сканирайте, за да научите повече за батерията и зареждането ѝ.



СЪСТОЯНИЕ НА БАТЕРИЯТА

Вашият уред показва нивото на зареждане:

- Светят 3 сини светодиода: 100% заредена.
- Светят 2 сини светодиода: 60% заредена.
- Примигва 1 син светодиод: уредът трябва да се презареди.

Ако батерията е напълно изтощена, 1 син светодиод примигва няколко пъти.

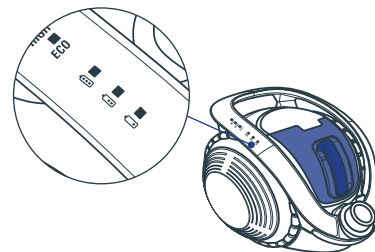

ФУНКЦИЯ FLEX

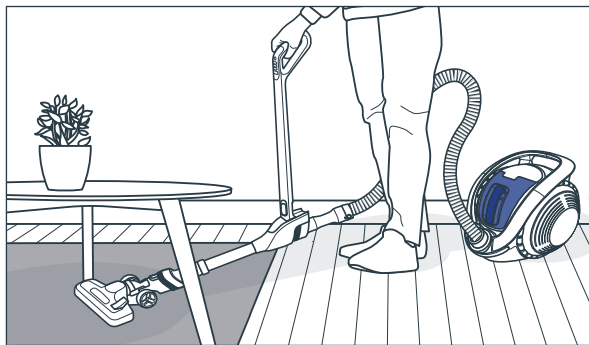

Вашият уред е оборудван с технология Flex. Това Ви позволява да достигнете без усилие до най-отдалечените места под ниски мебели.

За да я активирате, плъзнете нагоре бутона Flex.

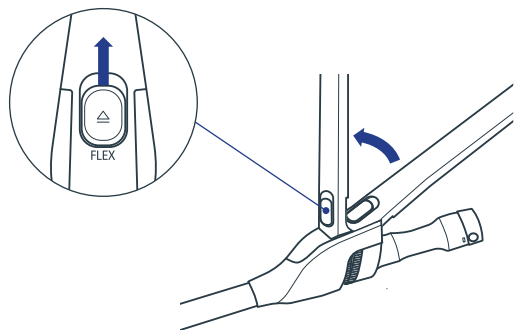

АКСЕСОАРИ

Вашият уред има 2 вградени четки за лесно почистване. Можете да ги използвате за почистване с прахосмукачката на повечето повърхности.

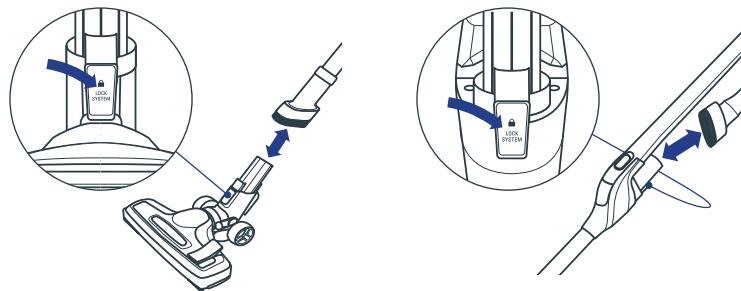

За почистване на специфични места използвайте допълнителни аксесоари: поставете ги в някоя от тръбите на максимална дълбочина.

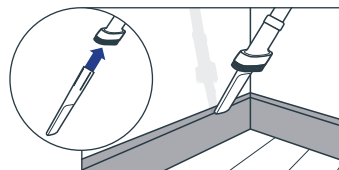

Използвайте накрайника за тесни пространства, за да почистите с прахосмукачката труднодостъпни места.

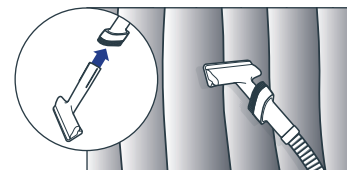

Използвайте четката за мека мебел, за да почистите с прахосмукачката текстилни изделия, като дивани, завеси или матраци.

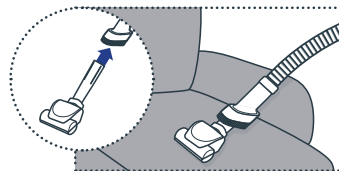

**Използвайте мини турбочетката в режим MAX (МАКС.) или BOOST (ПОДСИЛВАНЕ), за да почистите с прахосмукачката в дълбочина дивани, матраци или постелки за кола.

X-Ô

ПОДДРЪЖКА

Сканирайте с телефона си или QR четеца, за да извлечете максимума от съветите за поддръжка за най-добри резултати.



ИЗПРАЗВАНЕ НА КОНТЕЙНЕРА ЗА ПРАХ

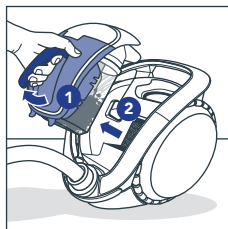
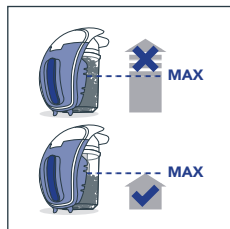

ПОДДРЪЖКА НА ЦИКЛОННИЯ ФИЛТЪР

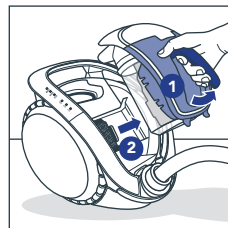
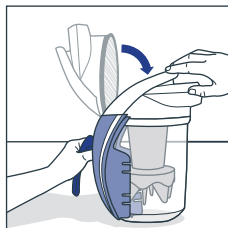
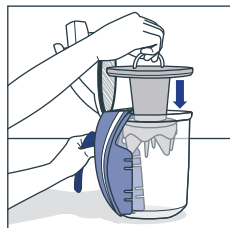
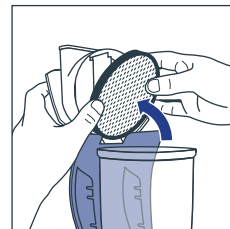
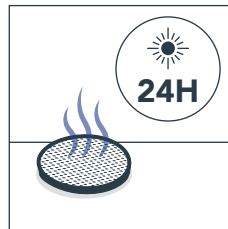
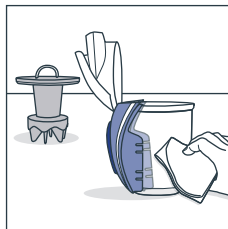
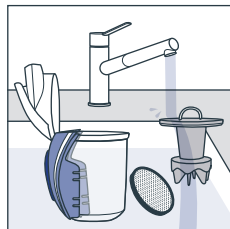

Измивайте с вода циклонния филтър след всяко изпразване на контейнера за прах. Сменяйте го веднъж годишно. За да купите нов, вижте за справка Rowenta ZR007700.

ПОДДРЪЖКА НА ФИЛТЪРА НА МОТОРА

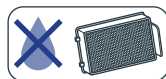

1X
МЕСЕЦ

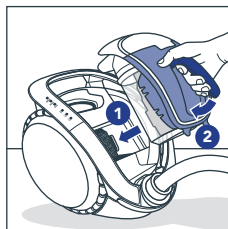
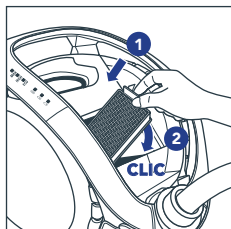
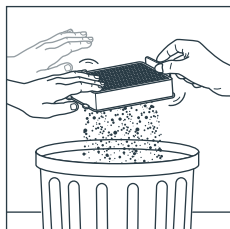
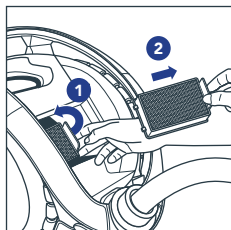
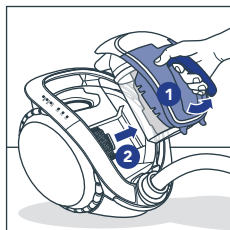

1X
ГОДИНА

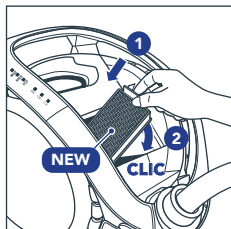
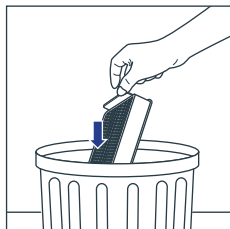

Сменяйте филтъра на мотора веднъж годишно. За да купите нов, вижте за справка Rowenta ZR007700.

ПОЧИСТВАНЕ НА МИНИ ТУРБОЧЕТКАТА

Задължително сваляйте мини турбочетката преди почистване (налична за някои модели).

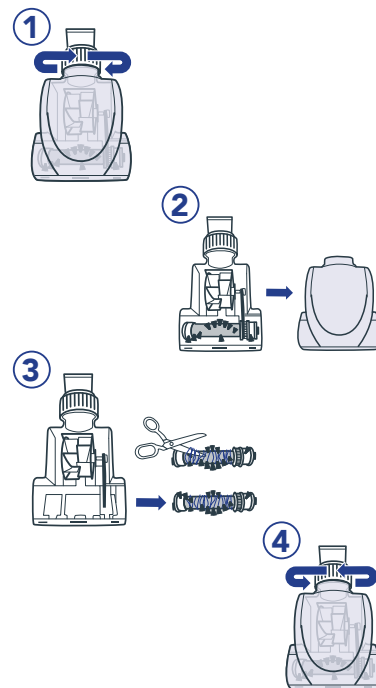

СЪХРАНЕНИЕ

ОПЦИЯ 1

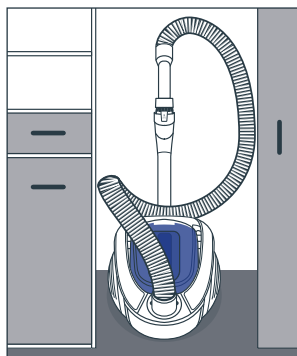
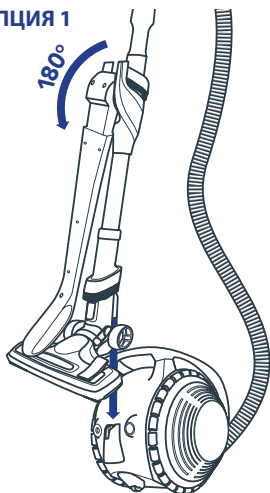

ОПЦИЯ 2

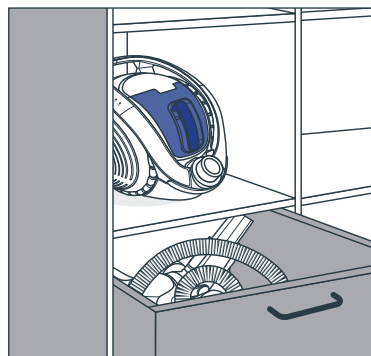
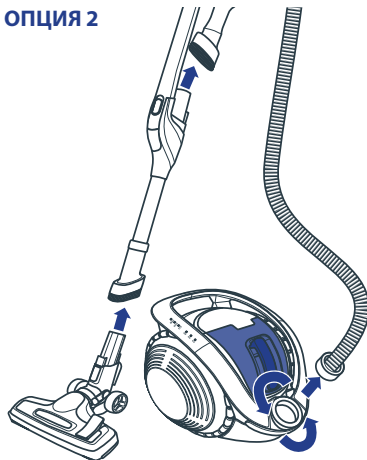

ВНИМАНИЕ

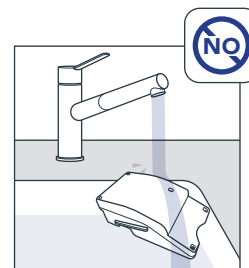

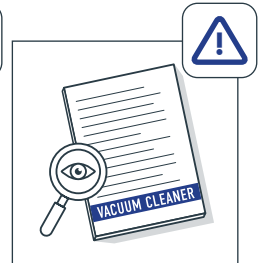
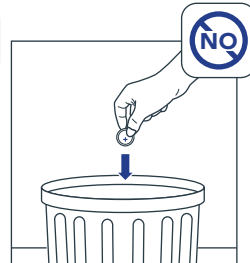
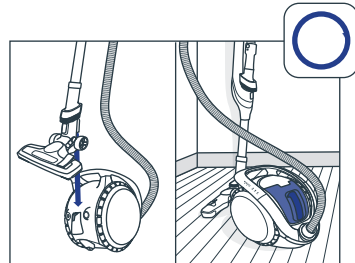
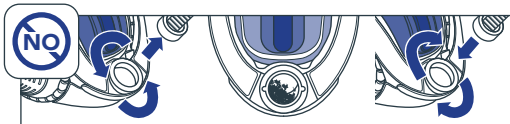
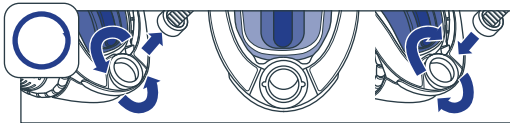
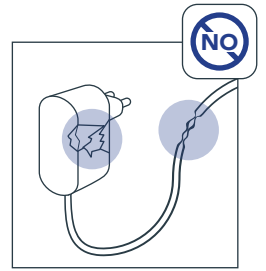
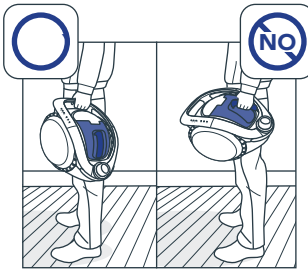
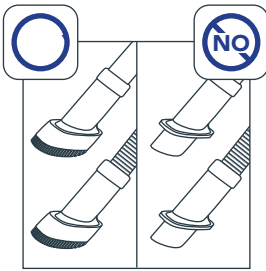
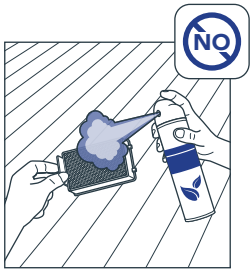
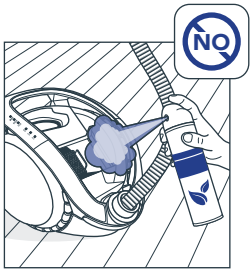
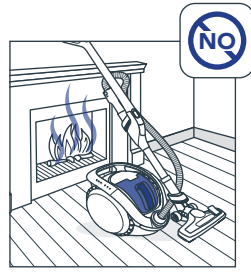
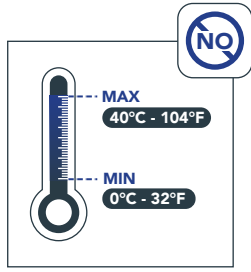



Hvala što ste se odlučili kupiti uređaj Rowenta X-Ö.

Vaš uređaj opremljen je najnovijim Rowenta tehnologijama.

Pažljivo pročitajte ovaj priručnik kako biste iskoristili maksimalne kapacitete vašeg uređaja.

Skenirajte kamerom pametnog telefona ili čitačem QR koda kako biste pogledali koristan videozapis o tome kako sastaviti vaš uređaj.



SASTAVLJANJE



Upozorenje!
Radnju koju trebate poduzeti prije prve uporabe potražite na 136. stranici.

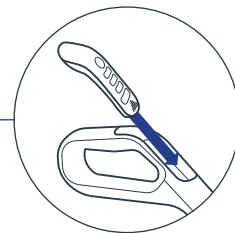
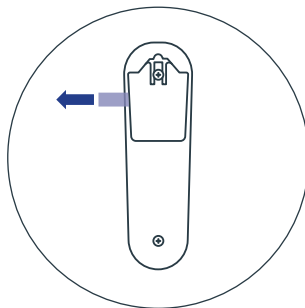

UREĐAJ JE POTREBNO U POTPUNOSTI NAPUNITI PRIJE PRVE UPORABE

Prije uključivanja spojite priključak.

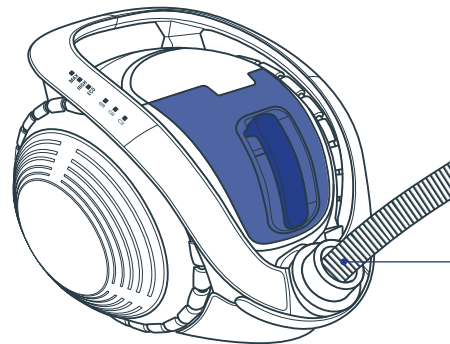
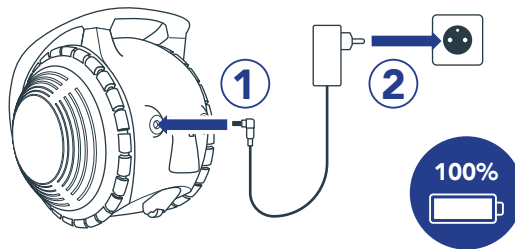

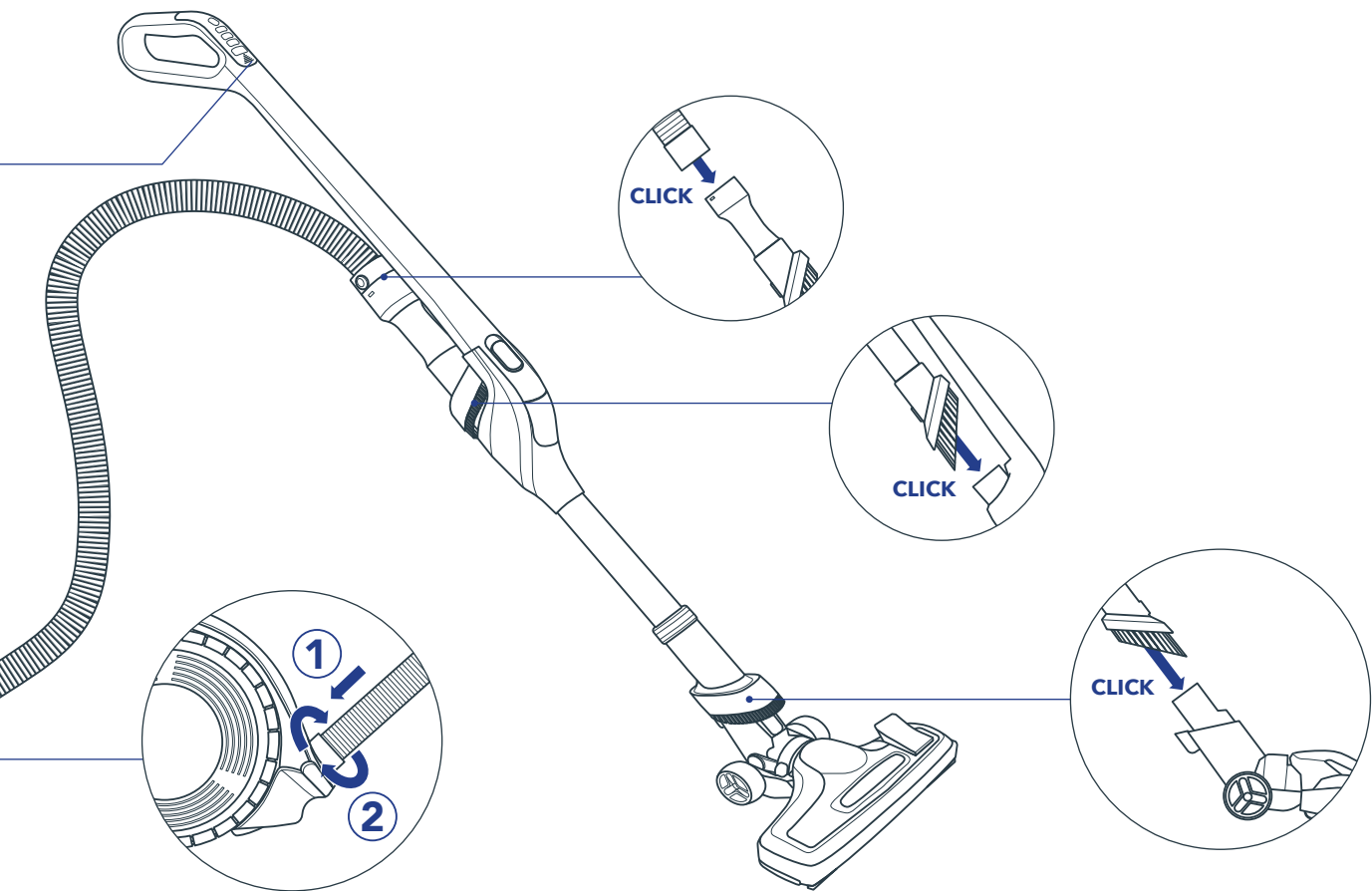

PRIJE PRVE UPORABE



Kako upariti moj daljinski upravljač?



Prije prve uporabe uparite daljinski upravljač.

To je potrebni učiniti samo jedanput.

	Što je potrebno učiniti:	Što možete vidjeti na vašem uređaju:
1	Prije prve uporabe skinite plastični jezičak.	
2	Uključivanje uređaja: Pritisnite tipku za uključivanje/isključivanje.	Plavi LED indikatori za bateriju svijetle.
3.1	Pokretanje uparivanja: Pritisnite, u isto vrijeme, tipke MAX i II .	- Čut ćete zvučni signal za potvrdu - Plavi LED indikatori za bateriju i zeleni LED indikatori brzine naizmjenično trepere
3.2	Potvrda uparivanja: Odmah nakon koraka 3.1. pritisnite tipku II . (dok LED indikatori naizmjenično trepere)	- Plavi LED indikatori i dalje svijetle - Čut ćete dvostruki zvučni signal Ako niste čuli dvostruki zvučni signal nakon 10 sekundi: uparivanje nije uspjelo. Isključite uređaj i ponovno započnite od 2. koraka.

➤ Čestitamo! Uspješno ste uparili daljinski upravljač.

TIPKA ZA UKLJUČIVANJE/ISKLJUČIVANJE

Za uključivanje i isključivanje uređaja kratko pritisnite tipku za uključivanje.

Za početak usisavanja pritisnite brzinu ECO, HIGH ili MAX na daljinskom upravljaču.

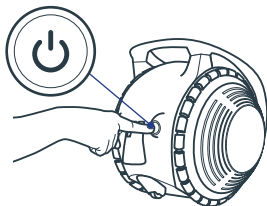

NAČIN RADA

Vaš uređaj ima četiri načina rada. Promijenite načine čišćenja s pomoću tipki na daljinskom upravljaču i namjestite snagu:

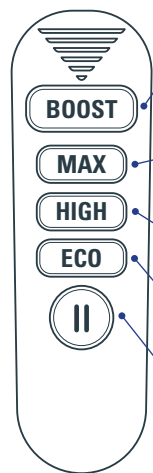

BOOST: 5 min / 10 min*

Intenzivno čišćenje za tvrdokornu prljavštinu.

NAPOMENA: Neprestano pritišćite tipku BOOST za uporabu ovog načina rada.

MAX: 20 / 40 min*

Intenzivno čišćenje i skorena prašina. Idealno za uporabu na svim vrstama tepiha.

HIGH: 40 / 50 / 90 min*

Za održavanje. Idealno za sve vrste parketa.

ECO: 1 sat 10 min / 1 sat 30 min / 2 sata 40 min*

Za blago zaprljane podove i osjetljive površine: police, okvire, zavjese itd.

ZAUSTAVLJANJE:

Privremeno isključivanje tijekom uporabe.

LED indikatori prikazuju načine rada. U načinu rada BOOST sva tri zelena indikatora treperit će istodobno.

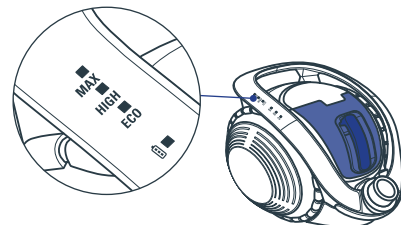

MAZNICA ZA USIS

Mlaznica koja ima dva položaja opremljena je papučicom koja vam omogućuje promjenu položaja za tepihe i položaja za parkete.

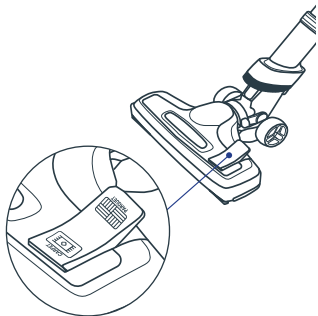

PARKET

Položaj za parket, kompatibilno s drvenim parketima, pločicama, linoleumom itd.



TEPIH

Položaj za tepih, savršeno za dubinsko usisavanje svih vrsta tepiha.

DALJINSKI UPRAVLJAČ

Uređajem upravljate s pomoću daljinskog upravljača koji je integriran u ručku. Napaja se baterijom vrste CR2032.

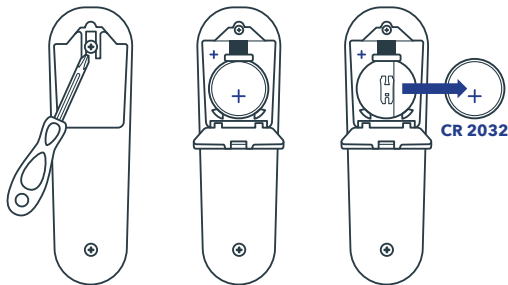

Savjetujemo vam da bateriju mijenjate svakih 18 mjeseci.

U slučaju gubitka ili oštećenja daljinskog upravljača i dalje možete uključiti uređaj dugim pritiskom tipke za uključivanje

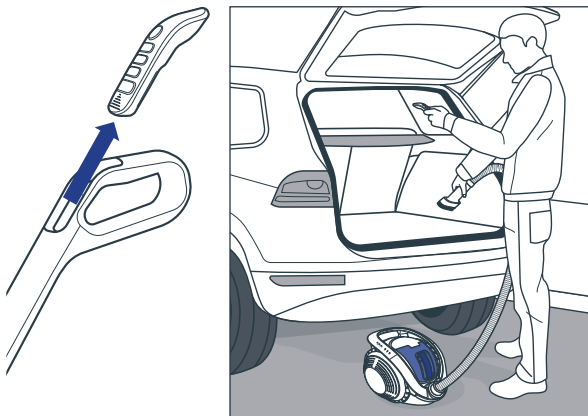

Daljinski upravljač možete odvojiti kako biste obavili sve postupke čišćenja samo s fleksibilnim crijevom (idealno za čišćenje automobila, na primjer).

Kako rabiti daljinski upravljač?



BATERIJA I PUNJENJE



TRAJANJE POTPUNOG PUNJENJA BATERIJE IZNOSI 4 SATA.

Za punjenje uređaja možete birati između dvije opcije:

OPCIJA 1

Spojite punjač izravno na usisivač: prvo umetnite priključak, a zatim ukopčajte.

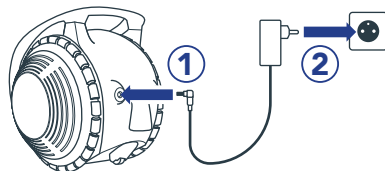

OPCIJA 2

Spojite punjač na bateriju. Da biste to učinili, izvadite bateriju iz uređaja, umetnite priključak i ukopčajte punjač.

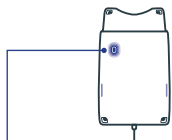
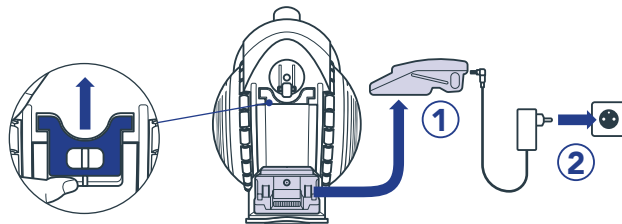

Plavo svjetlo svijetli:
baterija se puni.

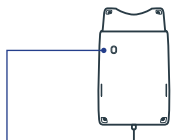

Plavo svjetlo ne svijetli:
baterija je napunjena.

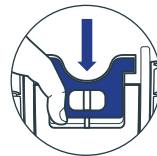
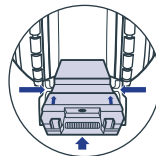

**Skenirajte kako biste saznali
više o bateriji i punjenju.**



STATUS BATERIJE

Vaš uređaj prikazuje razinu punjenja:

- tri plava LED indikatora svijetle: 100 % napunjeno.
- dva plava LED indikatora svijetle: 60 % napunjeno.
- jedan plavi LED indikator treperi: uređaj je potrebno napuniti.

Ako je baterija u potpunosti ispražnjena, jedan plavi LED indikator treperi nekoliko puta.

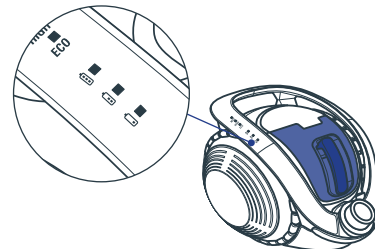

FUNKCIJA FLEX

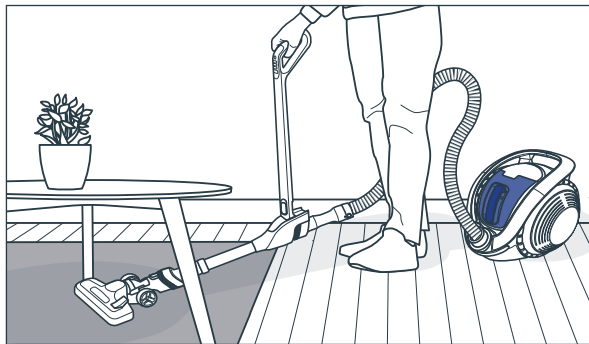

Vaš uređaj opremljen je Flex tehnologijom. Ona vam omogućuje da bez napora dosegnete najudaljenija područja ispod niskog namještaja. Kako biste je aktivirali, povucite tipku Flex prema gore.

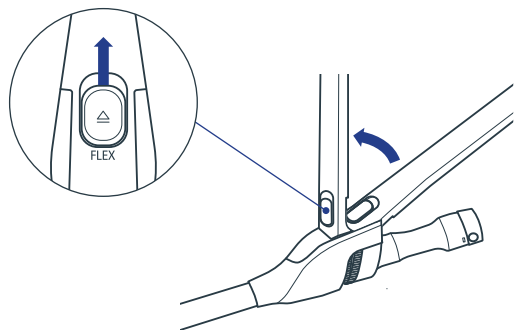

DODATNA OPREMA

Vaš uređaj ima dvije integrirane četke za lako uklanjanje prašine. Možete ih rabiti za usisavanje većine površina.

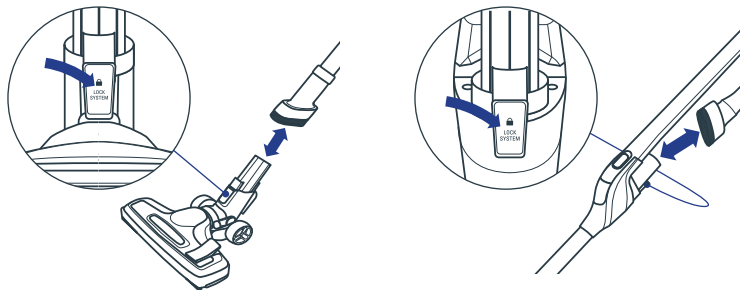

Za čišćenje određenih područja rabite dodatnu opremu: umetnite ih u jednu od cijevi do maksimalne dubine.

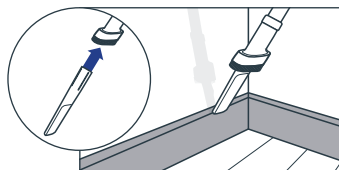

Rabite alat za utore za usisavanje teško dostupnih područja.

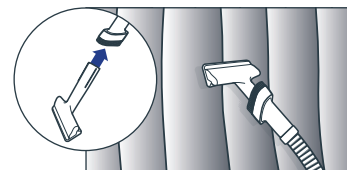

Rabite alat za sofe za usisavanje teksta poput sofa, zavjesa ili madraca.

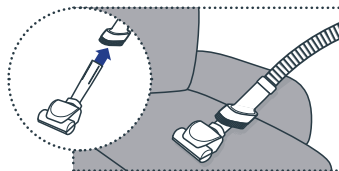

**Rabite mini turbo četkicu u načinu MAX ili BOOST za dubinsko usisavanje sofa, madraca ili otirača u automobilu.

X-Ö

ODRŽAVANJE

Skenujte pametnim telefonom ili čitačem QR koda kako biste izvukli najviše od savjeta za održavanje za najbolju izvedbu.



PRAŽNENJE SPREMNIKA ZA PRAŠINU

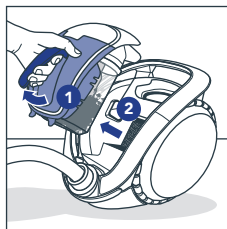
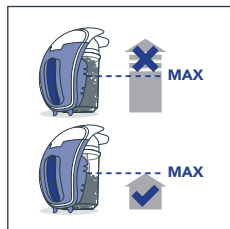

ODRŽAVANJE CYCLONE FILTRA

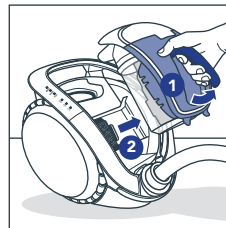
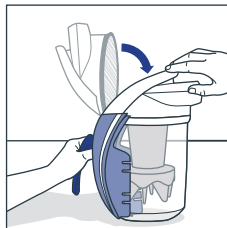
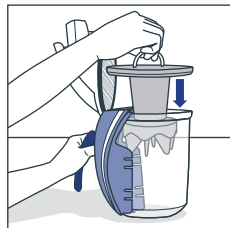
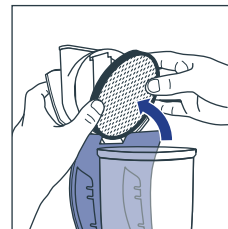
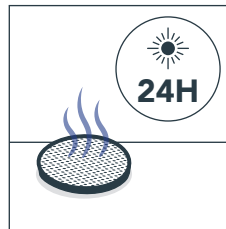
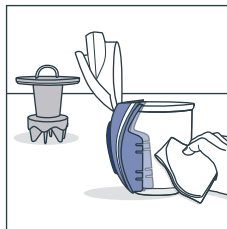
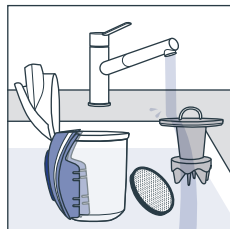

Cyclone filter operite vodom nakon svakog pražnjenja spremnika za prašinu. Mijenjajte ga jedanput godišnje. Za kupnju novoga pogledajte model Rowenta ZR007700

ODRŽAVANJE FILTRA MOTORA



JEDANPUT
MJESEČNO

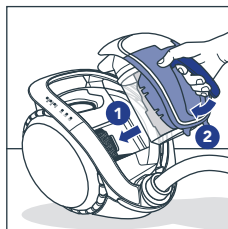
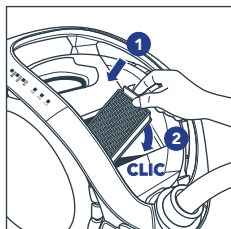
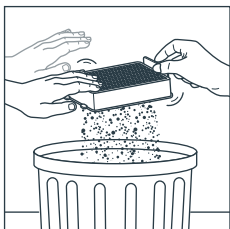
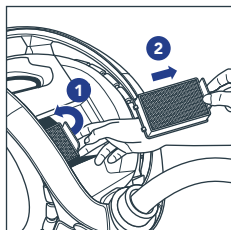
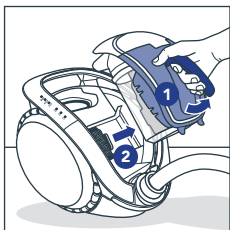

JEDANPUT
GODIŠNJE

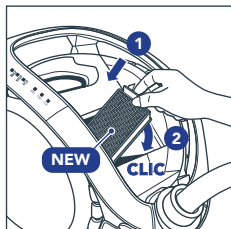
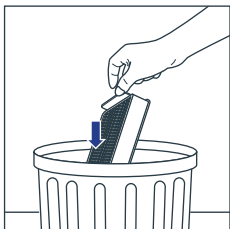

Filtar motora
mijenjajte jedanput
godišnje.

Za kupnju novoga
pogledajte model
Rowenta ZR007700.

ČIŠĆENJE MINI TURBO ČETKICE

Prije čišćenja uvijek skinite
mini turbo četkicu (dostupno u
određenim modelima).

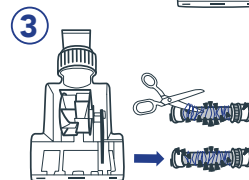
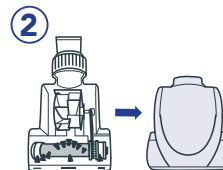

ODLAGANJE

OPCIJA 1

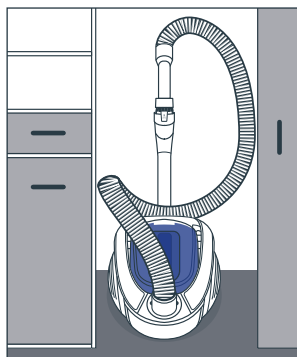
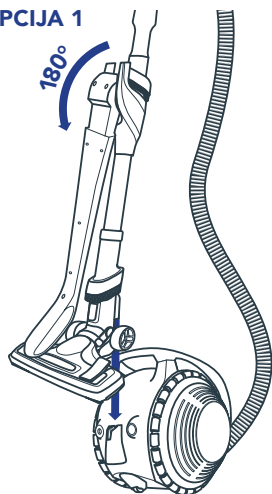

OPCIJA 2

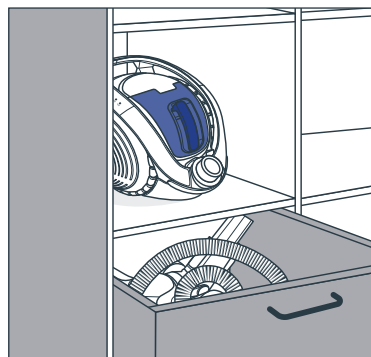
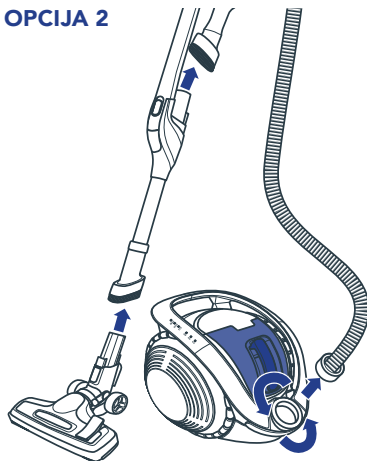

OPREZ

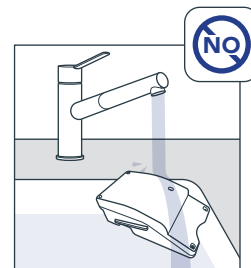

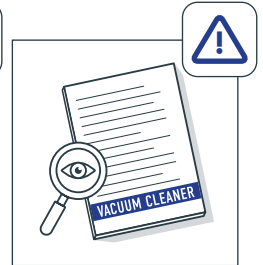
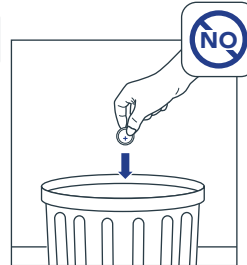
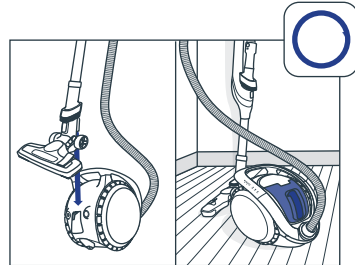
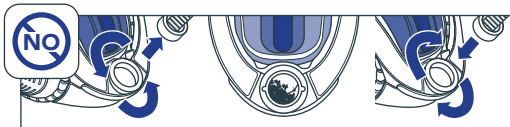
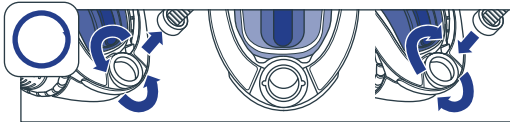
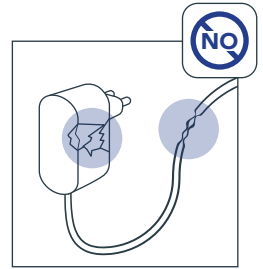
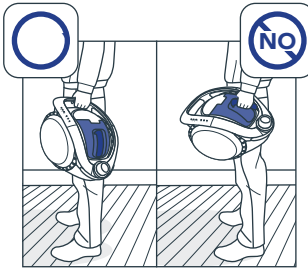
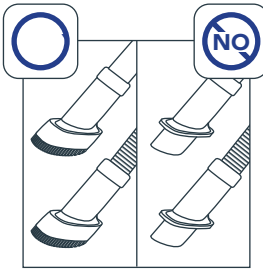
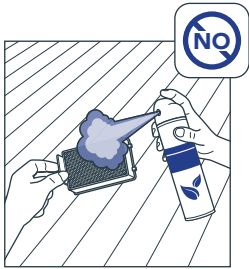
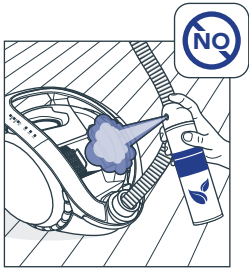
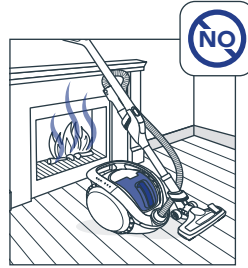
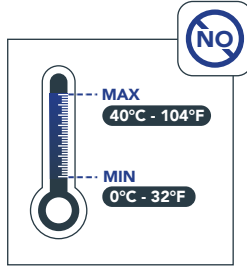



Hvala, da ste izbrali model Rowenta X-Ö. Aparat ima vgrajene najnovejše Rowentine tehnologije.

Priročnik natančno preberite, da boste lahko čim bolj izkoristili zmogljivosti svojega aparata.

Skenirajte s fotoaparatom telefona ali bralnikom kod QR in si oglejte koristen videoposnetek o sestavljanju naprave.



SESTAVLJANJE



Pozor! Pred prvo uporabo naredite naslednje; glejte stran 146.

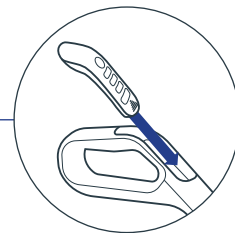
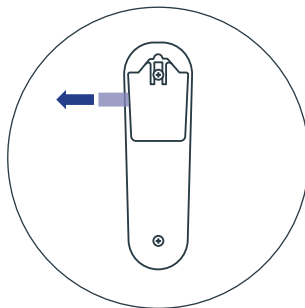

AKUMULATOR APARATA JE TREBA PRED PRVO UPORABO POVSEM NAPOLNITI

Napajalni kabel najprej priklopite na aparat, šele nato v električno vtičnico.

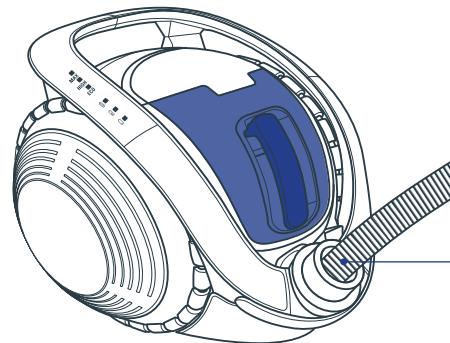
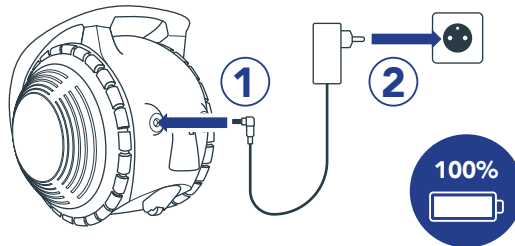

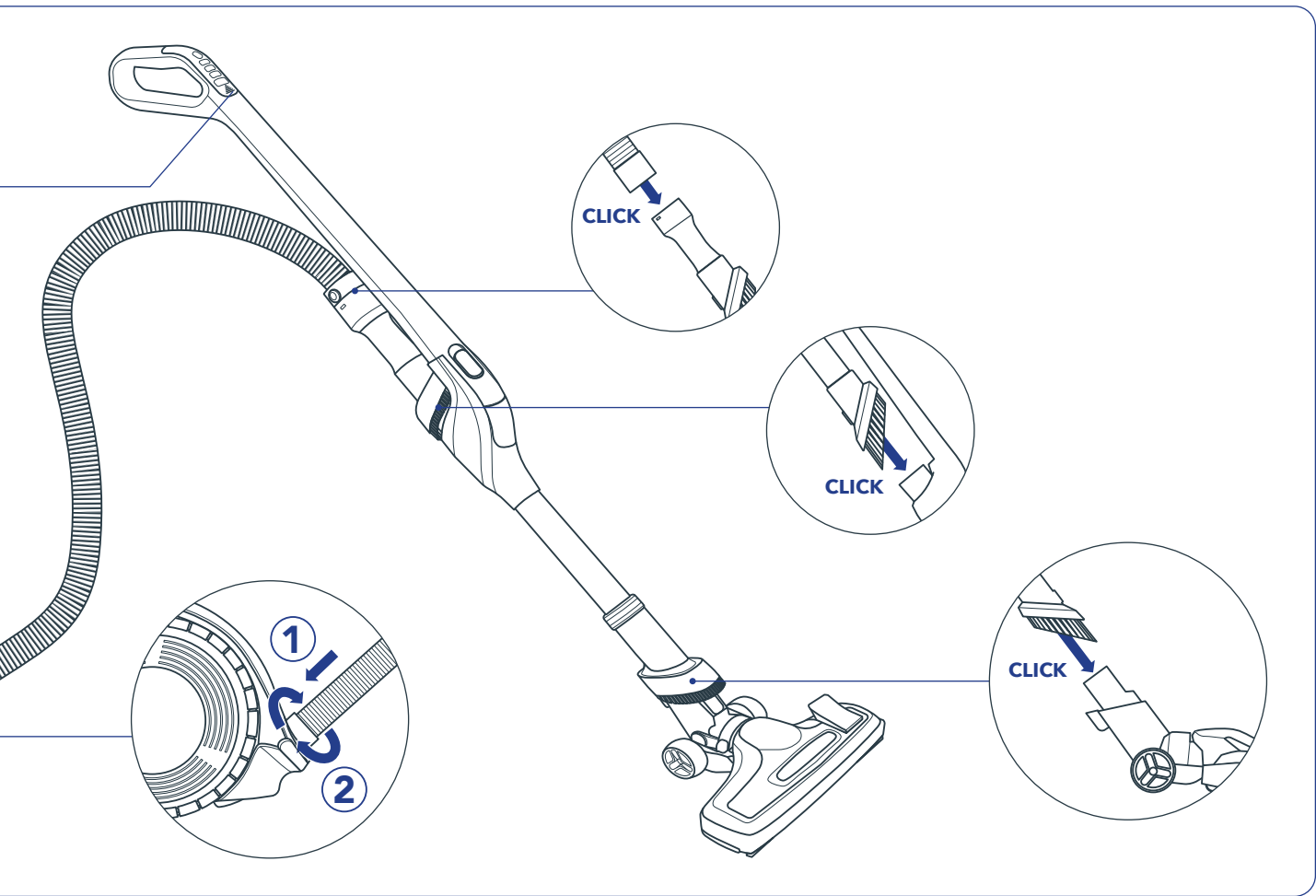

PRED PRVO UPORABO



Kako z aparatom seznaniti daljinski upravljalnik?



Pred prvo uporabo je treba daljinski upravljalnik seznaniti.

To je treba storiti le enkrat.

	Kaj morate storiti:	Kaj vidite na aparatu:
1	Pred prvo uporabo odstranite plastični jeziček.	
2	Vklopite aparat: Pritisnite gumb za vklop/izklop.	Modri LED-indikatorji akumulatorja svetijo.
3.1	Začnite postopek seznanitve: <u>Hkrati</u> pritisnite gumba MAX in II .	- Zaslíši se potrditveni pisk - Modri LED-indikatorji akumulatorja in zeleni indikatorji hitrosti izmenično utripajo
3.2	Potrdite seznanitev: <u>Takoj po</u> koraku 3.1 pritisnite gumb II . (dokler indikatorji LED izmenično utripajo)	- Modri indikatorji LED še vedno svetijo - Zaslíši se dvojni pisk Ce niti po 10 sekundah ne zaslišite dvojnega piska, seznanitev ni uspela. Izklopite aparat in začnite znova z 2. korakom.

➤ Čestitamo! Daljinski upravljalnik ste uspešno združili.

GUMB ZA VKLOP/IZKLOP

Za vklop ali izklop aparata kratko pritisnite gumb za vklop/izklop.

Za začetek sesanja pritisnite enega od gumbov za hitrost ECO, HIGH ali MAX na daljinskem upravljalniku.

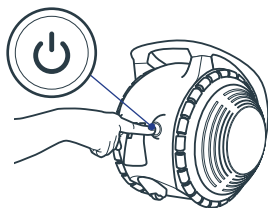

MOČ DELOVANJA

Aparat ima 4 načine moči delovanja. Načine čiščenja in moč delovanja lahko spreminjate z gumbi na daljinskem upravljalniku:

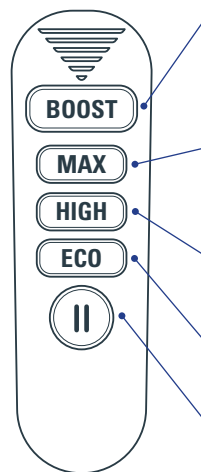

BOOST: 5 min/10 min*

Intenzivno čiščenje trdovratne umazanije.
UPOŠTEVAJTE: Za uporabo tega načina neprekinjeno držite gumb BOOST.

MAX: 20/40 min*

Intenzivno čiščenje in zasušena umazanija. Idealno na vseh vrstah preprog.

HIGH: 40/50/90 MIN*

Za redno ohranjanje čistoče. Idealno za vse vrste trdih tal.

ECO: 1h 10/1h 30/2h 40 min*

Za rahlo umazana tla in občutljive površine: police, okvirji, zavese itd.

PAUSE:

Začasen izklop med uporabo.

Lučke LED kažejo moč delovanja. V načinu BOOST vse tri lučke hkrati utripajo.

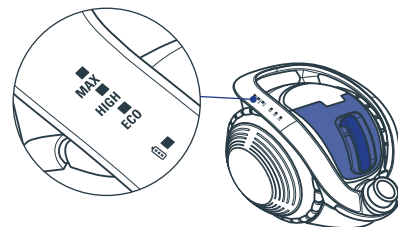

SESALNA ŠOBA

Šoba z dvema položajema je opremljena z nožnim stikalom, ki preklaplja med položajema za sesanje preprog in trdih tal.

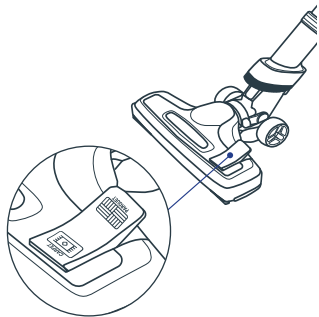

PARKET

Položaj za sesanje trdih tal, primeren za lesene parkete, ploščice, linolej itd.



PREPROGA

Položaj za sesanje preprog, idealen za globinsko sesanje vseh vrst preprog ali odej.

DALJINSKO UPRAVLJANJE

Aparat lahko upravljate z daljinskim upravljalnikom, ki se nahaja v ročaju. Napaja ga okrogla (gumb) baterija CR2032.

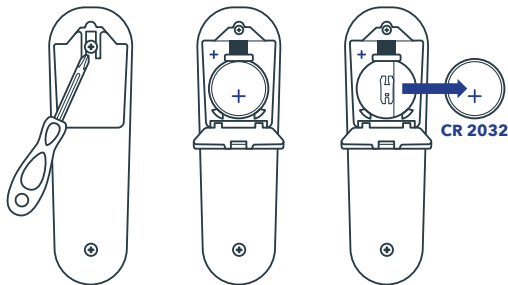

Priporočamo menjavo baterije vsakih 18 mesecev.

V primeru izgube ali okvare daljinskega upravljalnika lahko aparat še vedno vklopite z daljšim pritiskom gumba za vklop.

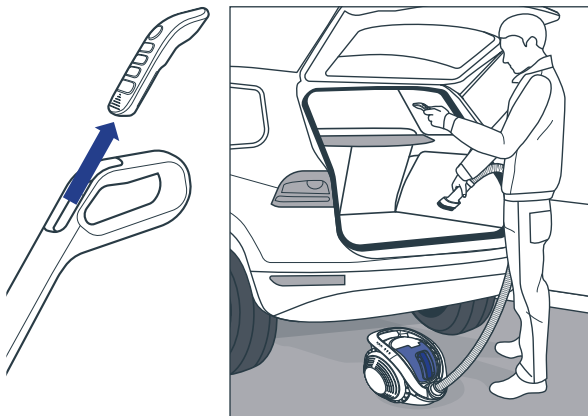

Daljinski upravljalnik lahko snamete in za čiščenje uporabljate samo upogljivo cev (kar je npr. idealno za čiščenje vozil).

Kako uporabljati
daljinski upravljalnik?



AKUMULATOR IN POLNENJE



POLNENJE AKUMULATORJA TRAJA 4 URE.

Za polnjenje aparata sta na voljo dve možnosti:

MOŽNOST 1

Polnilnik priklopite neposredno na sesalnik: najprej ga priklopite na sesalnik, nato v električno vtičnico.

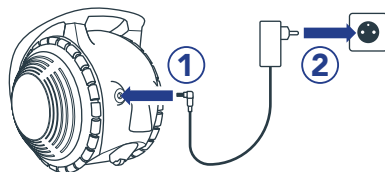

MOŽNOST 2

Polnilnik priklopite na akumulator. V ta namen akumulator odstranite iz aparata in polnilnik najprej priklopite nanj ter nato še v električno vtičnico.

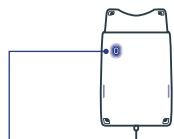
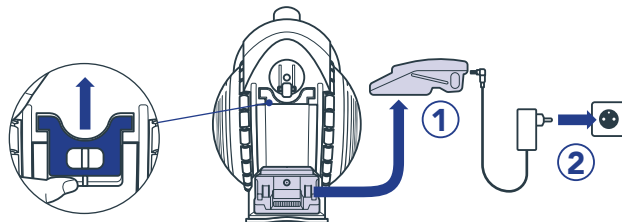

Modra lučka sveti:
polnjenje akumulatorja.

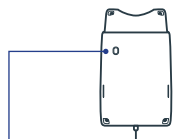

Modra lučka ne sveti:
akumulator je napolnjen.

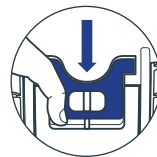
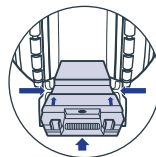

Odčitajte kodo za dodatne informacije o akumulatorju in polnjenju.



STANJE AKUMULATORJA

Aparat kaže stopnjo napoljenosti:

- 3 modre lučke LED svetijo: 100 % napolnjen.
- 2 modri lučki LED svetita: 60 % napolnjen.
- 1 modra lučka LED utripa: aparat je treba napolniti.

Če je akumulator povsem izprazen, 1 modra lučka LED nekajkrat utripne.

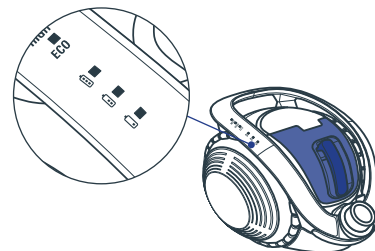

FUNKCIJA FLEX

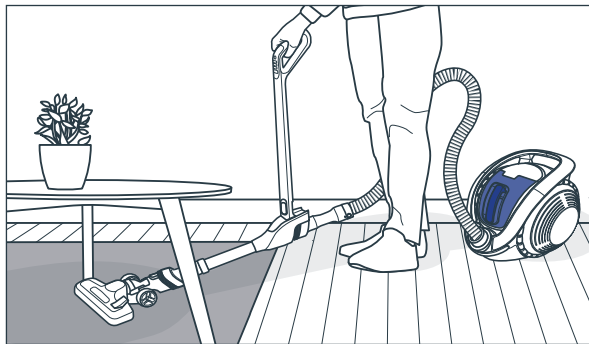

Aparat je opremljen s tehnologijo Flex. Z njo lahko brez težav dosežete tudi najbolj oddaljene koticke pod nizkim pohištvom.

Za aktivacijo potisnite gumb Flex navzgor.

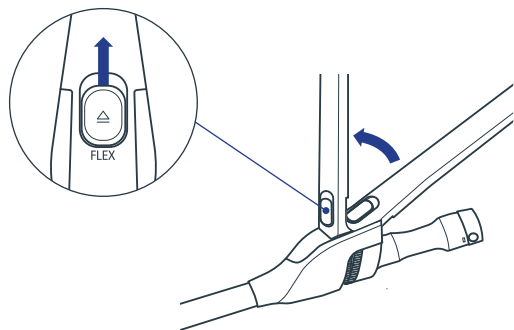

PRIKLJUČKI

Aparatu sta priloženi 2 krtači za preprosto sesanje prahu. Z njima lahko sesate prah z večine površin.

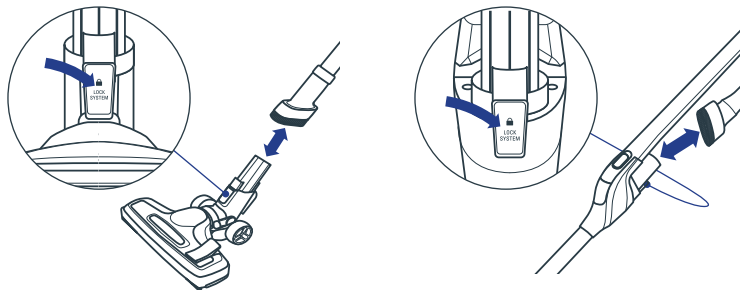

Pri čiščenju posameznih površin lahko uporabljate dodatne priključke: do konca jih vstavite v eno od cevi.

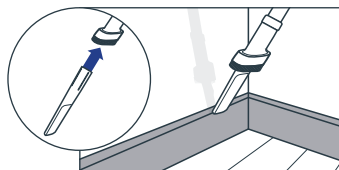

Z ozkim nastavkom lahko posesate težko dostopna mesta.

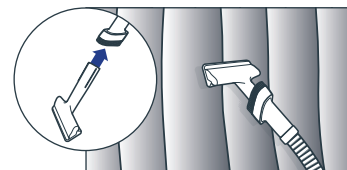

S krtačo za kavče lahko posesate težko dostopna mesta.

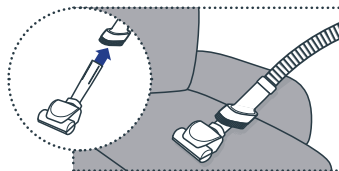

**Za globinsko sesanje foteljev, vzmetnic ali avtomobilskih preprog uporabljajte mini turbo krtačo z močjo delovanja MAX ali BOOST.

X-Ô

VZDRŽE- VANJE

Skenirajte s telefonom ali bralnikom kod QR in si za najučinkovitejše delovanje aparata pomagajte z nasveti za njegovo vzdrževanje.



PRAZNJENJE POSODE ZA PRAH

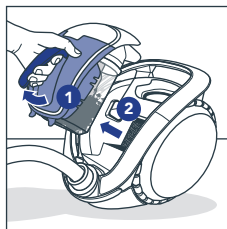
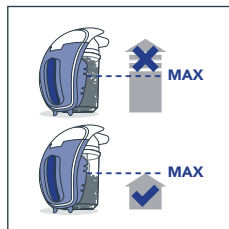

VZDRŽEVANJE KROŽNEGA FILTRA

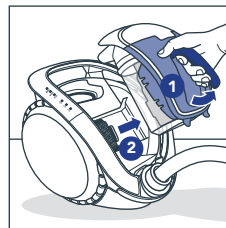
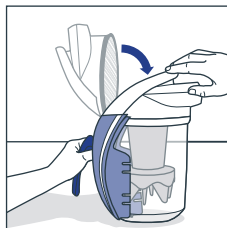
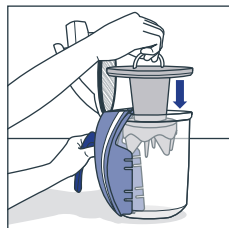
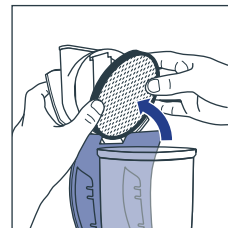
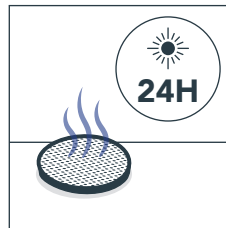
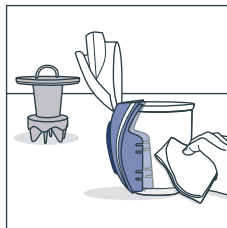
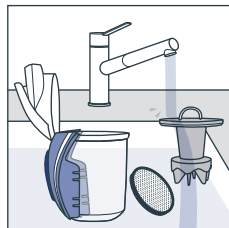

Krožni filter ob vsakem praznjenju posode za prah operite z vodo. Zamenjajte ga enkrat letno. Pri nakupu novega si pomagajte s številko artikla Rowenta ZR007700.

VZDRŽEVANJE FILTRA MOTORJA



1-KRAT
MESEČNO

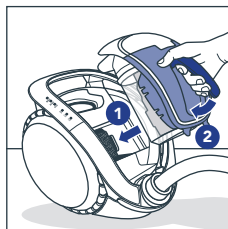
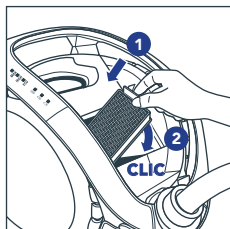
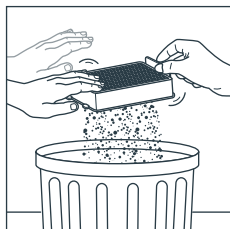
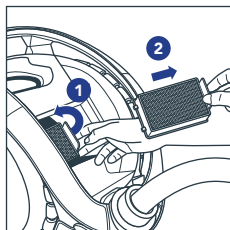
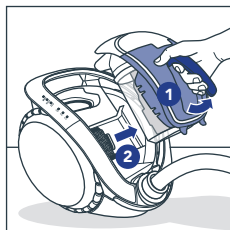

1-KRAT
LETNO

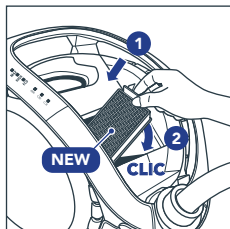
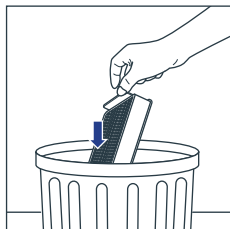

Filter motorja zamenjajte enkrat letno.

Pri nakupu novega si pomagajte s številko artikla Rowenta ZR007700.

ČIŠČENJE MINI TURBO KRTAČE

Mini turbo krtičo vedno snemite, preden jo očistite (na voljo pri nekaterih modelih).

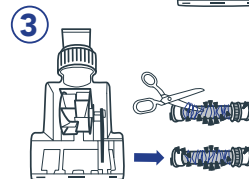
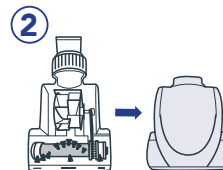

SHRANJEVANJE

MOŽNOST 1

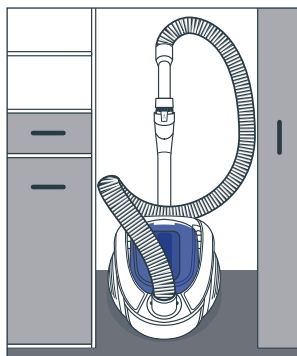
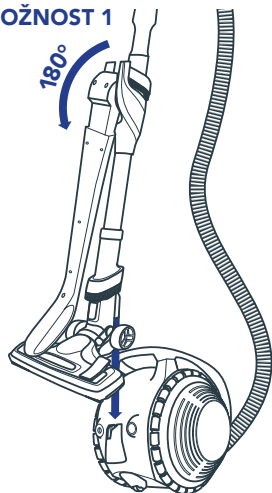

MOŽNOST 2

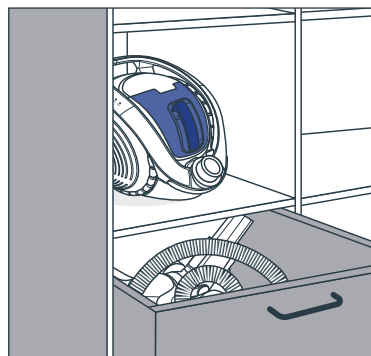
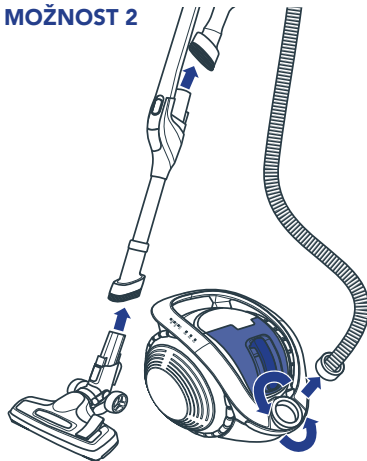

PREVIDNO

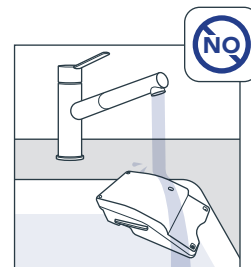
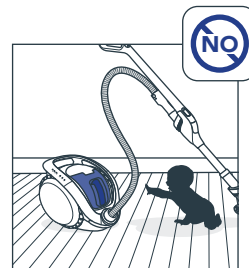

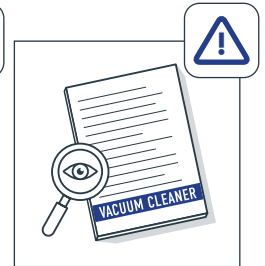
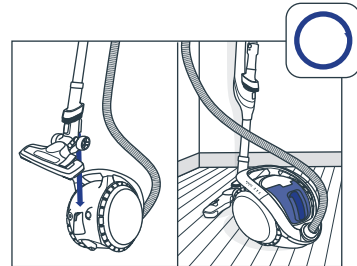
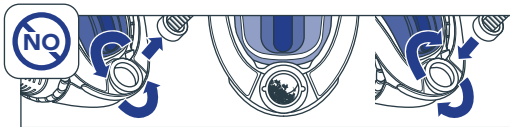
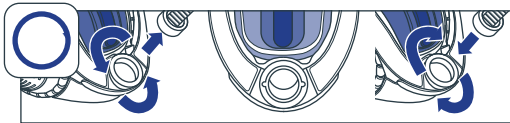
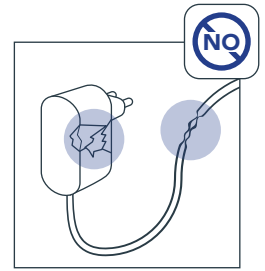
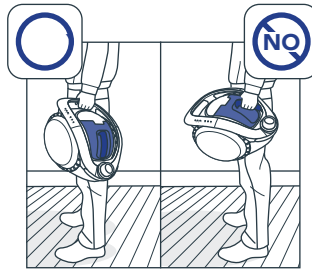
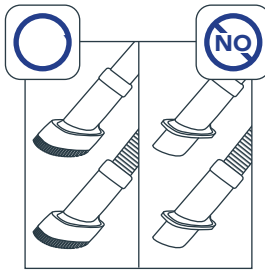
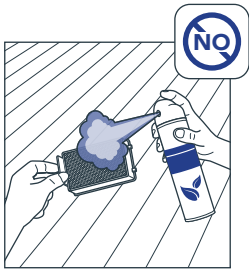
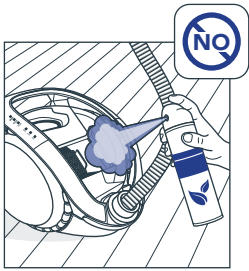
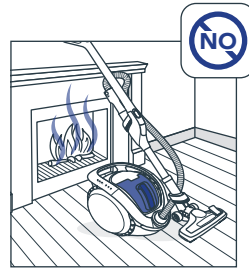
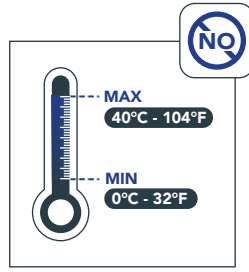



Hvala vam što ste izabrali da kupite Rowenta X-Ö.

Aparat je opremljen najnovijom Rowenta tehnologijom.

Pažljivo pročitajte uputstvo da biste na najbolji način iskoristili kapacitete uređaja.

Skenirajte kamerom telefona ili QR čitačem da biste pogledali koristan video vodič o tome kako da sastavite svoj uređaj.



MONTAŽA



Upozorenje! Treba preduzeti radnju pre prve upotrebe, pogledajte stranicu 156.

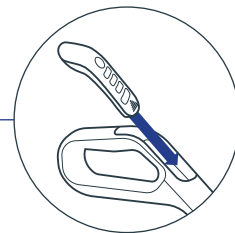
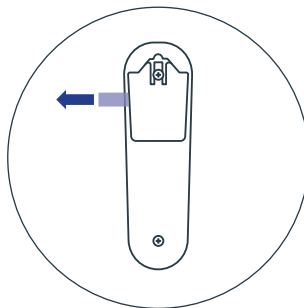

VAŠ UREĐAJ TREBA DA BUDE POTPUNO NAPUNJEN PRE PRVE UPOTREBE

Prvo povežite utičnicu pre uključivanja.

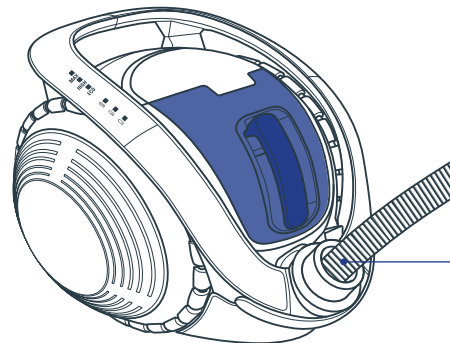
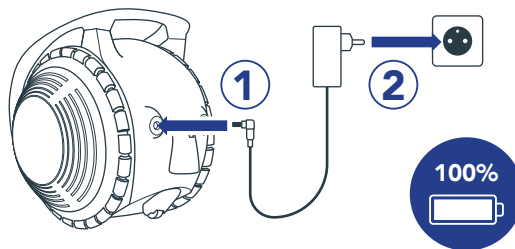

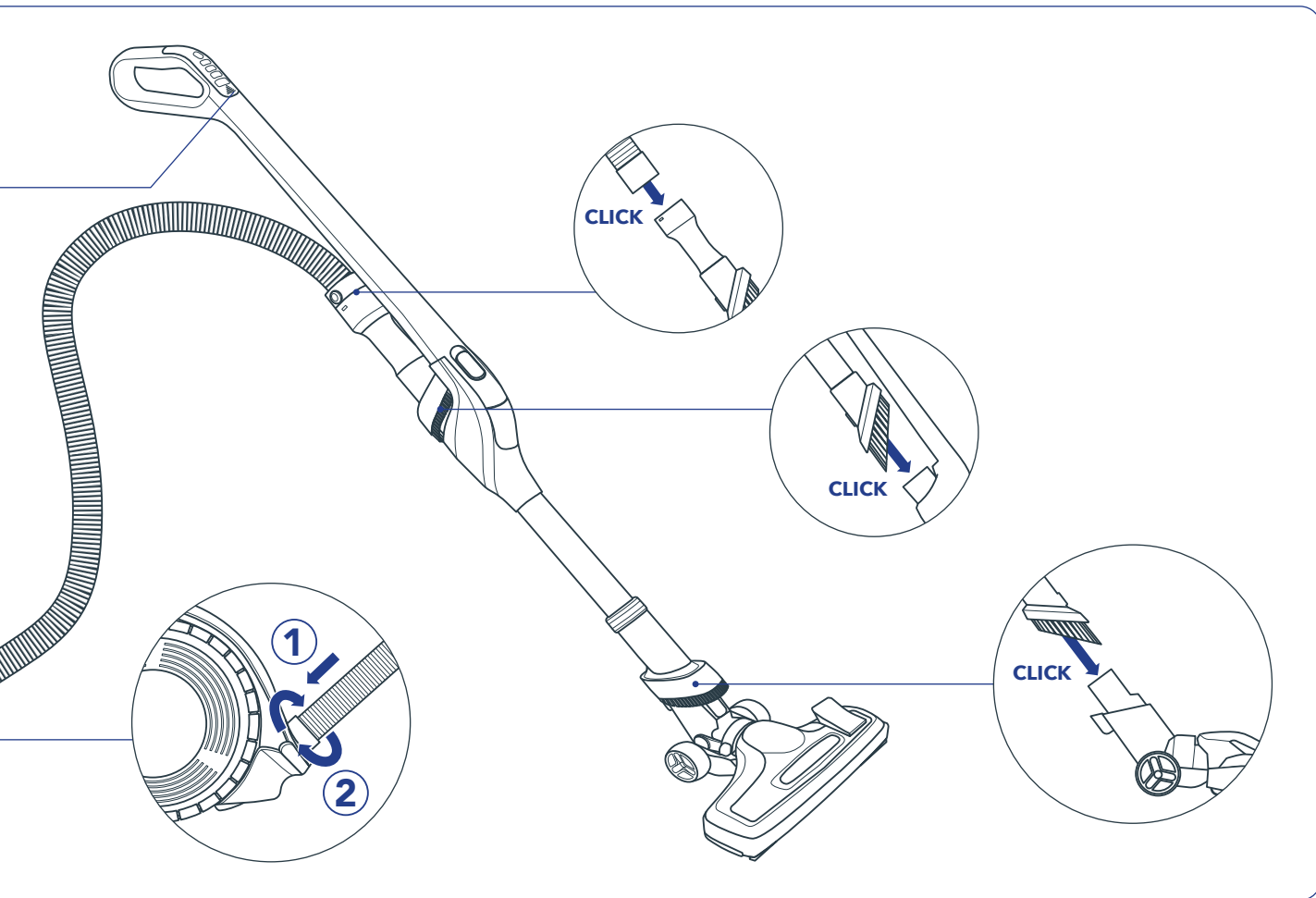

PRE PRVE UPOTREBE



Kako da uparim daljinski upravljač?



Uparite daljinski upravljač pre prve upotrebe.

Potrebno uraditi samo jednom.

	Šta treba da uradite:	Šta možete da vidite na uređaju:
1	Skinite plastični jezičak pre prve upotrebe.	
2	Uključite svoj uređaj: Pritisnite taster za uključivanje/isključivanje.	Upaljene su plave LED lampice baterije.
3.1	Pokrenite uparivanje: Pritisnite <u>istovremeno</u> tastere MAX i II .	- Čućete zvuk potvrde - Plave LED lampice baterije i zeleni LED indikatori brzine alternativno trepere
3.2	Potvrdite uparivanje: Pritisnite <u>odmah posle</u> koraka 3.1 na dugmetu II . (Dok LED lampice alternativno trepere)	- Upaljene su plave LED lampice - Čućete dvostruki zvuk Ako ne čujete dvostruki zvuk posle 10 sekundi: uparivanje nije uspelo. Isključite aparat i počnite ponovo od koraka 2.

> Čestitamo! Uspješno ste uparili daljinski upravljač.

TASTER ZA UKLJUČIVANJE/ISKLJUČIVANJE

Da biste uključili i isključili svoj uređaj, kratko pritisnite taster za napajanje.

Da biste započeli usisavanje, pritisnite ECO, HIGH ili MAX brzinu na daljinskom upravljaču.

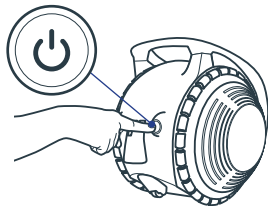

REŽIM NAPAJANJA

Vaš aparat ima 4 režima napajanja. Promenite režime čišćenja pomoću tastera na daljinskom upravljaču i podesite snagu:

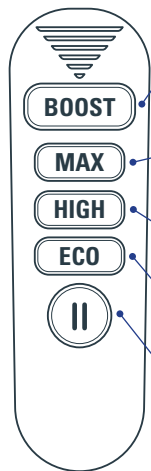

BOOST: 5 min/10 min*

Intenzivno čišćenje za prljavštinu na podu.

NB: Nastavite da pritisnete taster POJAČAVANJE da biste koristili ovaj režim.

MAX: 20/40 min*

Intenzivno čišćenje i obložena prašina. Idealno za sve tipove tepiha.

HIGH: 40/50/90 min*

Za čišćenje pri održavanju. Idealno za sve tipove tvrdih podova.

ECO: 1h10/1h30/2h40min*

Za slabo zaprljane podove i osetljive površine: police, ramovi, zavese itd.

PAUSE:

Privremeno isključivanje tokom upotrebe.

LED lampice označavaju režime napajanja. U BOOST režimu, sve tri zelene lampice će istovremeno svetleti.

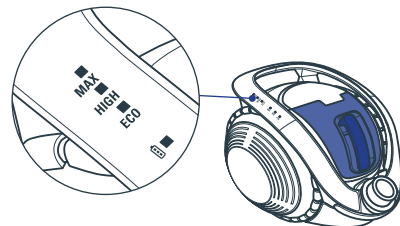

*u zavisnosti od modela.

USISNA GLAVA

Vaša usisna glava sa dva položaja je opremljena tasterom koji vam omogućava da menjate položaj tepiha ili tvrdog poda.

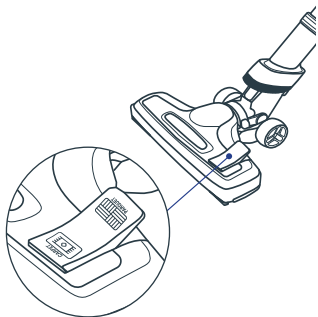

PARKET

Položaj za čvrste podove, kompatibilan sa drvenim parketom, pločicama, linoleumom itd.



TEPIH

Položaj za tepihe, savršen za dubinsko usisavanje bilo kog tepiha ili staze.

DALJINSKI UPRAVLJAČ

Vašim uređajem se upravlja pomoću daljinskog upravljača, integrisanog u ručku. Napaja ga okrugla baterija tipa CR2032.

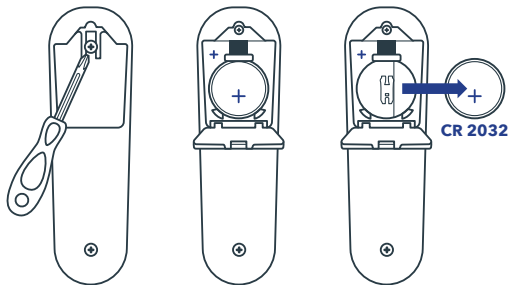

Savetujemo vam da menjate bateriju svakih 18 meseci.

U slučaju gubitka ili oštećenja daljinskog upravljača, i dalje možete uključiti svoj uređaj dugim pritiskom na taster ON

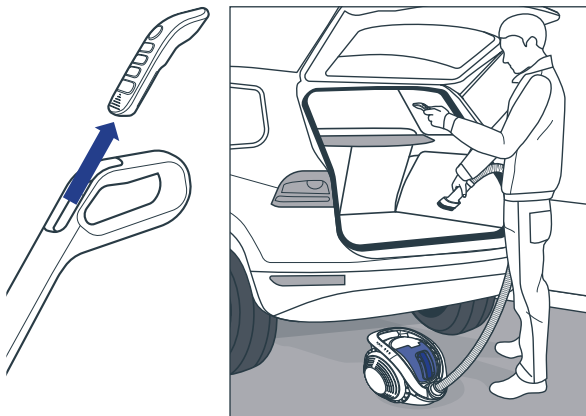

Možete da odvojite daljinski upravljač da biste obavljali sve svoje sesije čišćenja samo pomoću fleksibilnog creva (idealno za čišćenje vašeg automobila, na primer).

Kako da koristim daljinski upravljač?



BATERIJA I PUNJENJE



KOMPLETNO PUNJENJE BATERIJE TRAJE 4 SATA.

Da biste napunili svoj uređaj, imate izbor između dve opcije:

OPCIJA 1

Povežite punjač direktno sa usisivačem: prvo umetnite priključak, a zatim uključite.

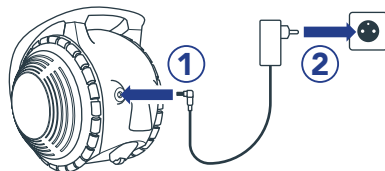

OPCIJA 2

Povežite punjač sa baterijom. Da biste to uradili, uklonite bateriju iz uređaja, ubacite priključak, a zatim uključite punjač.

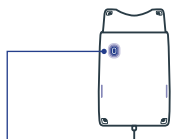
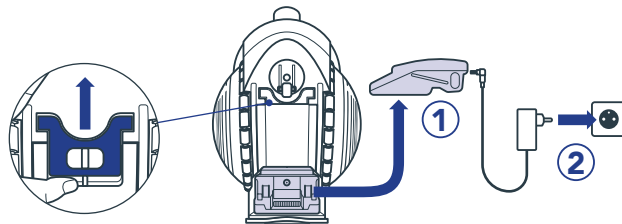

Plavo svetlo uključeno:
baterija se puni.

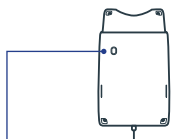

Plavo svetlo isključeno:
baterija je napunjena.

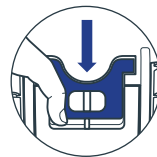
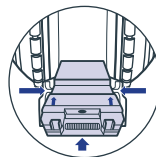

Skenirajte da biste saznali više
o bateriji i njenom punjenju.



STATUS BATERIJE

Vaš uređaj označava nivo punjenja:

- 3 plave LED lampice svetle: 100% napunjena.
- 2 plave LED lampice svetle: 60% napunjena.
- 1 plava LED lampica treperi: uređaj treba da se napuni.

Ako je baterija potpuno prazna, 1 plava LED lampica treperi nekoliko puta.

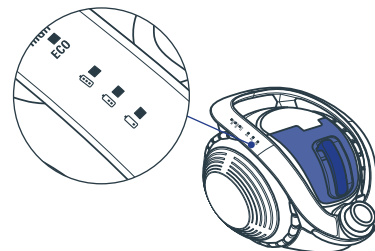

FUNKCIJA FLEX

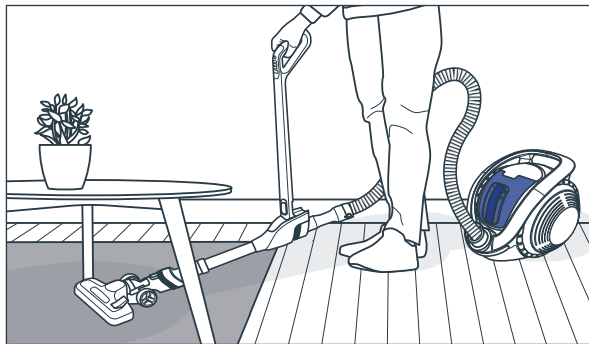

Aparat je opremljen Flex tehnologijom. Omogućava vam da bez napora dođete do najudaljenijih područja ispod nameštaja niske visine.

Da biste ga aktivirali, povucite taster Flex nagore.

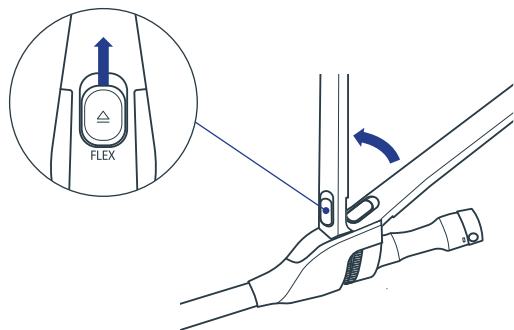

DODACI

Vaš aparat ima 2 integrisane Easy Dusting četkice. Možete ih koristiti za usisavanje većine površina.

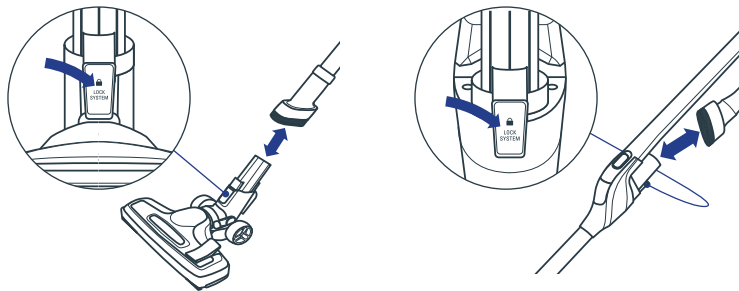

Za čišćenje određenih područja koristite dodatnu opremu: umetnite ih u jednu od cevi na maksimalnoj dubini.

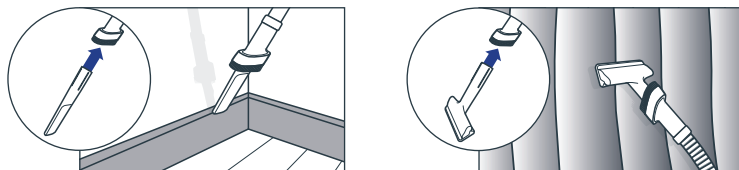

Koristite dodatak za uske otvore za usisavanje teško dostupnih mesta.

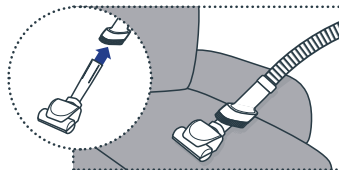

Koristite dodatak za tapacirane površine da usisavate tekstil kao što su sofa, zavese ili dušek.

**Koristite mini turbo četku u režimu MAX ili BOOST da dubinski usisavate sofe, duške ili patosnice.

X-Ô

ODRŽAVANJE

Skenirajte telefonom ili QR čitačem da biste na najbolji način iskoristili savete o održavanju za najbolji učinak.



PRAŽNENJE POSUDE ZA PRAŠINU

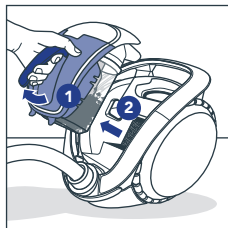
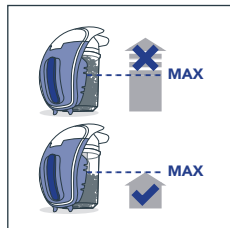

ODRŽAVANJE CIKLON FILTERA

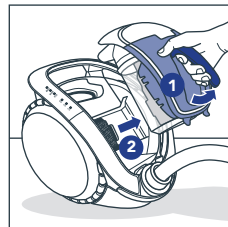
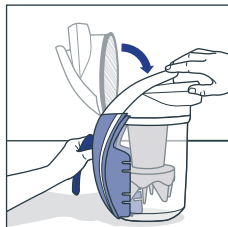
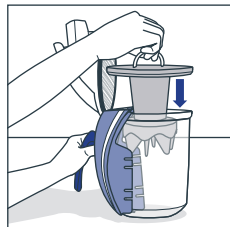
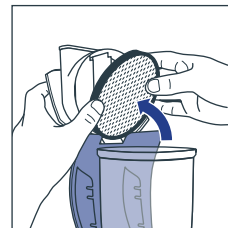
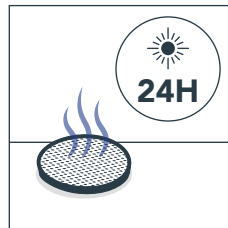
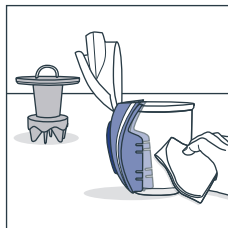
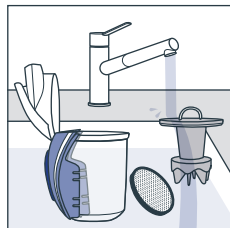

Operite ciklon filter vodom nakon svakog pražnjenja posude za prašinu. Zamenite jednom godišnje. Da biste kupili novi, potražite referencu Rowenta ZR007700.

ODRŽAVANJE FILTERA MOTORA



1X
MESEČNO

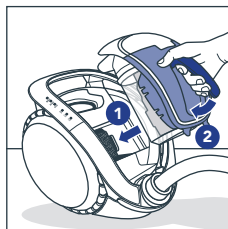
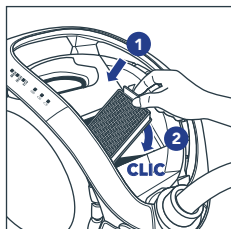
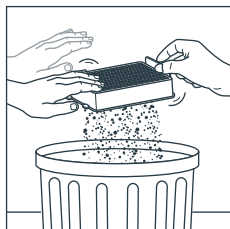
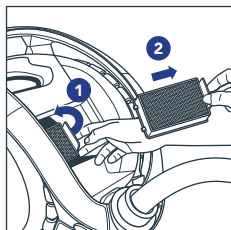
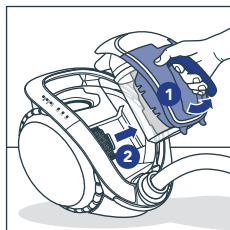

1X
GODIŠNJE

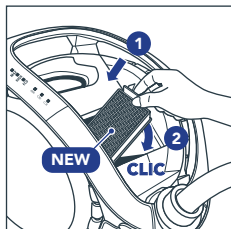
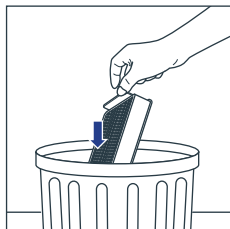

Zamenite filter motora jednom godišnje.

Da biste kupili novi, potražite referencu Rowenta ZR007700.

ČIŠĆENJE MINI TURBO ČETKE

Uvek skinite Mini Turbo četku pre čišćenja (dostupno na nekim modelima).

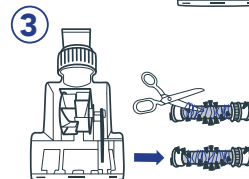
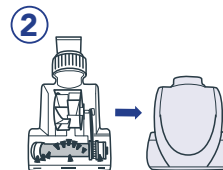

ODLAGANJE

OPCIJA 1

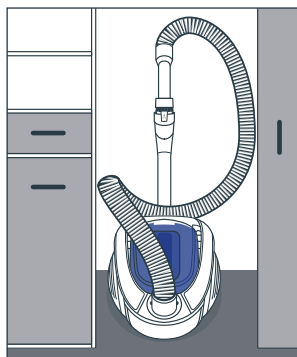
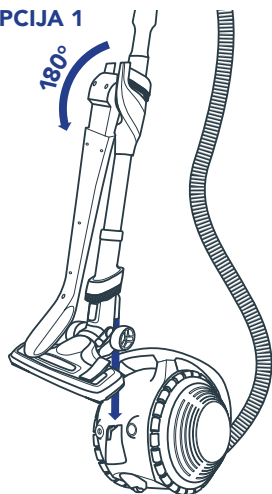

OPCIJA 2

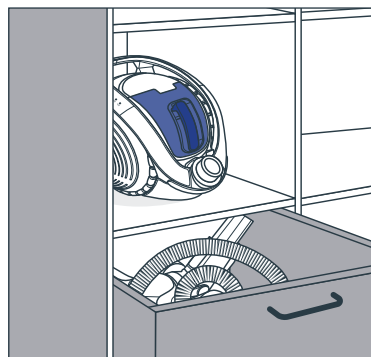
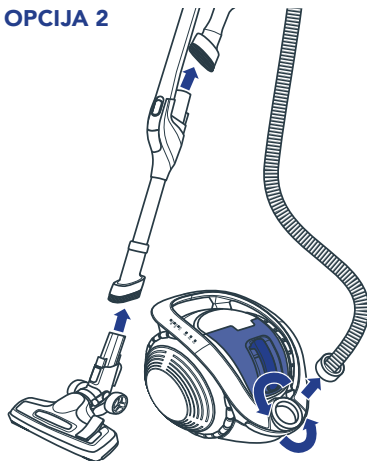

OPREZ

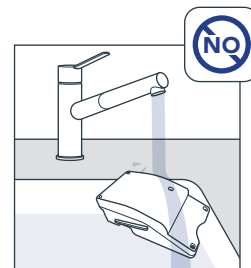

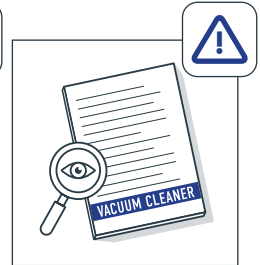
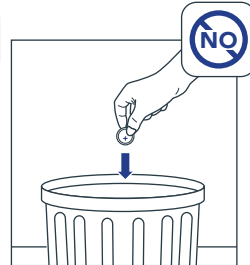
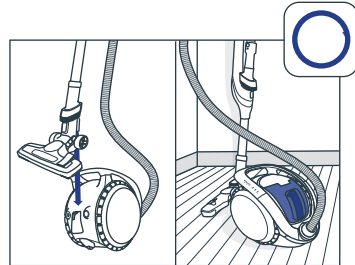
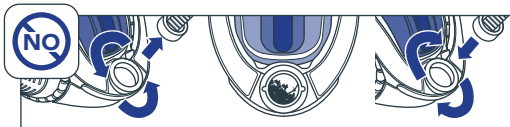
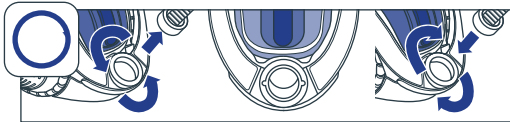
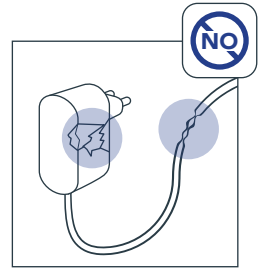
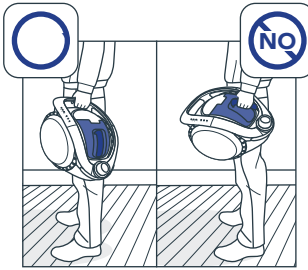
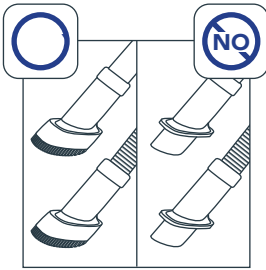
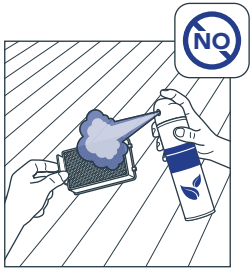
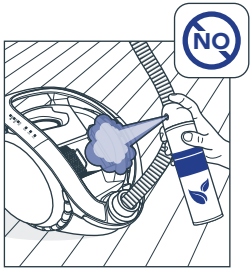
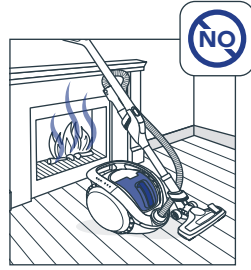
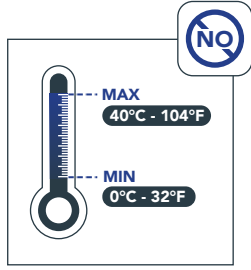



Hvala vam što ste izabrali kupiti Rowenta X-Ö.

U vaš aparat su ugrađene najnovije Rowenta tehnologije.

Pažljivo pročitajte ovo uputstvo da biste na najbolji način iskoristili mogućnosti svojeg aparata.

Skenirajte kamerom na telefonu ili QR čitačem da biste pogledali koristan video vodič o sastavljanju aparata.



SASTAVLJANJE



Upozorenje! Upute o tome što treba uraditi prije prve upotrebe potražite na strani 166.

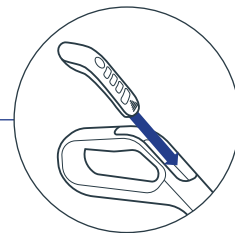
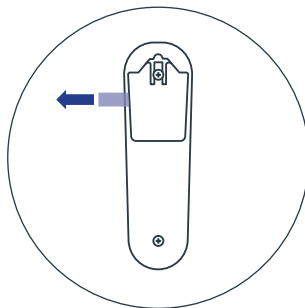

APARAT TREBATE DO KRAJA NAPUNITI PRIJE PRVE UPOTREBE

Prije uključivanja priključite utikač.

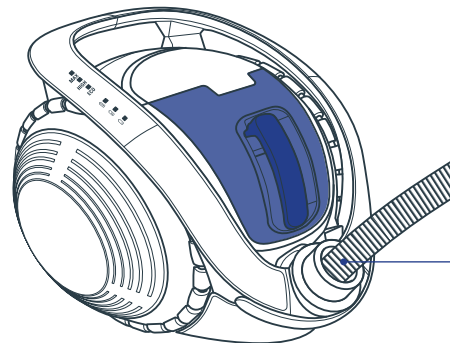
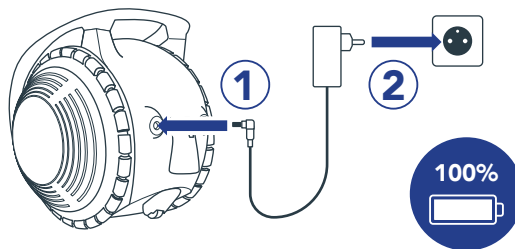

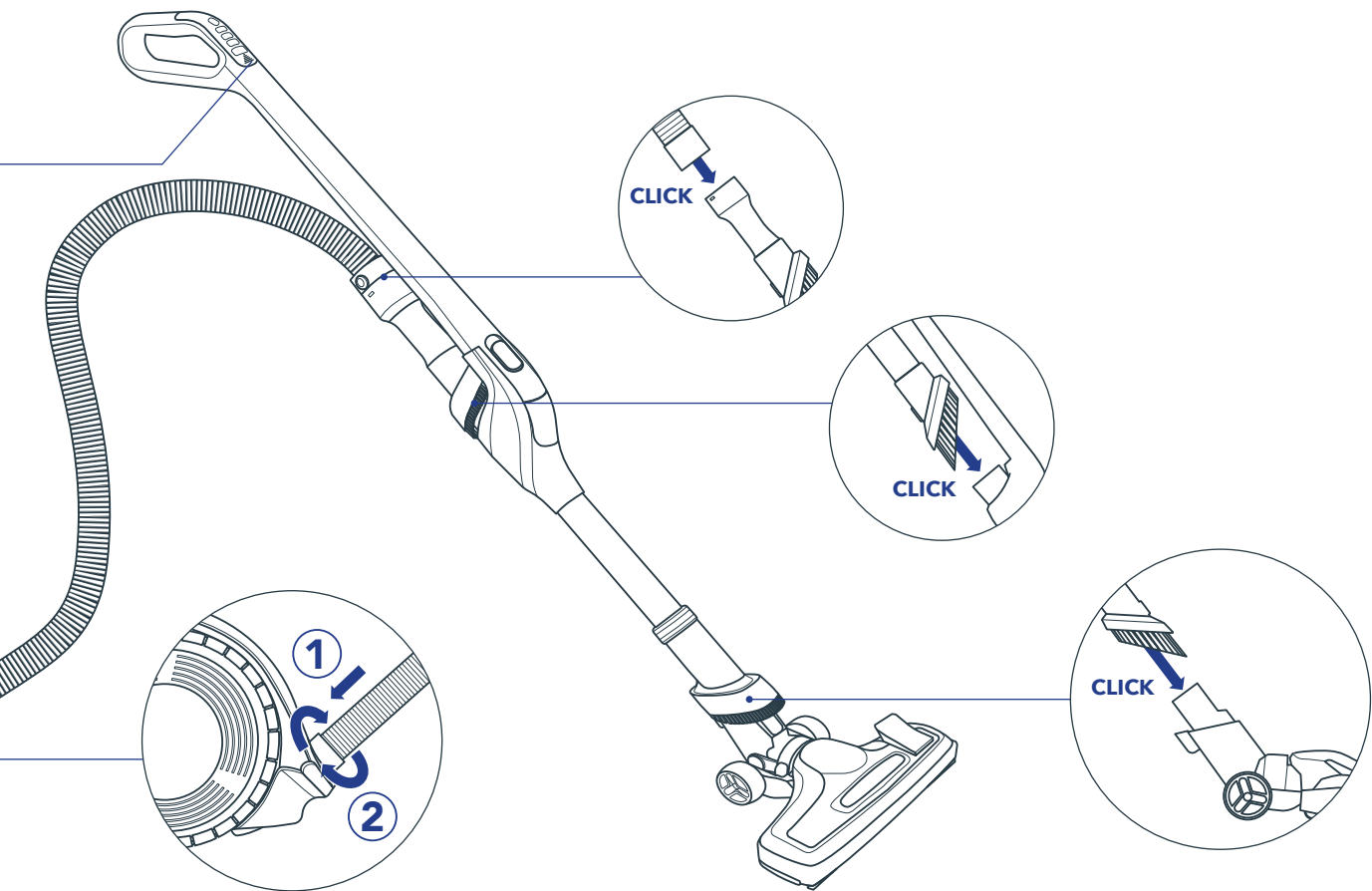

PRIJE PRVE UPOTREBE



Kako da uparim daljinski upravljač?



Daljinski upravljač uparite prije prve upotrebe.

Ovo treba uraditi samo jednom.

	Što trebate uraditi:	Što ćete vidjeti na aparatu:
1	Prije prve upotrebe skinite plastični ježicač.	
2	Uključite aparat: Pritisnite tipku za uključivanje/isključivanje.	Plavi LED indikatori za bateriju će svijetliti.
3.1	Pokrenite uparivanje: <u>Istovremeno pritisnite tipke</u> MAX i II .	- Čuti ćete zvučni signal potvrde - Plavi LED indikator za bateriju i zeleni LED indikator za brzinu naizmjenično trepere
3.2	Potvrdite uparivanje: Odmah nakon koraka 3.1 pritisnite tipku II . (dok LED indikatori naizmjenično trepere)	- Uključuju se plavi LED indikatori - Čuti ćete dvostruki zvučni signal Ako nakon 10 sekundi niste čuli dvostruki signal: uparivanje nije uspješno. Isključite aparat i počnite ispočetka od 2. koraka.

➤ Čestitamo! Uspješno ste uparili daljinski upravljač.

TIPKA ZA UKLJUČIVANJE/ISKLUČIVANJE

Da biste uključili i isključili svoj uređaj, kratko pritisnite dugme za napajanje.

Da biste počeli usisavati, na daljinskom upravljaču pritisnite brzinu ECO, HIGH ili MAX.

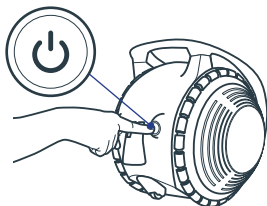

NAČIN ZA SNAGU

Aparat ima 4 načina za snagu. Promijenite načine čišćenja pomoću tipki na daljinskom upravljaču i podesite snagu:

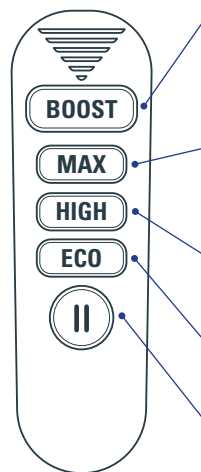

BOOST: 5min/10min*

Intenzivno čišćenje tvrdokorne prašine.

Napomena: Nastavite pritisnati tipku BOOST da biste koristili ovaj način.

MAX: 20/40min*

Intenzivno čišćenje i tvrdokorna prašina. Idealno za sve vrste tepiha.

HIGH: 40/50/90min*

Za čišćenje zbog održavanja. Idealno za sve vrste tvrdih podova.

ECO: 1h10/1h30/2h40min*

Za malo uprljane podove i njezne površine: police, okvire, zavjese itd.

PAUSE:

Privremeno isključivanje tokom upotrebe.

LED indikatori označavaju načine za snagu.

U načinu BOOST sva tri zelena indikatora istovremeno trepere.

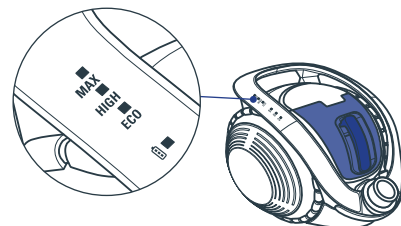

USISNA MLAZNICA

Vaša dvopozicijska mlaznica ima prekidač koji vam omogućava da se sa položaja za tepihe prebacite na onaj za tvrde podove.

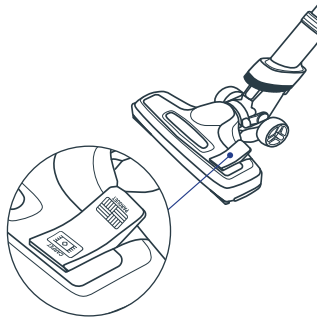

PARKET

Položaj za tvrde podove, koristi se za drvene parkete, pločice, linoleum itd.



TEPIH

Položaj za tepihe, savršen za dubinsko usisavanje svih tepiha i čilima.

DALJINSKI UPRAVLJAČ

Aparatom se upravlja daljinskim upravljačem koji je integriran u dršci. Napajanje je preko okrugle baterije CR2032.

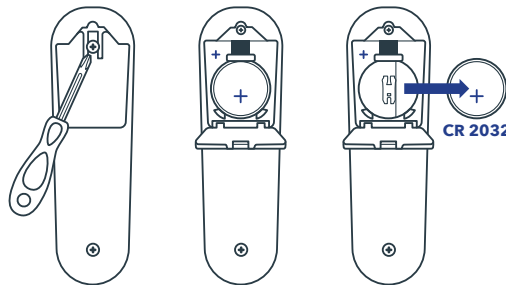

Savjetujemo da bateriju promijenite svakih 18 mjeseci.

Ako izgubite daljinski upravljač ili se on ošteti, aparat ćete i dalje moći uključiti tako da dugo pritisnete tipku za uključivanje

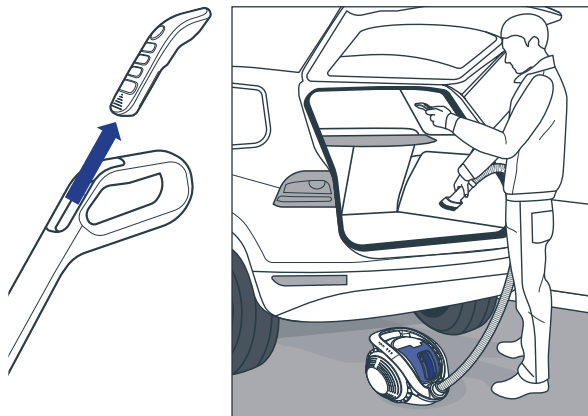

Možete odvojiti daljinski upravljač da biste čišćenje obavili samo pomoću savitljivog crijeva (idealno, na primjer, za čišćenje automobila).

Kako koristiti daljinski upravljač?



BATERIJA I NAPAJANJE



POTPUNO PUNJENJE BATERIJE TRAJE 4 SATA.

Za punjenje aparata možete izabrati jednu od dvije opcije:

OPCIJA 1

Direktno priključite punjač na usisivač; najprije umetnite utikač, zatim uključite.

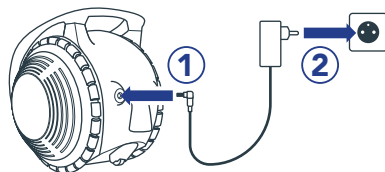

OPCIJA 2

Priključite punjač na bateriju. To uradite tako da izvadite bateriju iz aparata, umetnete utikač, a zatim uključite punjač.

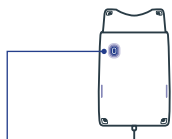
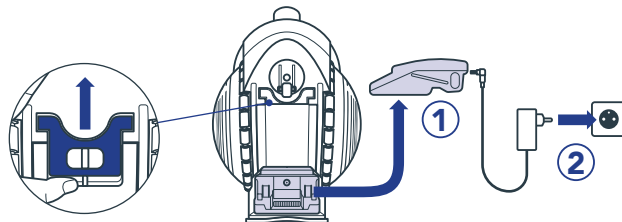

Plavi indikator svijetli:
baterija se puni.

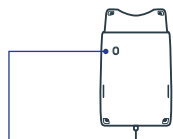

Plavi indikator ne
svijetli: baterija je
napunjena.

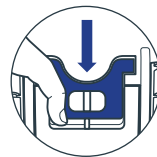
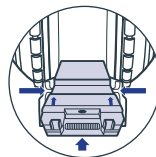

Skenirajte da biste saznali
više o bateriji i punjenju.



STATUS BATERIJE

Aparat pokazuje nivo napunjenosti:

- 3 plava LED indikatora svijetle: 100% napunjen.
- 2 plava LED indikatora svijetle: 60% napunjen.
- 1 plavi LED indikator treperi: aparat treba napuniti.

Ako je baterija potpuno prazna, 1 plavi LED indikator nekoliko će puta zatreperiti.

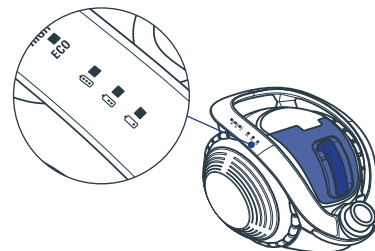

FLEX FUNKCIJA

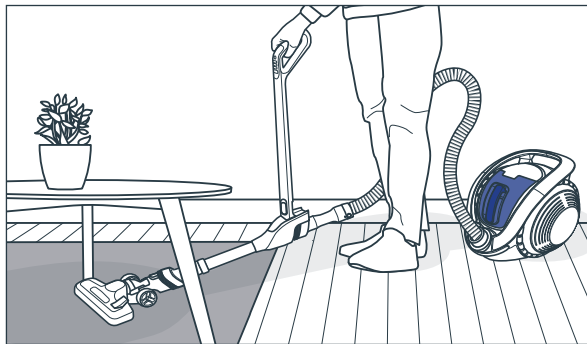

U aparat je ugrađena Flex tehnologija. Ona omogućava da bez problema dođete do udaljenih dijelova ispod niskog namještaja.

Da biste je aktivirali, povucite Flex tipku prema gore.

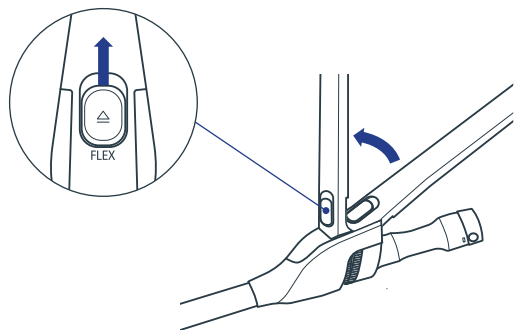

PRIBOR

Uz aparat se dobivaju 2 integrisane četke za jednostavno čišćenje. Njima možete usisavati većinu površina.

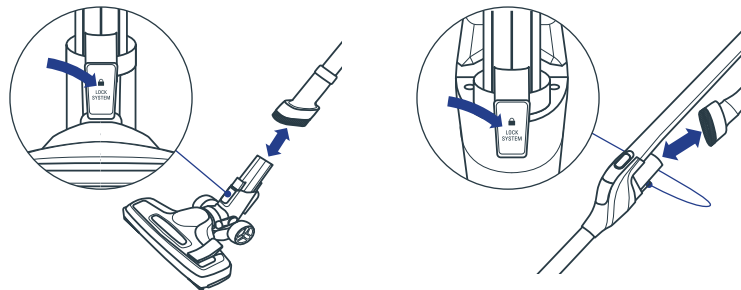

Ako trebate očistiti posebnu vrstu površine, koristite dodatke: umetnite ih u jednu od cijevi na maksimalnoj dubini.

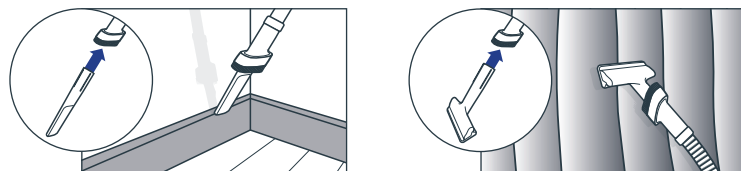

Alatom za uske prostore usisavajte mjesta koja su teško dostupna.

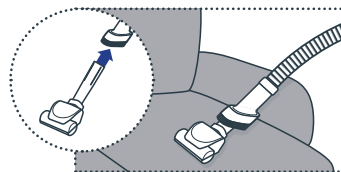

Četkom za namještaj usisavajte tekstile kao što su oni na sofi, zavjese ili madrace.

**Mini turbo četku koristite u načinu MAX ili BOOST da biste dubinski usisali sofe, madrace ili tepihe u automobilu.

X-Ô

ODRŽAVANJE

Skenirajte pomoću telefona ili QR čitača da biste dobili savjete za održavanje i najbolji način korištenja.



PRAŽNENJE SPREMNIKA ZA PRAŠINU- ISPRAZNITE SPREMNIK ZA PRAŠINU.

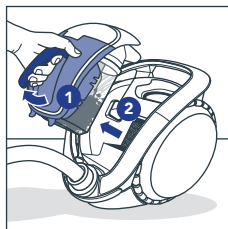
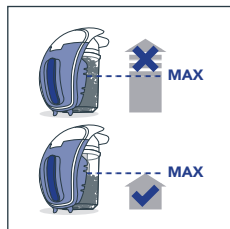

ODRŽAVANJE CIKLONSKOG FILTERA

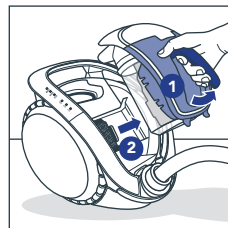
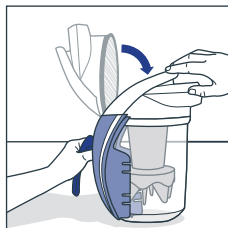
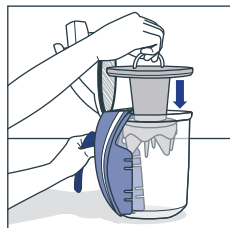
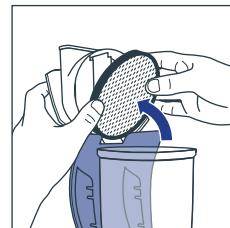
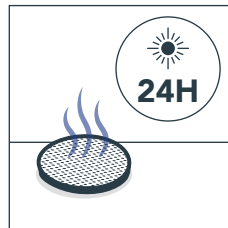
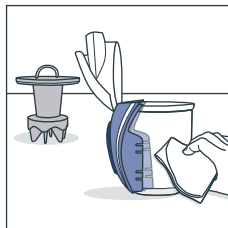
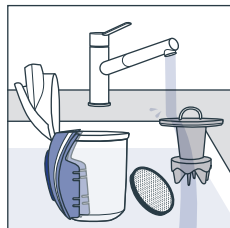

Ciklonski filter operite pod vodom nakon pražnjenja spremnika za prašinu. Zamijenite ga jednom godišnje. Ako želite kupiti novi, tražite model Rowenta ZR007700.

ODRŽAVANJE FILTERA ZA MOTOR

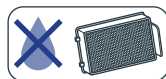

1X
MJESEČNO

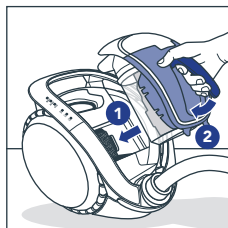
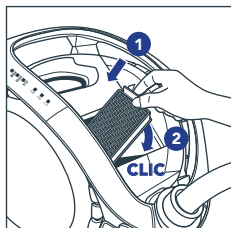
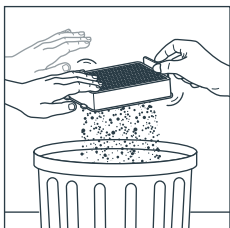
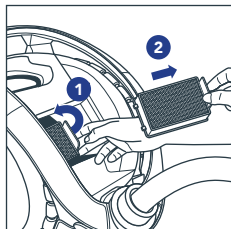
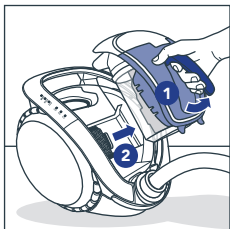

1X
GODIŠNJE

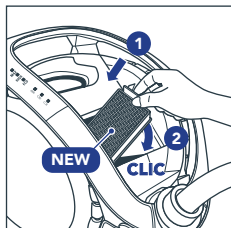
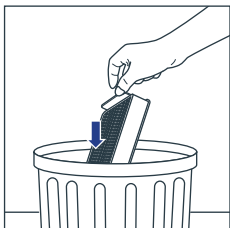

Filter za motor zamijenite jednom godišnje. Ako želite kupiti novi, tražite model Rowenta ZR007700.

ČIŠĆENJE MINI TURBO ČETKU

Uvijek izvadite mini turbo četku prije čišćenja (dostupna za neke modele).

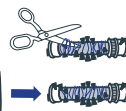
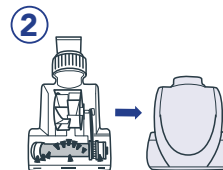

ODLAGANJE

OPCIJA 1

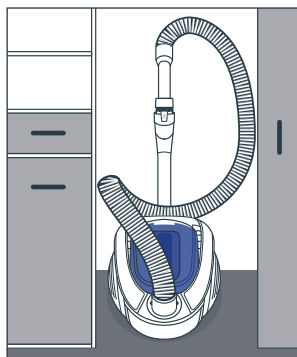
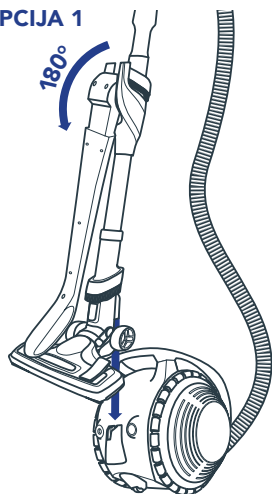

OPCIJA 2

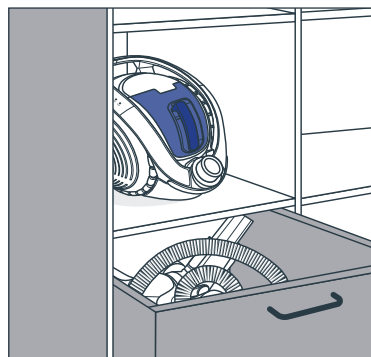
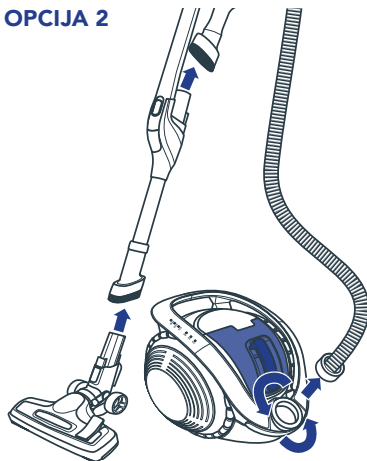

OPREZ

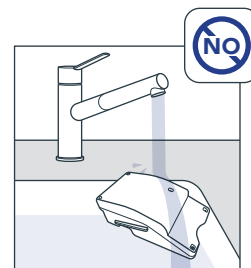

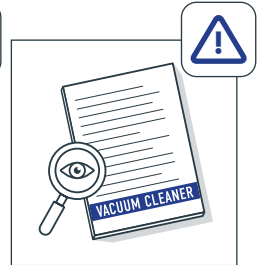
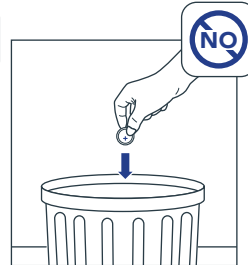
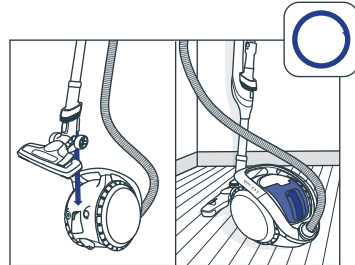
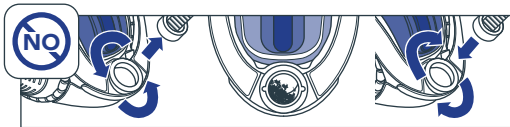
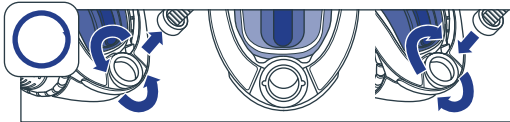
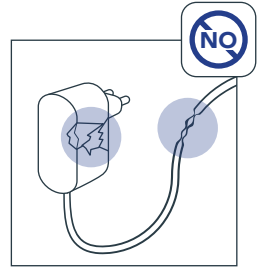
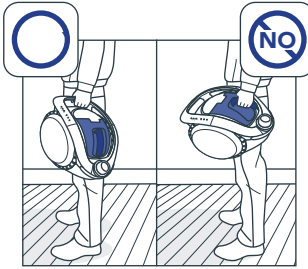
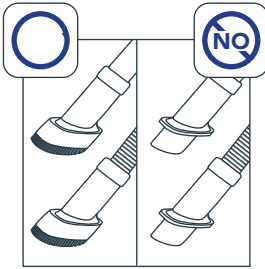
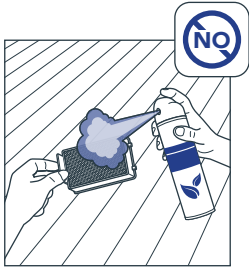
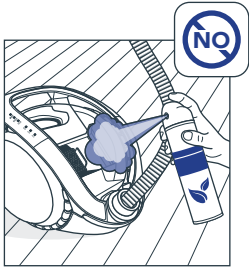
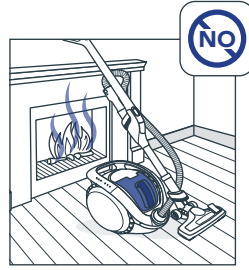
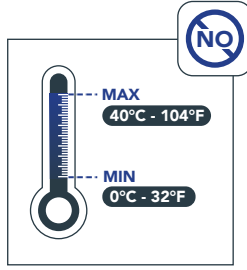



Thank you for choosing to buy a Rowenta X-Ö.

Your appliance is equipped with the last Rowenta technologies.

Read carefully this manual to get the most out of your appliance capacities.

Scan with your phone camera or QR reader to watch helpful video guide on how to assemble your appliance.



ASSEMBLY



Warning!
An action to be taken before the first use
see page 176.

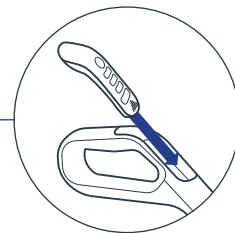
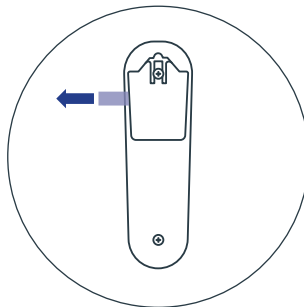

YOUR APPLIANCE WILL NEED TO BE FULLY CHARGED BEFORE FIRST USE

First connect the jack before plugging.

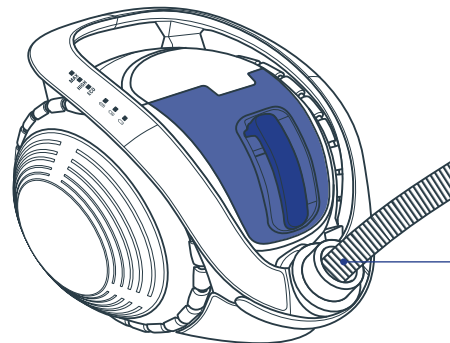
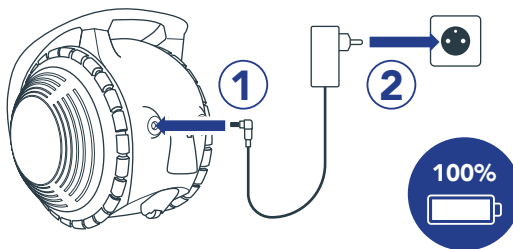

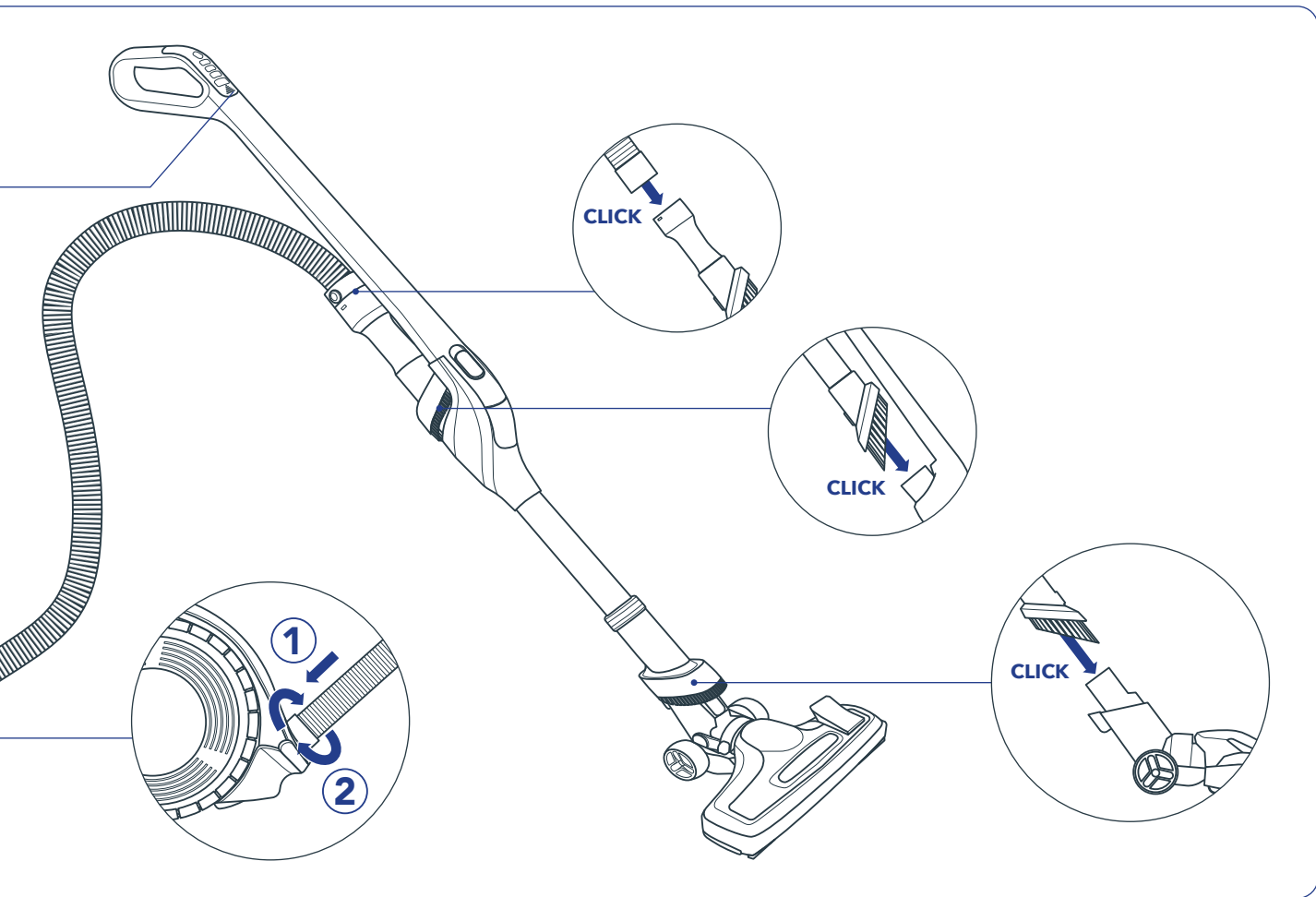

BEFORE THE FIRST USE



How to pair my remote control?



Pair your remote control before the first usage.

To be done only once.

	What you need to do:	What you can see on your appliance:
1	Take off the plastic tab before the first use.	
2	<u>Switch your appliance on:</u> Press on/off button.	Battery blue LEDs are lighting.
3.1	<u>Launch pairing:</u> Press simultaneously MAX and II buttons.	- You hear a confirmation beep - Battery blue LEDs and green speed indicators LEDs are blinking alternatively
3.2	<u>Confirm pairing:</u> Press immediately after step 3.1 on button II . (while LEDs are blinking alternatively)	- Blue LEDs keep lighting - You hear a double beep If you did not hear double beep after 10 seconds: pairing has failed. Switch your appliance off and start again from step 2.
<p>➤ Congratulations! You have successfully paired your remote control.</p>		

POWER BUTTON ON/OFF

To turn on and off your appliance, press shortly the Power button.

To start vacuuming, press on ECO, HIGH or MAX speed on your remote.

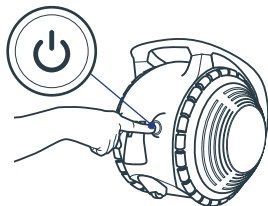

POWER MODE

Your appliance has 4 power modes for different tasks. Change cleaning modes using your remote control buttons and adjust the power:

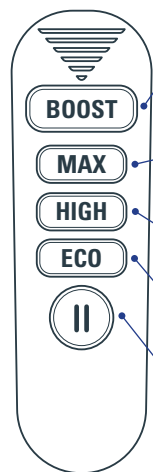

BOOST : 5/10min*

Intensive cleaning for ground-in-dirt.

NB: Keep pressing the BOOST button to use this mode.

MAX: 20/40min*

Intensive cleaning and encrusted dust. Ideal on all types of carpets.

HIGH: 40/50/90min*

For maintenance cleaning. Ideal for all types of hard floors.

ECO: 1h10/1h30/2h40min*

For lightly soiled floors and delicate surfaces: shelves, frames, curtains etc.

PAUSE:

Temporary shutdown during use.

The LEDs indicate the power modes.

In BOOST mode, all three green lights will flash on simultaneously.

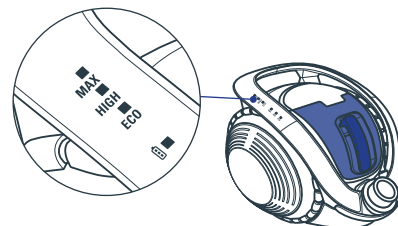

*depending on model.

SUCTION NOZZLE

Your 2-position nozzle is equipped with a pedal switch which allows you to alter between the carpet or hard floor position.

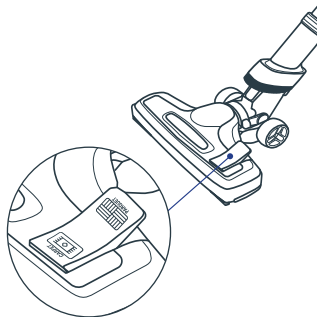

PARQUET

Hard floor position, compatible with wooden parquet, tiles, linoleum etc.



CARPET

Carpet position, perfect for in-depth vacuuming of any carpet or rug.

REMOTE CONTROL

Your appliance is managed by a remote control, integrated into the handle. It is powered by a round battery type CR2032.

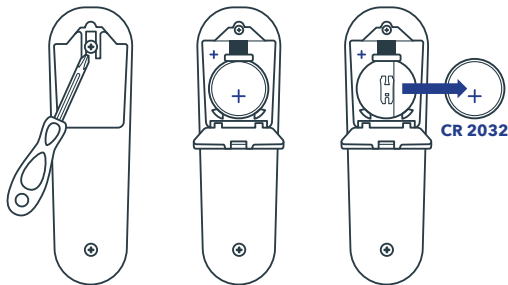

We advise you to change the battery every 18 months.

In case of loss or damage of your remote control, you can still power on your appliance by pressing the ON button longly

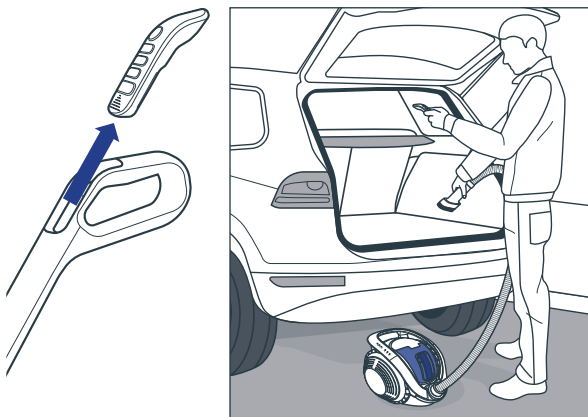

You can detach your remote control to perform all your cleaning sessions only with the flexible hose (ideal for cleaning your car, for example).

How to use my remote control?



BATTERY & CHARGE



THE FULL BATTERY CHARGE TAKES 4 HOURS.

To charge your appliance, you have a choice between two options:

OPTION 1

Connect the charger to the vacuum cleaner directly: first insert the jack, then plug.

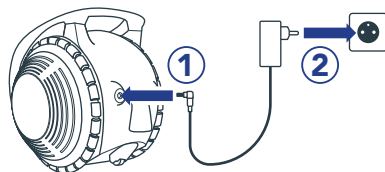

OPTION 2

Connect the charger to battery.

To do so, remove the battery from the appliance, insert the jack and then plug the charger.

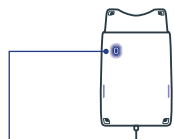
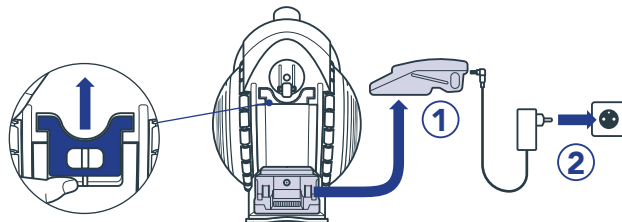

Blue light on:
the battery is charging.

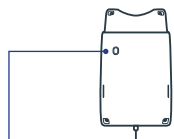

Blue light off:
the battery is charged.

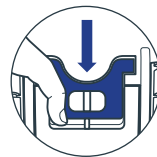
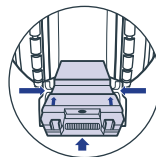

Scan to learn more about your battery and its charging.



BATTERY STATUS

Your appliance indicates your level of charge:

- 3 blue LEDs lighting: 100% charged.
- 2 blue LEDs lighting: 60% charged.
- 1 blue LED flashing: appliance needs to be recharged.

If the battery is fully discharged, 1 blue LED flashes few times.

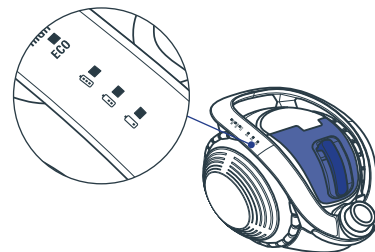

FLEX FUNCTION

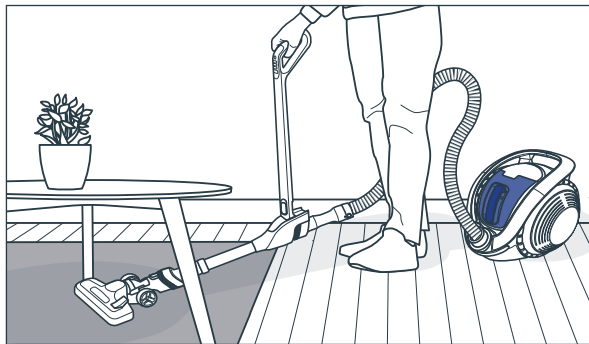

Your appliance is equipped with Flex technology. It allows you to reach the furthest areas under low height furniture effortlessly.

To activate it, slide the Flex button upwards.

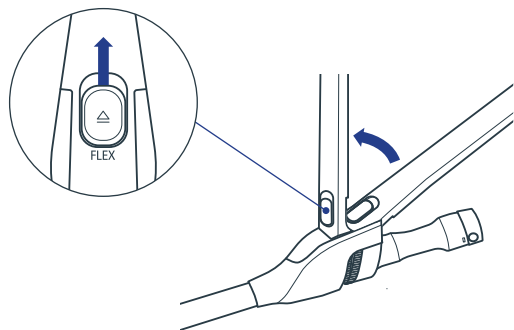

ACCESSORIES

Your appliance has 2 integrated Easy Dusting brushes. You can use them to vacuum the most of surfaces.

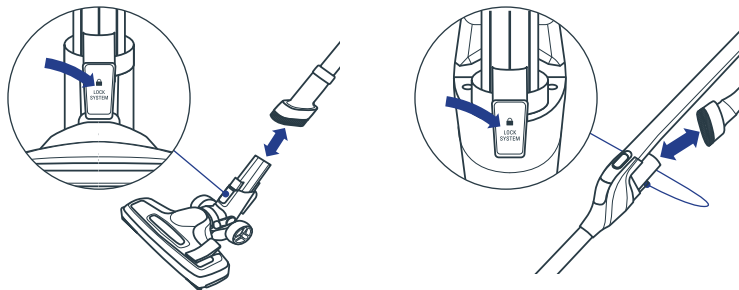

For specific areas cleaning, use additional accessories: insert them in one of the tubes at maximum depth.

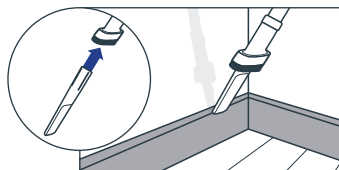

Use **the crevice tool** to vacuum hard to reach places.

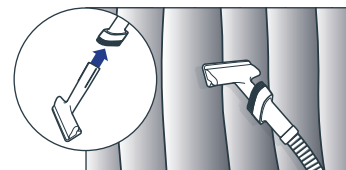

Use **the sofa brush** to vacuum textiles like sofa, curtains or mattress.

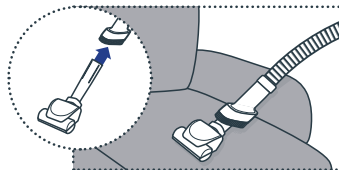

Use **the mini turbo brush on MAX or BOOST mode, to vacuum in-depth your sofas, mattress or car mats.



MAINTENANCE

Scan with your phone or QR reader to get the most out of maintenance advices for the best performance.



EMPTYING THE DUST CONTAINER

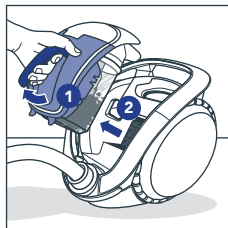
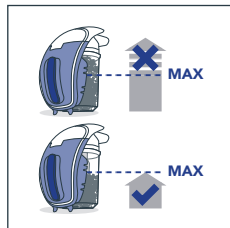

THE CYCLONE FILTER MAINTENANCE

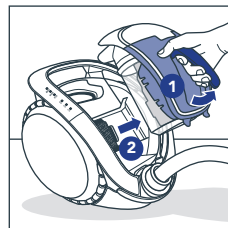
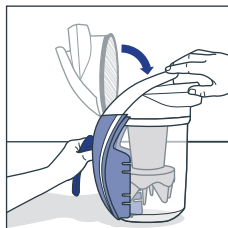
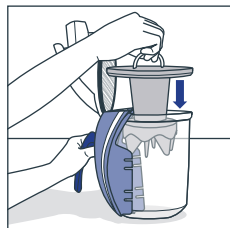
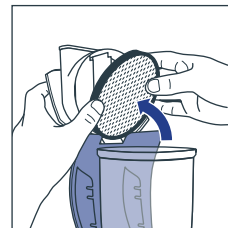
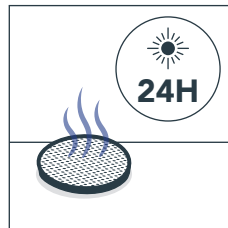
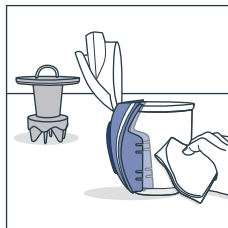
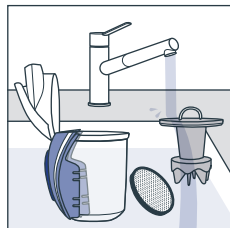

Wash your cyclone filter with water after each dust container emptying. Replace it once a year. To buy a new one, look for reference Rowenta ZR007700.

THE MOTOR FILTER MAINTENANCE



1X
MONTH

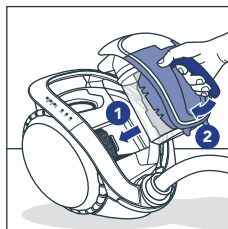
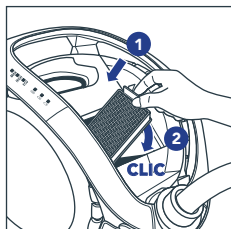
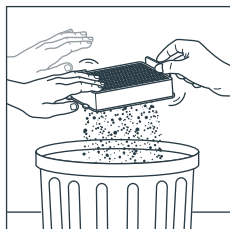
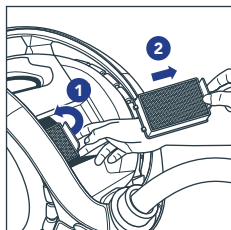
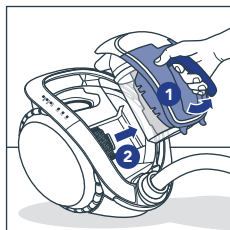

1X
YEAR

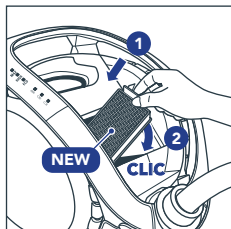
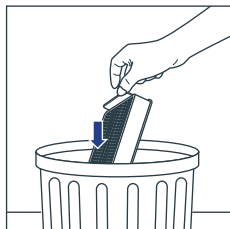

Replace your motor filter once a year.

To buy a new one, look for reference Rowenta ZR007700.

CLEANING THE MINI TURBO BRUSH

Always take off your Mini Turbo Brush accessory before cleaning (available on some models).

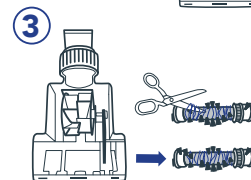
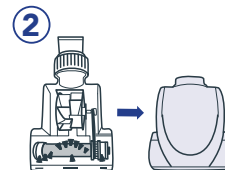

STORAGE

OPTION 1

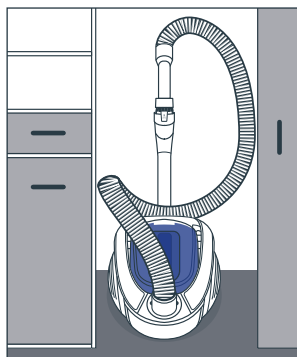
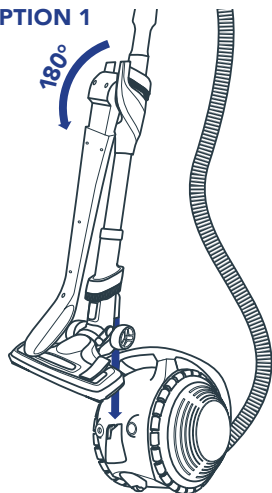

OPTION 2

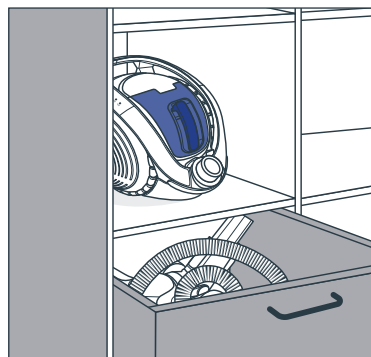
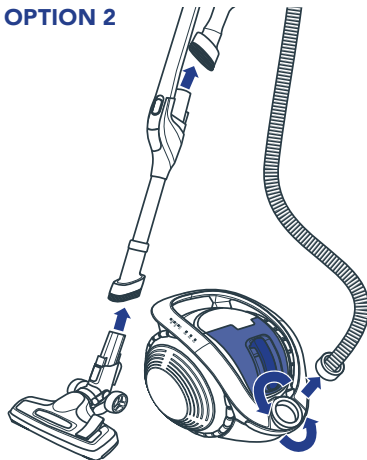

CAUTION

