

**ELEGOO**

# Saturn 4 Ultra 3D Printer

**User Manual**

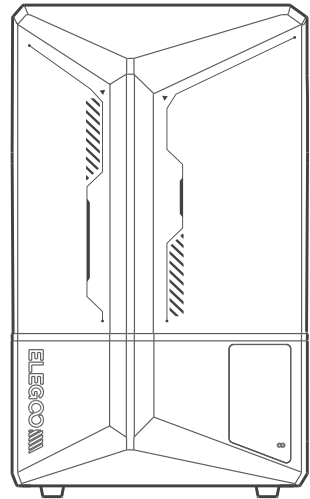

## Thank you for purchasing ELEGOO brand products.

---

After receiving the product, please confirm whether the equipment is intact and the accessories are complete. If there is any damage or missing, please timely contact us at [3dp@elegoo.com](mailto:3dp@elegoo.com). (To ensure the performance of each product, each product will undergo strict printing tests before leaving the factory. There may be some slight scratches when you receive the product, which is normal, please rest assured to use.)

**ELEGOO**

## Notice:

---

- Please keep the 3D printer and its accessories out of the reach of children.
- Please fill the resin tank no less than 1/3 of its volume, but do not exceed the MAX line position.
- Please place the printer in a dry environment and protect it from rain and moisture.
- If you run into an emergency during use, please turn off the power supply of the 3D printer first.
- Please use the printer indoors and avoid direct sunlight and a dusty environment.
- Please keep the original packaging box for 30 days for return/exchange (only ELEGOO original packaging boxes are accepted).
- If the printing fails, you need to clean the excess cured resin in the resin tank and change the resin, otherwise, it may cause damage to your printer.
- When operating the 3D printer, please wear a mask and gloves to avoid direct skin contact with the photopolymer resin.
- If the release film in the resin tank is whitened, scratched, or has no elasticity, the printing failure rate is high, please replace the release film in time.
- Please use 95% (or higher) ethyl alcohol or isopropyl alcohol to wash your model unless you are using water washable resin.
- If you have any problems with the printer, please contact us at [3dp@elegoo.com](mailto:3dp@elegoo.com). Please do not disassemble or modify ELEGOO 3D printers by yourself, otherwise, the warranty will expire, and damage caused by personal operating errors need to pay for repairs.

## Packing List

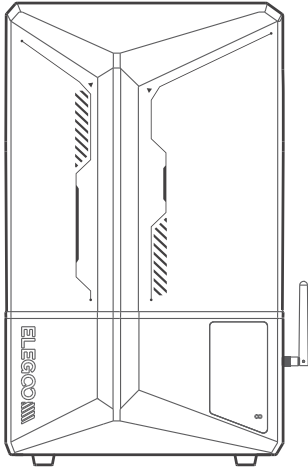

Saturn 4 Ultra 3D Printer



Wifi Antenna

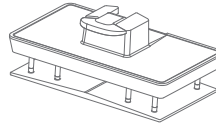

Build Platform

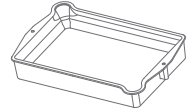

Resin Tank

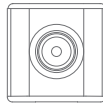

AI Camera



Resin Tray



USB Flash Disk



Mask

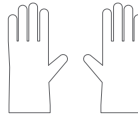

Gloves



Funnel



Backup Screws



User Manual



Adapter



Tool Kit

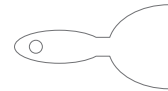

Scraper

## Printer Introduction

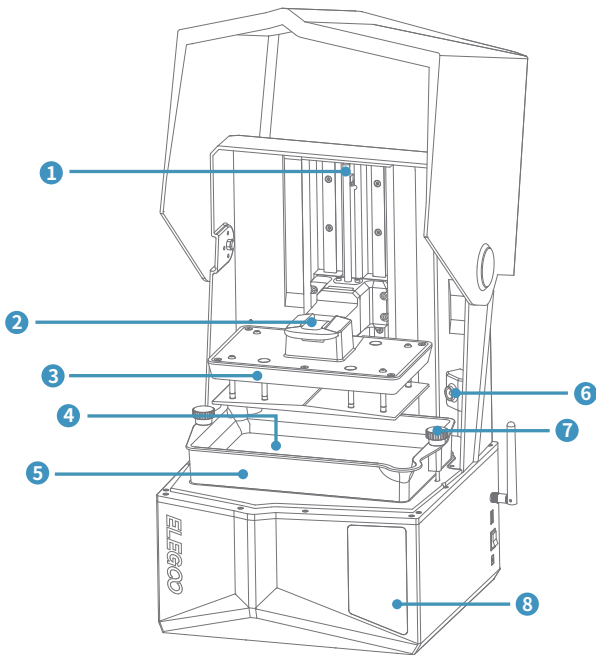

1 Z Axis

2 Handle

3 Build Plate

4 LCD Display Screen

5 Resin Tank

6 AI Camera

7 Screw Knob

8 Touch Screen

## Printer Introduction

---

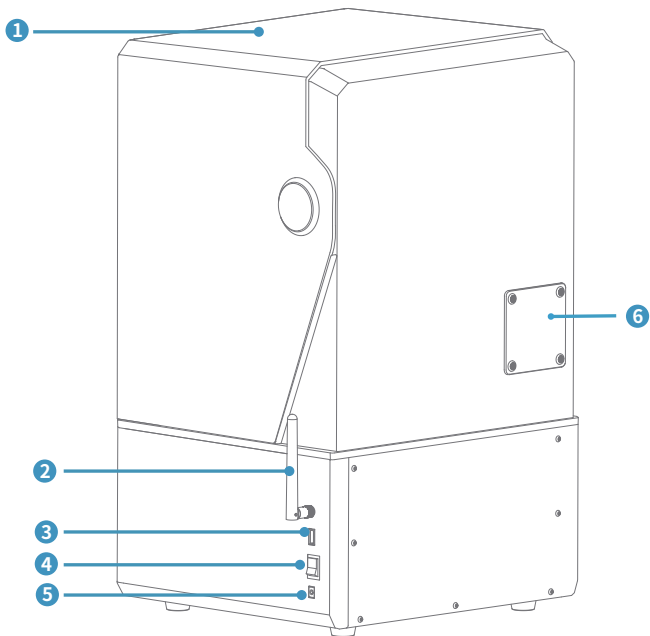

① Anti-UV Cover

② Wifi Antenna

③ USB Interface

④ Switch

⑤ DC Socket

⑥ Extension Port

## 3D Printer Tech Specs

---

**System:** EL3D-4.0  
**Operation:** 4.0-inch Capacitive Touch Screen  
**Slicer Software:** Chitu Box  
**Connectivity:** USB Interface & WiFi

### Printing Parameter

---

**Technology:** MSLA Stereolithography  
**Light Source:** COB Light Source + Fresnel Collimating Lens (wavelength 405nm)  
**XY Resolution:** 19\*24um (11520\*5120)  
**Z-axis Accuracy:** 0.02mm  
**Layer Thickness:** 0.01-0.2mm  
**Printing Speed:** 5.5S/Layer  
**Power Requirements:** 100-240V 50/60 Hz 24V 6A

### Printing Specification

---

**Dimension:** 327.4mm(L)\*329.2mm(W)\*548mm(H)  
**Build Volume:** 218.88mm(L)\*122.88mm(W)\*220mm(H)  
**Package Size:** 685mm(L)\*455mm(W)\*455mm(H)  
**Gross Weight:** 17.5KG  
**Net Weight:** 14.5KG

### Hardware Specification

## Test Printing

After inserting the build platform into the connecting block, press down the handle to secure the build platform to the connecting block (the build plate is capable of self-leveling and ready to use right out of the box).

Handle

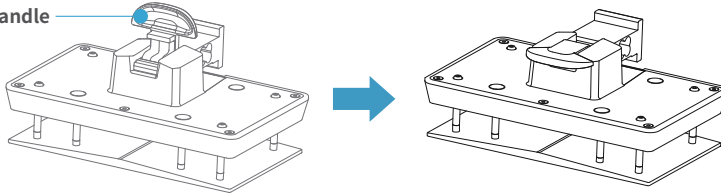

### 1. Model Printing

Slowly add the resin into the resin tank (the resin level is not less than 1/3 of the tank volume and does not exceed the MAX line. The machine will perform a self-check before printing, and do not touch the machine during the self-check). Cover the printer's anti-UV cover and then select the sliced test model for printing.

### 2. Model Processing

After printing is completed, wait until the resin on the build plate stops dripping, then lift the handle to take out the build plate, and use a scraper to remove the model. You can use ELEGOO's cleaning and curing machine to post-process the model.

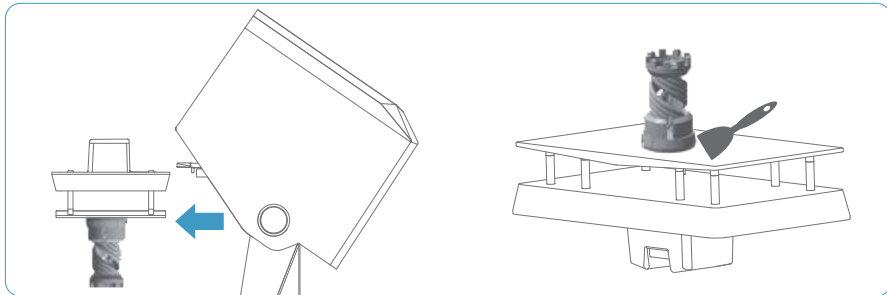

## Software Installation and Setup

The printer can install and use the Chitu Box in the USB flash drive.

### 1. Install Chitu Box

Select from the USB flash drive or go to Chitu's official website ([www.chitubox.com](http://www.chitubox.com)) to download the right slicing software version and install it on your computer.

### 2. How to Use Chitu Box

After the installation is complete, run the Chitu Box software. Click "File-Open File", then open your 3D model file (.stl type). By left-clicking on the model and using the options on the left menu, you can control and change the viewing angle, size, and position of the model.

### 3. Chitu Box Setting

#### 3.1 Machine Configuration Parameters

Click "Parameter Settings" and select ELEGOO Saturn 4 Ultra as your default printer. (See Picture 1)



(Picture 1)

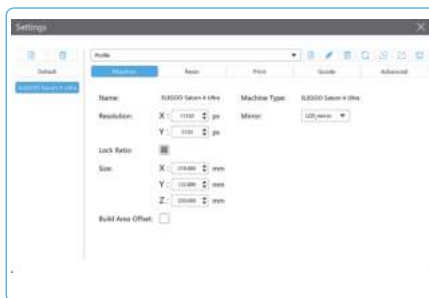

(Picture 2)

#### 3.2 Build Volume

You don't need to change the default parameters (See Picture 2), and X indicates the maximum print size in the X-axis direction, and so on.

#### 3.3 Resin Parameter (See Picture 3)

**Resin Density:** 1.1g/ml

**Resin Cost:** You can input the real price of the resin you purchased, and the slicing software can calculate the resin costs for each model you print.

## Software Installation and Setup

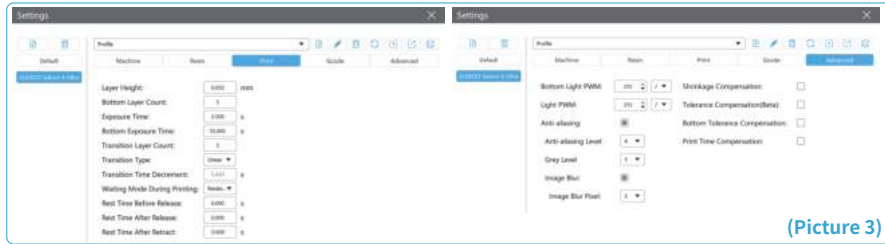

(Picture 3)

### 3.4 Parameters (See Picture 3)

**Layer Height:** The thickness of each printed layer, the recommended height is 0.05mm, but you can set it from 0.01-0.2mm. The higher the thickness you set, the longer the exposure time will be required for each layer.

**Bottom Layer Count:** The setting number of initial printing layers. If the number of bottom layers is n, the exposure time of the first n layers is the exposure time of the bottom layer. The default setting is 5 layers.

**Exposure Time:** The exposure time for normal printing layers. The default exposure time is 2.5 seconds, and the thicker the printing layer setting is, the longer the time it will take.

**Bottom Exposure Time:** The setting of bottom layer exposure time. Properly increasing the bottom exposure time can help to increase the stickiness between the printed model and the printing platform, and the default setting is 35 seconds.

**Transition Layer Count:** The number of transition layers after the bottom layers for a tighter bonding between layers. Except for the exposure time, other parameters of the transition layers are the same as the normal layers.

**Transition Type:** Set the transition type of exposure time when transitioning from bottom layers to normal layers, the default is linear transition.

**Rest Time Before Release:** The time difference between the end of print exposure and the start of printer release. The default is 0 seconds.

**Rest Time After Release:** After the printing platform is lifted, the time difference between the printer starts to rest and starts to return. The default is 0 seconds.

**Rest Time After Retract:** The time difference between the printer starts to rest after retraction and the start of exposure. The default is 0 seconds.

**Note:** The printing parameters listed in this manual are for reference only. In actual applications, please contact the official after-sales technical support to confirm the parameters based on comprehensive factors such as the machine model and resin (including type and color) used by the individual.

## Network Management Center

1. After the printer is connected to WiFi, open the slicing software and click  in the upper right corner to enter "Network Management Center" (You need to download and install Chitu Manager for first time use.) (See Picture 4)

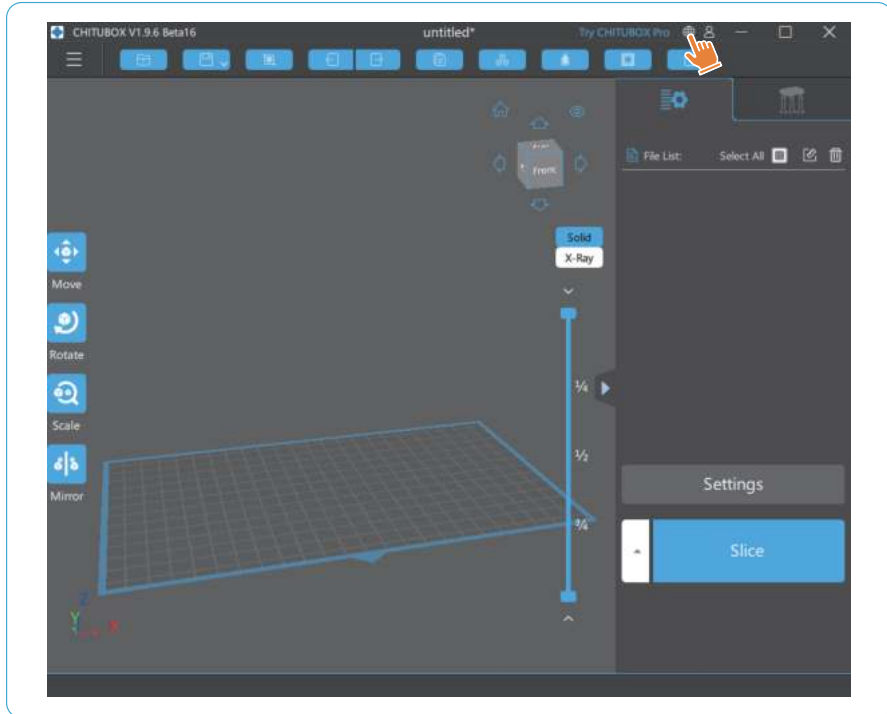

(Picture 4)

## Network Management Center

2. After entering the network management center, click "Add Device" to associate the printer (make sure the computer and printer are in the same LAN), and the associated device can be remotely controlled through the computer. (See [Picture 5](#))

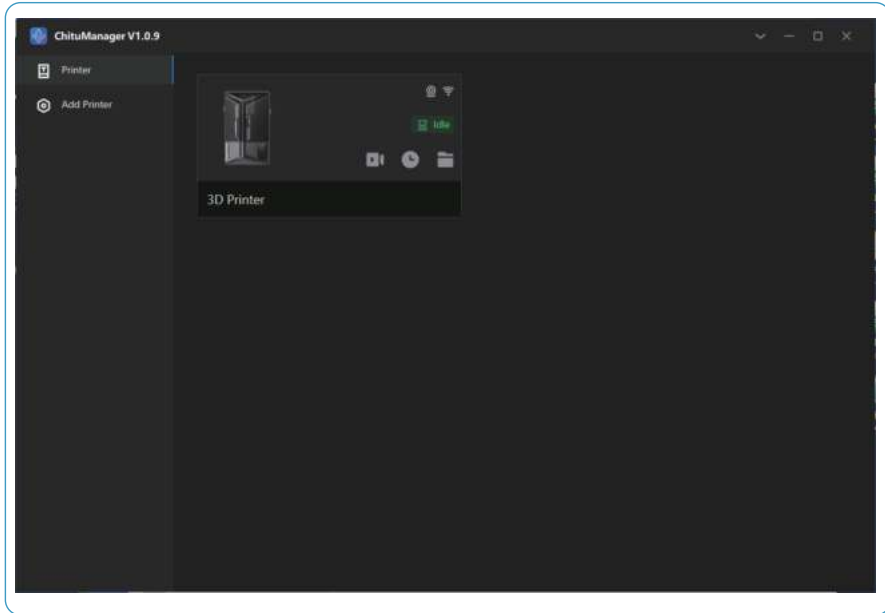

(Picture 5)

## Network Management Center

3. In the printer management interface, you can turn on the camera to observe the printing situation in real time, and you can also control the time-lapse photography function to turn on or off. (See Picture 6)

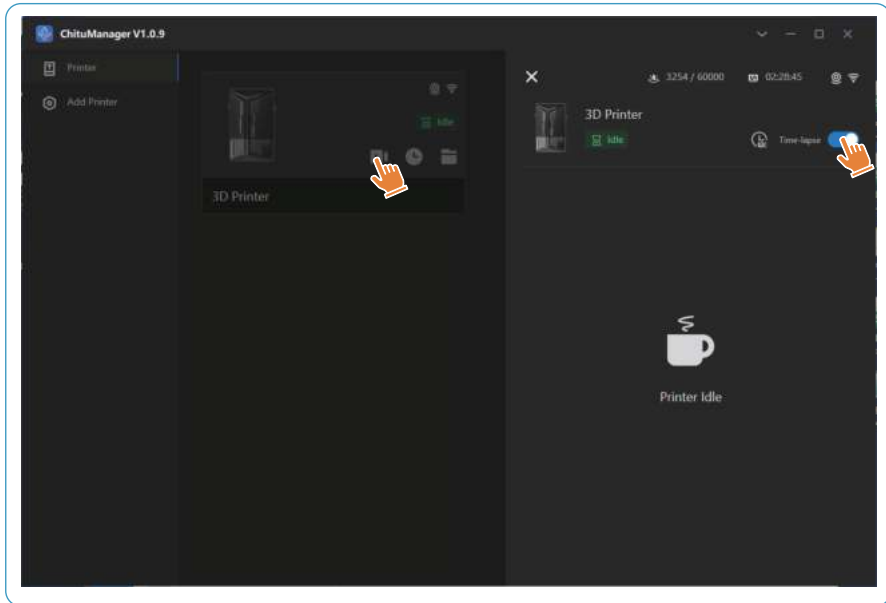

(Picture 6)

## Machine Maintenance

---

- Please do not use sharp or pointy tools to scrape the resin tank to avoid damaging the release liner film.
- Please clean up the resin tank before changing the resin to another color.
- Before and after printing, clean the build plate with paper towels or alcohol to ensure that there are no bumps or burrs on the build plate.
- Before each printing, daily check the exterior of the machine and all mechanical parts for any obvious damage, defects, or abnormalities.
- Try to keep the printing environment at 25-30 degrees Celsius when printing, and ventilate the printing room as much as possible to facilitate heat dissipation of the machine and resin odor volatilization.
- If the Z-axis keeps making friction noise, please add some lubricant to the lead screw. Please check and apply lubricant grease at least every 2-3 months, and increase the frequency of application as the printing frequency increases.
- If you don't use the printer in the next 48 hours, please pour the remaining resin from the resin tank back into the resin bottle and seal it well. If there is any residue, please use a filter to filter it out.
- The release film is a wearing part, please replace it regularly according to the machine prompts to ensure the success rate of printing.
- Please be careful when removing the printing platform to prevent damaging the LCD screen. The service life of the screen is about 2000+ hours and will decrease with increasing printing frequency. Do a good job of daily screen cleaning, and unplug the machine in time after printing. If there is a screen exposure problem or service life has seriously affected the print quality, please replace the screen in time.

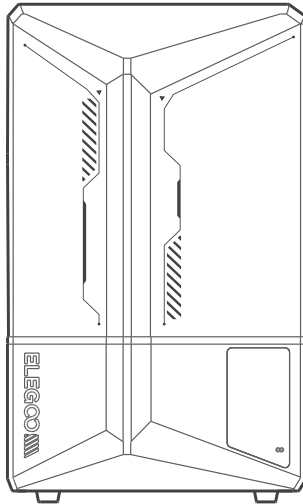

Email Support



Discussion Forums



Help Articles

## FCC Warning

This device complies with part 15 of the FCC Rules. Operation is subject to the following two conditions: (1) This device may not cause harmful interference, and (2) this device must accept any interference received, including interference that may cause undesired operation.

Any Changes or modifications not expressly approved by the party responsible for compliance could void the user's authority to operate the equipment.

**Note:** This equipment has been tested and found to comply with the limits for a Class B digital device, pursuant to part 15 of the FCC Rules. These limits are designed to provide reasonable protection against harmful interference in a residential installation. This equipment generates uses and can radiate radio frequency energy and, if not installed and used in accordance with the instructions, may cause harmful interference to radio communications. However, there is no guarantee that interference will not occur in a particular installation. If this equipment does cause harmful interference to radio or television reception, which can be determined by turning the equipment off and on, the user is encouraged to try to correct the interference by one or more of the following measures:

- Reorient or relocate the receiving antenna.
- Increase the separation between the equipment and receiver.
- Connect the equipment into an outlet on a circuit different from that to which the receiver is connected.
- Consult the dealer or an experienced radio/TV technician for help.

This equipment complies with FCC radiation exposure limits set forth for an uncontrolled environment. This equipment should be installed and operated with minimum distance 20cm between the radiator & your body.