

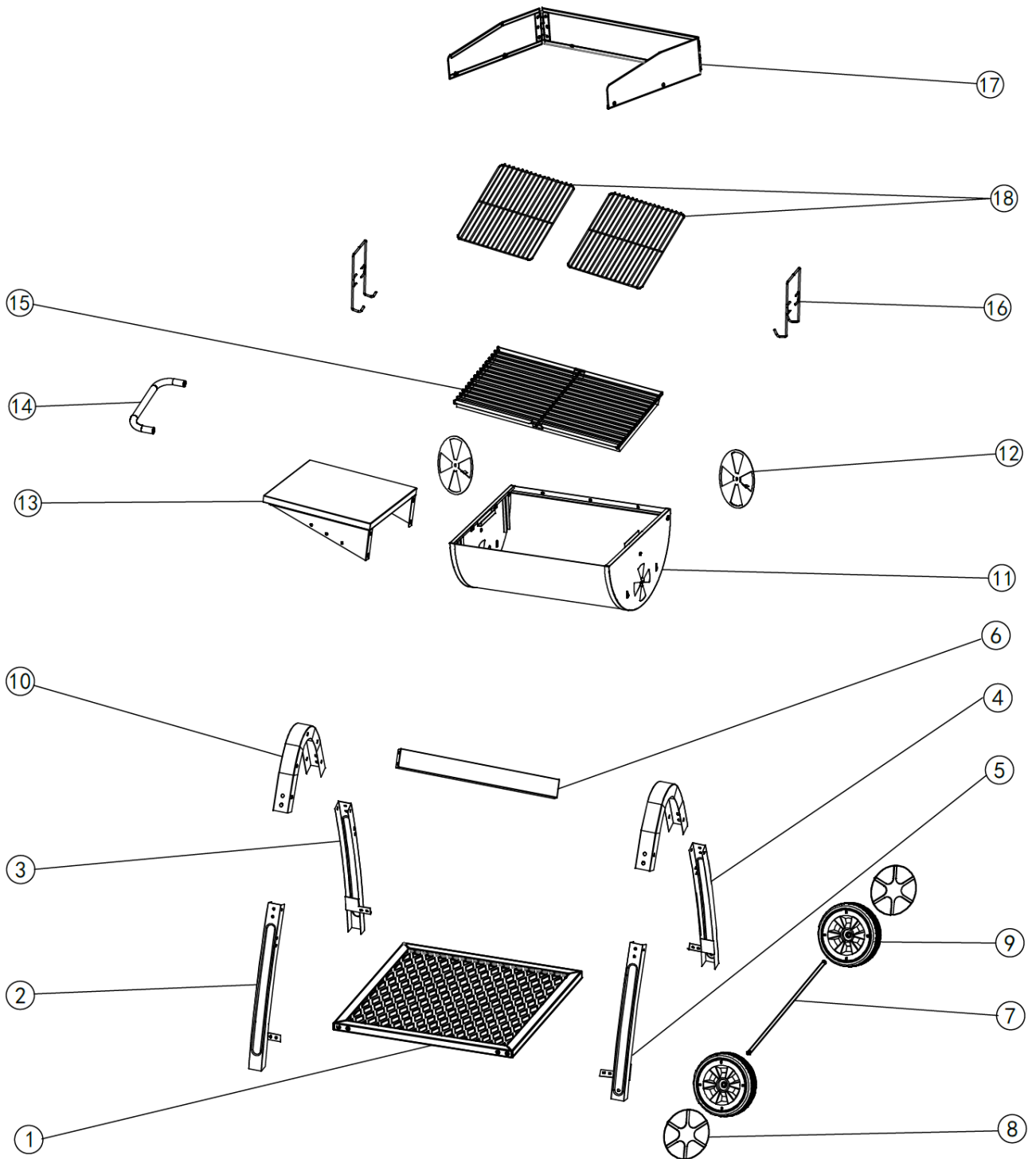

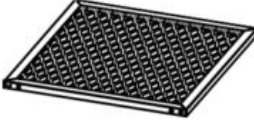















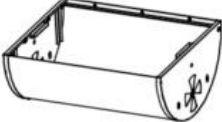



 HP2	 50min
--	--	--



① *1 	② *1 (LF) 	③ *1 (LB) 	④ *1 (RB) 	⑤ *1 (RF) 
⑥ *1 	⑦ *1 	⑧ *2 	⑨ *2 	⑩ *2 
⑪ *1 	⑫ *2 	⑬ *1 	⑭ *1 	⑮ *1 
⑯ *2 	⑰ *1 	⑱ *2 		
A M6-12*42 		B M4-8*6 		C *2 
D M4*2 		E $\phi 1.5-28*2$ 		F M6*2 

1

A

2

A

A			8PCS
A			16PCS

3

A

4

A

C		2PCS	
E		2PCS	
A			6PCS

5

A			4PCS
----------	--	--	------

6

A			2PCS
F			2PCS

7

B			6PCS
D			2PCS

8

A			2PCS
----------	--	--	------

