

Ref. 477403 - 477404

FR - Lecteur CD avec radio FM et port USB Soft Grey & Pop Purple

EN - CD player with FM radio and USB port Soft Grey & Pop Purple

IT - Lettore CD con radio FM e porta USB Soft Grey & Pop Purple

ES - Radio CD FM y puerto USB Soft Grey & Pop Purple







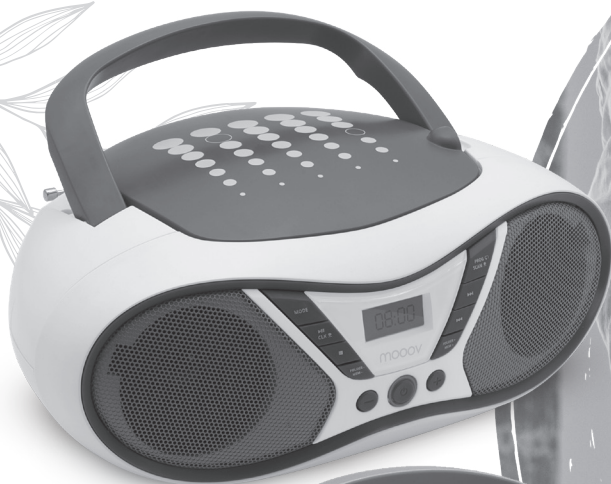

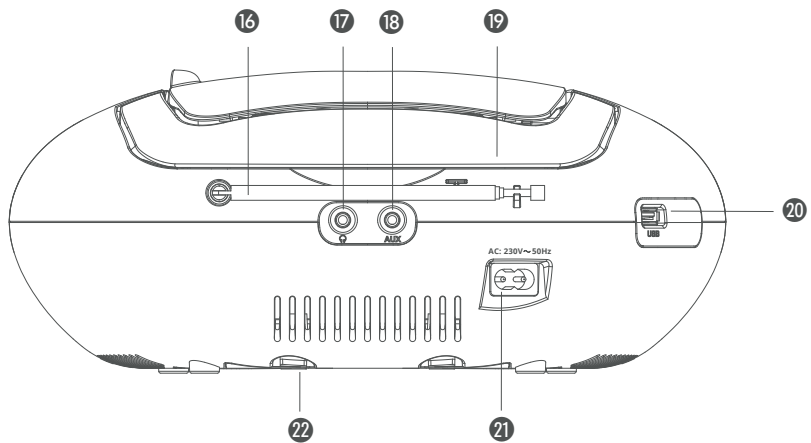
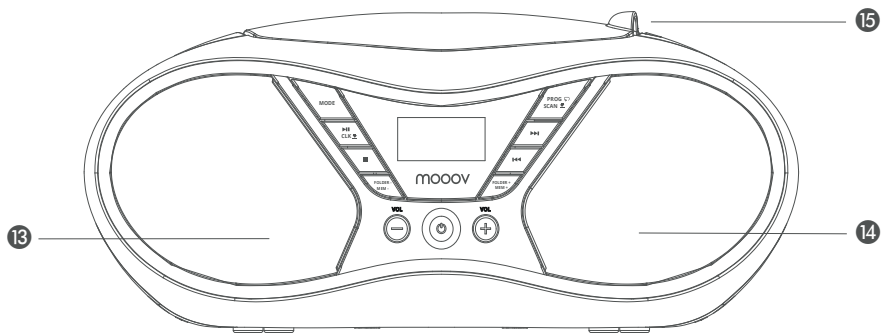
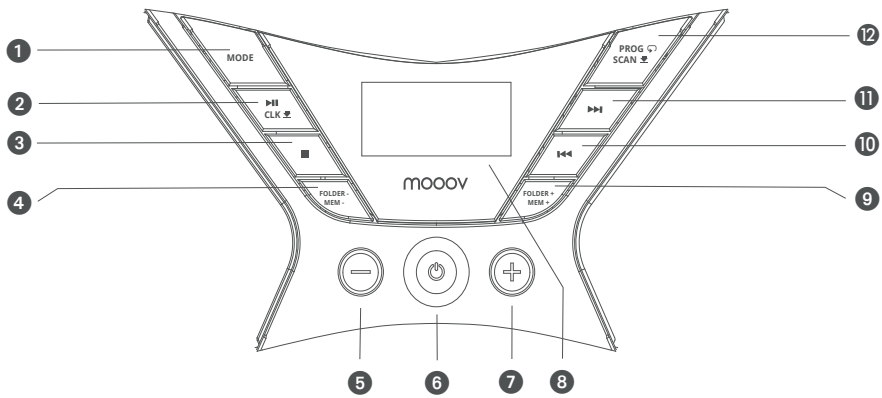
PT - Rádio CD FM e porta USB Soft Grey & Pop Purple

DE - CD-Player mit UKW-Radio und USB-Anschluss Soft Grey & Pop Purple

NL - Gebruikershandleiding CD-speler Soft Grey & Pop Purple





1	MODE	Sélecteur cd / USB / AU / rAd
2		Lecture ou pause / CLK  : Réglage de l'heure (avec appui long)
3		Stop
4		FOLDER - : Dossier précédent / MEM - : Radio mémorisée précédente
5	VOL -	Volume -
6		Marche - Arrêt
7	VOL +	Volume +
8		Écran LCD : Affiche les informations de lecture en cours (mode, numéro de titre, etc...)
9		FOLDER + : Dossier suivant / MEM + : Radio mémorisée suivante
10		Titre précédent ou fréquence FM précédente pas à pas / Retour rapide (avec un appui long)
11		Titre suivant ou fréquence FM suivante pas à pas / Avance rapide (avec un appui long)
12	PROG	Création d'une playlist /  : Fonction répéter par morceau, par dossier, l'ensemble et fonction Random (lecture aléatoire) / SCAN  (avec un appui long) : Lance la recherche automatique des radios
13		Haut-parleur gauche
14		Haut-parleur droit
15		Trappe du disque
16		Antenne FM
17		Sortie casque 3.5mm impédance 32Ω. Avant de brancher un casque, mettez le volume au minimum puis ajustez ensuite le volume selon votre désir.
18	AUX	Prise auxiliaire
19		Anse
20	USB	Port USB
21		Connecteur d'alimentation secteur
22		Compartiment à piles/ 6x 1,2-1,5V type C / LR14 (non fournies)

BRANCHEMENTS

Branchez l'appareil sur le secteur.

Fonctionnement sur piles : ouvrez le compartiment à piles, insérez 6 piles de type C / LR14 en respectant le schéma de polarité indiqué.

COMMENT ÉCOUTER LA RADIO

- Si l'appareil est éteint, appuyez sur le bouton  et l'appareil s'allume.
- Appuyez sur **MODE** pour sélectionner le mode **rAd**.
- Réglez le volume.
- Déployez l'antenne **FM**.

Pour rechercher manuellement une station et la mémoriser :

- Appuyer pas à pas sur les touches **◀◀** ou **▶▶**.
- Lorsqu'une station est trouvée, appuyez sur **PROG** pour afficher le numéro d'un emplacement libre, exemple = **P01**.
- Appuyez aussitôt pas à pas sur les touches **MEM -** et **MEM +** pour choisir l'emplacement souhaité entre **P01** et **P20**.
- Appuyez aussitôt à nouveau sur **PROG** pour quitter la programmation.
- Renouvelez ces réglages pour mémoriser les autres stations.
- Les touches **MEM -** et **MEM +** vous permettent ensuite d'accéder aux stations mémorisées.



Pour rechercher automatiquement une station et la mémoriser :

- Faites un appui long sur les touches **◀◀** ou **▶▶**. La recherche automatique démarre et s'arrête sur la première radio reçue correctement.
- Lorsque la station recherchée est trouvée, appuyez sur **PROG** pour afficher le numéro d'un emplacement libre, exemple = **P01**.
- Appuyez aussitôt pas à pas sur les touches **MEM -** ou **MEM +** pour choisir l'emplacement souhaité entre **P01** et **P20**.
- Appuyez aussitôt à nouveau sur **PROG** pour quitter la programmation.
- Renouvelez ces réglages pour mémoriser les autres stations.
- Les touches **MEM -** et **MEM +** vous permettent ensuite d'accéder aux stations mémorisées.

Pour rechercher automatiquement toutes les stations :

- Appuyez sur la touche **SCAN** pendant 2 secondes pour lancer la recherche automatique.
- Lorsque le tuner trouve une station, il la mémorise automatiquement (jusqu'à 20 stations).
- Les touches **MEM -** et **MEM +** vous permettent ensuite d'accéder aux stations mémorisées.

COMMENT ÉCOUTER LES CDs

- Si l'appareil est éteint, appuyez sur  et l'appareil s'allume.
- Appuyez sur **MODE** pour sélectionner le mode **cd**.
- Ouvrez le couvercle (15 page 2).
- Mettez un CD (écriture sur le dessus) dans le lecteur. Refermez le couvercle. Le nombre total de titres apparaît sur l'afficheur après quelques secondes.
- La lecture se lance automatiquement à partir de la piste 1.
- Appuyez sur la touche **◀◀** ou **▶▶** pour sélectionner la piste désirée.
- Pour avancer ou reculer rapidement, appuyez longuement sur **◀◀** ou **▶▶**.
- La touche **▶▶** permet de mettre en pause puis de relancer la lecture.
- Appuyez sur  pour arrêter la lecture.

COMMENT ÉCOUTER DE LA MUSIQUE A PARTIR DU PORT USB

Insérez la clé dans le port **USB**.

Si l'appareil est éteint, appuyez sur  et l'appareil s'allume.

- Appuyez sur **MODE** pour sélectionner **USB**.
- L'afficheur clignote puis le nombre total de titres apparaît après quelques secondes.
- La lecture se lance automatiquement à partir du titre 1.

- Appuyez sur la touche **◀◀** ou **▶▶** pour sélectionner la piste désirée.
- Pour avancer ou reculer rapidement, appuyez longuement sur **◀◀** ou **▶▶**.
- Appuyez sur les touches **VOL +** et **VOL -** pour ajuster le volume
- Pour arrêter la lecture, appuyez sur **■** et retirez la clé **USB**.
- NOTE : les clés **USB** doivent être formatées en FAT.

FONCTIONS SPÉCIALES

Mode REPEAT

Pour re-boucler sur la piste en cours :

- Pendant la lecture, appuyez 1 fois sur la touche **↻**.
- Le symbole **REP** clignotant apparaît sur l'afficheur.

Pour re-boucler sur un dossier du disque :

- Pendant la lecture, appuyez 2 fois de suite sur la touche **↻**.
- Le symbole **REP FOLDER** apparaît fixe sur l'écran.

Pour re-boucler sur l'ensemble du disque :

- Pendant la lecture, appuyez 3 fois de suite sur la touche **↻**.
- Le symbole **REP** apparaît fixe sur l'écran.

MODE RANDOM (lecture aléatoire)

- Pendant la lecture, appuyez 4 fois de suite sur la touche **↻**.
- L'inscription **RAND** s'affiche à l'écran.

MODE PROGRAM

Permet de créer une playlist afin de jouer successivement une sélection de titres en mode **Cd** ou **USB**. La liste peut contenir jusqu'à 20 titres avec un CD standard et peut contenir jusqu'à 99 titres avec un CD MP3, une clé USB MP3.

Pour démarrer une programmation exemple en mode **cd** :

- Appuyez sur la touche **MODE** pour sélectionner le mode **cd**.
- Appuyez sur **■** pour arrêter la lecture et afficher le nombre total de pistes.
- Appuyez sur la touche **PROG** et l'afficheur indique **P01** qui est le premier canal de la liste de lecture.
- Appuyez sans attendre sur la touche **◀◀** ou **▶▶** pour sélectionner la piste désirée.
- Appuyez aussitôt sur la touche **PROG** et l'afficheur indique **P02** qui est le second canal de la liste de lecture.
- Appuyez sans attendre sur la touche **◀◀** ou **▶▶** pour sélectionner la piste désirée.
- Appuyez aussitôt sur la touche **PROG** pour passer au canal suivant.
- L'afficheur passe au canal **P03** : Vous pouvez ainsi mémoriser les pistes dans l'ordre que vous avez choisi.
- La sélection terminée, appuyez sur le bouton **▶▶** pour lancer la lecture ou la mettre en pause.
- Appuyer une fois sur **■** pour arrêter la lecture
- Appuyez deux fois sur **■** pour quitter la programmation.

CONNECTEUR AUXILIAIRE

L'appareil peut être utilisé pour brancher un autre appareil audio (lecteur MP3, téléphone, etc.).

- Utilisez un câble jack 3,5mm (non fourni) pour connecter l'appareil audio à la prise **AUX** du lecteur Radio-CD.
- Appuyez une ou plusieurs fois sur **MODE** pour afficher **AU** et lire la musique provenant du périphérique audio externe (lecteur MP3, téléphone, etc.).
- Lancer et gérer la lecture des pistes sur le périphérique externe.
- Ajuster le volume sur le lecteur MP3.
- Appuyez sur les touches **VOL +** et **VOL -** pour ajuster le volume du lecteur CD-USB.

SORTIE POUR CASQUE



Au volume maximal, l'écoute peut endommager les oreilles sensibles.

- Prenez les précautions suivantes avant de mettre le casque sur les oreilles :
- Tenez le casque dans vos mains, sans le poser sur votre tête.
- Réglez le volume sonore du Radio-CD au tiers environ.
- Branchez le casque sur la sortie .
- Mettez en lecture le Radio-CD et vérifiez que le son sort du casque.
- Posez le casque sur les oreilles.
- Ajustez le volume à votre goût.

FONCTIONNEMENT SUR PILES

L'autonomie moyenne en utilisant des piles alcalines est d'environ 12h.
C'est pourquoi nous vous conseillons l'utilisation de batteries rechargeables.

CARACTÉRISTIQUES TECHNIQUES

Port USB :

- Accepte tous les périphériques se comportant comme des clés USB

Son :

- 2 x 3W
- System audio : stéréo
- Réglage du volume
- Prise casque 3.5mm (32 Ω)

Tuner :

- Radio FM
- Fréquences : 87,5-108MHz
- Réglage manuel et recherche automatique.

CD :

- Lecture des CD, CD-R, CD-RW

CD et port USB :

- Lecture des fichiers MP3
- Pistes programmables
- Fonction répétition et lecture aléatoire

Entrée AUX :

- L'entrée auxiliaire jack 3.5mm (AUX) permet de connecter la sortie audio d'un appareil (Exemple : sortie casque d'un lecteur MP3 – téléphone...)

Alimentation :

- Sur secteur 230V \sim 50Hz ou piles 1,2-1.5 V x6 type - C/LR14 (non fournies)

Consommation :

- 12 W max en marche
- 1 W en mode arrêt

Accessoires fournis :

- Câble secteur
- Notice d'utilisation

Marquages normatifs, dont C E , sous l'appareil.



ATTENTION : Cet appareil est un produit laser de Classe 1. Pour garantir une sécurité constante, ne retirez aucun des couvercles et n'essayez pas d'avoir accès à l'intérieur de l'appareil. Confiez toute réparation à un personnel qualifié.



Afin d'éviter des dommages auditifs éventuels, ne pas écouter à un niveau sonore élevé pendant une longue durée.



www.metronic.com/a/garantie.php



Ce logo signifie qu'il ne faut pas jeter les appareils hors d'usage avec les ordures ménagères. Les substances dangereuses qu'ils sont susceptibles de contenir peuvent nuire à la santé et à l'environnement. Faites reprendre ces appareils par votre distributeur ou utilisez les moyens de collecte sélective mis à votre disposition par votre commune.



Courant alternatif



Isolation double ou renforcée



Utilisation uniquement en intérieur



Le soussigné, METRONIC, déclare que l'équipement radio électrique du type radio CD 477403 est conforme à la directive 2014/53/UE. Le texte complet de la déclaration UE de conformité est disponible à l'adresse internet suivante:
<https://medias.metronic.com/doc/477403-ncg3cf-doc.pdf>

Dans un environnement soumis à des décharges électrostatiques, l'équipement peut temporairement présenter des dysfonctionnements voire s'éteindre. Cette situation nécessite l'intervention de l'utilisateur, typiquement une réinitialisation de l'équipement opérée par une déconnexion puis une reconnexion à la source d'alimentation. Il suffit ensuite d'allumer l'équipement et de le remettre dans le mode de fonctionnement souhaité. Lorsque le cordon secteur est utilisé comme dispositif de connexion, celui-ci doit demeurer aisément accessible.



Points de collecte sur www.quefairedemesdechets.fr



NOTICE



ASSISTANCE TECHNIQUE

MOOOV, une marque du groupe METRONIC : 02 47 346 392 / hotline@metronic.com

Munissez-vous des informations suivantes avant tout appel :







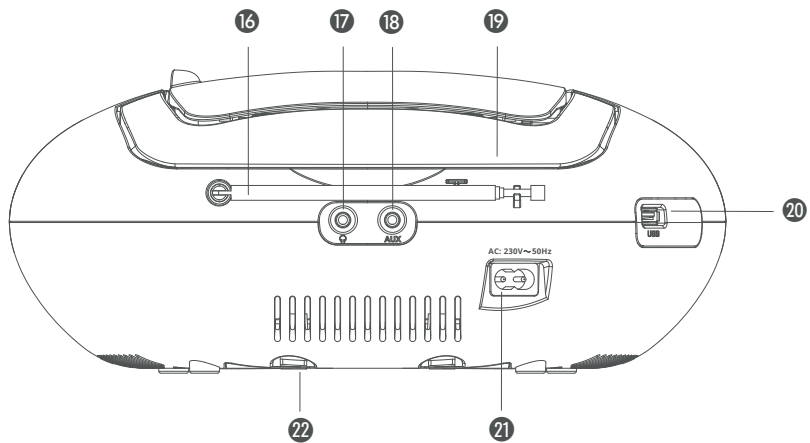
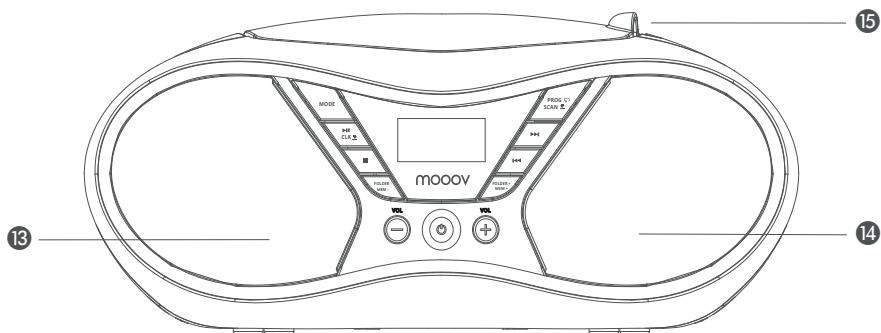
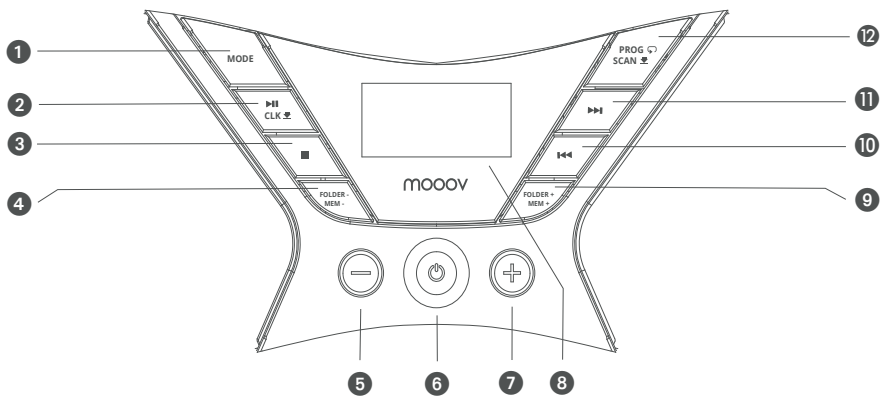

Lecteur CD Soft Grey (477403)

Lecteur CD Pop Purple (477404)

moov

100, rue Gilles de Gennes 37310 TAUXIGNY FRANCE - Fabriqué hors UE



1	MODE	CD / USB / AU / RAD selector
2		Play or pause / CLK  : Setting the time (with a long press)
3		Stop
4		FOLDER - : Previous folder / MEM - : Previous stored radio station
5	VOL -	Volume -
6		Play - Stop
7	VOL +	Volume +
8		LCD screen: Current playback information display (mode, track number, etc.)
9		FOLDER + : Next folder / MEM + : Next stored radio station
10		Previous track or previous FM frequency step by step / rewind (press and hold)
11		Next track or next FM frequency step by step / fast forward (press and hold)
12	PROG	Create a playlist /  : Repeat track, repeat folder, repeat all functions and random function (random playback) / SCAN  (with a long press): Starts the automatic radio search
13		Left speaker
14		Right speaker
15		CD compartment cover
16		FM antenna
17		3.5 mm headphone jack, impedance 32 Ω. Set the volume to minimum before plugging in headphones and then adjust to your desired volume.
18	AUX	Auxiliary jack
19		Handle
20	USB	USB port
21		Power supply connector
22		Battery compartment/ 6 x 1.2-1.5 V type C / LR14 (not provided)

CONNECTIONS

Connect the device to the mains.

Battery operation: open the battery compartment, insert 6 type C / LR14 batteries in accordance with the indicated polarity.



HOW TO LISTEN TO THE RADIO

- If the device is switched off, press  and the device turns on.
- Press **MODE** to select **rAd** mode.
- Adjust the volume.
- Extend the **FM** antenna.

To manually search for a radio station and store it:

- Press the  or  buttons step by step.
- Once a station is found, press **PROG** to display the number of a free position, e.g. **P01**.
- Immediately press the **MEM -** and **MEM +** buttons step by step to choose the desired position between **P01** and **P20**.
- Immediately press **PROG** again to exit programming mode.
- Repeat these steps to store other radio stations.
- The **MEM -** and **MEM +** buttons then allow you to access stored stations.







To automatically search for a radio station and store it:

- Press and hold the  or  buttons. Automatic search starts and stops on the first radio station to be received correctly.
- Once the station you are searching for is found, press **PROG** to display the number of a free position, e.g. **P01**.
- Immediately press the **MEM -** or **MEM +** buttons step by step to choose the desired position between **P01** and **P20**.
- Immediately press **PROG** again to exit programming mode.
- Repeat these steps to store other radio stations.
- The **MEM -** and **MEM +** buttons then allow you to access stored stations.

To automatically search for all radio stations:

- Press and hold the **SCAN** button for 2 seconds to start the automatic search.
- When the tuner finds a radio station, it automatically stores it (up to 20 stations).
- The **MEM -** and **MEM +** buttons then allow you to access stored stations.



HOW TO LISTEN TO CDS

- If the device is switched off, press  and the device turns on.
- Press **MODE** to select **CD** mode.
- Open the cover (15, page 2).
- Insert a CD into the CD player (printed side up). Close the cover again. The total number of tracks appears on the display after a few seconds.
- Playback starts automatically from track 1.
- Press the  or  buttons to select the desired track.
- Press and hold  or  to fast forward or rewind..
- The  button allows you to pause and resume playback.
- Press  to stop playback.

HOW TO LISTEN TO MUSIC THROUGH THE USB PORT

Insert the **USB** stick into the **USB** port.

If the device is switched off, press  and the device turns on.

- Press **MODE** to select **USB** mode.
- The display flashes and then the total number of tracks appears after a few seconds.
- Playback starts automatically from track 1.
- Press the  or  buttons to select the desired track.

- Press and hold **⏮** or **⏭** to fast forward or rewind.
- Press the **VOL +** or **VOL -** buttons to adjust the volume.
- To stop playback, press **■** and remove the **USB** stick.
- Note: **USB** sticks must be in FAT format.

SPECIAL FUNCTIONS

REPEAT mode

To repeat the track which is currently playing:

- Press **↺** once during playback.
- The **REP** symbol appears, flashing, on the display.

To repeat a folder on the CD:

- Press **↺** twice consecutively during playback.
- The **REP FOLDER** symbol appears constantly on the display.

To repeat the entire CD:

- Press **↺** 3 times consecutively during playback.
- The **REP** symbol appears constantly on the display.

RANDOM MODE (*random playback*)

- Press **↺** 4 times consecutively during playback.
- The **RAND** symbol appears on the display.

PROGRAM MODE

Allows you to create a playlist in order to play a selection of tracks successively in **CD** or **USB** mode. The list may contain up to 20 tracks with a standard CD and may contain up to 99 tracks with an MP3 CD or an MP3 USB stick.

To start programming in **CD** mode, for example:

- Press the **MODE** button to select **CD** mode.
- Press **■** to stop playback and display the total number of tracks.
- Press the **PROG** button and the display shows **P01**, which is the first channel in the playback list.
- Press the **⏮** or **⏭** buttons immediately to select the desired track.
- Press the **PROG** button immediately and the display shows **P02**, which is the second channel in the playback list.
- Press the **⏮** or **⏭** buttons immediately to select the desired track.
- Press the **PROG** button immediately to go to the next channel.
- The display moves to channel **P03**: You can then store the tracks in the order you have chosen.
- Once selection is finished, press the **▶||** button to start playback or to pause it.
- Press **■** once to stop playback.
- Press **■** twice to exit programming mode.

AUXILIARY CONNECTOR

The device can be used to connect another audio device, typically a phone.

- Use a 3.5 mm jack cable (not provided) to connect the audio device to the **AUX** jack on the **CD** player.
- Press **MODE** once or multiple times to display **AU** and play music originating from the external audio peripheral (MP3 player, phone, etc.).
- Start and control track playback on the phone.
- Adjust the volume on the phone.
- Press the **VOL +** and **VOL -** buttons to adjust the CD-USB player volume.

HEADPHONE JACK



Listening to music at maximum volume may damage sensitive ears. Take precautions before putting on headphones:

- Take the headphones in your hands before putting them on your head.
- Adjust the volume of the radio CD player to roughly one third.
- Connect the headphones to the  jack.
- Start the radio CD player playing and check that the sound is coming out of the headphones.
- Put the headphones on.
- Adjust the volume to suit your taste.

BATTERY OPERATION

Average battery life when using alkaline batteries is around 12 h. This is why we recommend using rechargeable batteries.

TECHNICAL SPECIFICATIONS

USB port:

- Accepts all peripherals which act like USB sticks

Sound:

- 2 x 3 W
- Audio system: Stereo
- Volume control
- 3.5 mm headphone jack (32 Ω)

Tuner:

- FM radio
- Frequencies: 87.5 – 108 MHz
- Manual control and automatic search.

CD:

- CD, CD-R, CD-RW playback

CD and USB port:

- MP3 file playback
- Programmable tracks
- Repeat and random playback functions

AUX input:

- The 3.5 mm auxiliary input jack (AUX) allows for connection of the audio output from a device (e.g.: headphone output from an MP3 player – phone, etc.)

Power supply:

- 230 V \sim 50 Hz on mains power or 6 x type C / LR14 1.2-1.5 V batteries (not provided)

Power consumption:

- Max. 12 W while switched on
- 1 W in off mode

Accessories provided:

- Power cable
- User manual

Normative markings, including CE, on the base of the device.



CAUTION: This device is a class 1 laser product. In order to ensure ongoing safety, do not remove any covers and do not attempt to access the interior of the device. Entrust any repairs to a qualified person.



In order to prevent possible hearing damage, do not listen to music at a high volume for long periods of time.



www.metronic.com/a/garantie.php



This logo indicates that devices may not be disposed of with household waste at the end of their life. The hazardous substances which they are likely to contain are harmful to health and the environment. Return these devices to your distributor or make use of the selective collection methods provided by your community.



Alternative current



Double or reinforced insulation



For indoor use only



The undersigned, METRONIC, declares that the radio CD 477403 type radio equipment complies with Directive 2014/53/EU. The full text of the EU declaration of conformity is available at the following URL:
<https://medias.metronic.com/doc/477403-ncg3cf-doc.pdf>

The device may temporarily develop faults or switch off in an environment which is subject to electrostatic discharge. This situation requires intervention by the user, typically a device reboot carried out by disconnecting it and reconnecting it to the power source. Turning the device on and returning it to the

TECHNICAL SUPPORT

MOOOV, a METRONIC Group brand: hotline@metronic.com Please have the following information ready before calling:







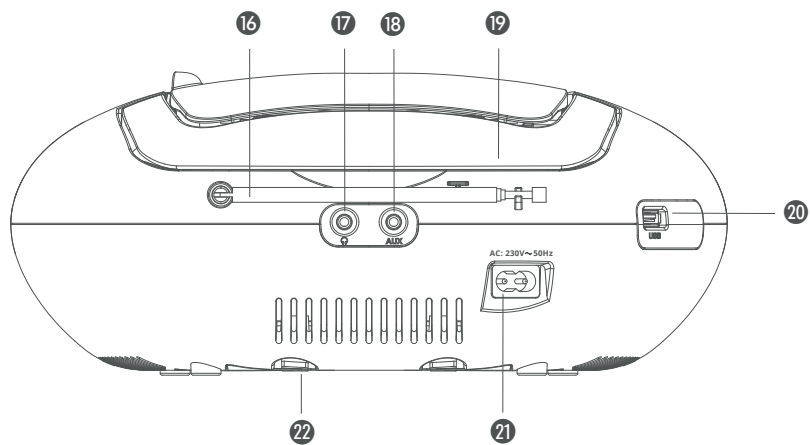
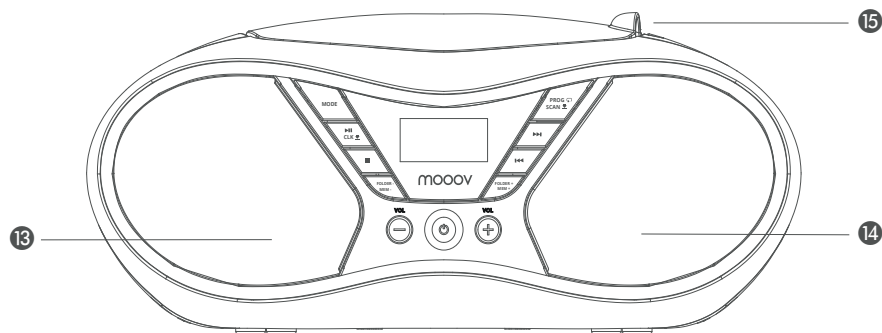
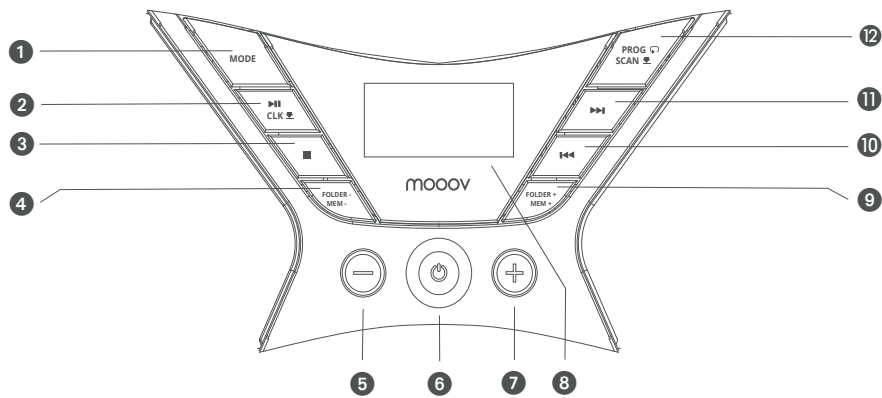

Soft Grey CD player (477403)

Pop Purple CD player (477404)



100, rue Gilles de Gennes 37310 TAUXIGNY FRANCE - Made outside EU



1	MODE	Selettore cd / USB / AU / rAd
2		PLAY o PAUSA / CLK  : regolazione dell'ora (pressione prolungata)
3		Stop
4		FOLDER - : cartella precedente / MEM - : radio memorizzata precedente
5	VOL -	Volume -
6		ON - OFF
7	VOL +	Volume +
8		Display LCD : visualizza le informazioni della lettura in corso (modalità, numero della traccia, etc...)
9		FOLDER + : cartella successiva / MEM + : radio memorizzata successiva
10		Traccia precedente o frequenza FM precedente / Indietro veloce (pressione prolungata)
11		Traccia successiva o frequenza FM successiva / Avanti veloce (pressione prolungata)
12	PROG	Creazione di una playlist /  : funzione repeat per traccia, cartella o tutto e Funzione Random (casuale) / SCAN  (pressione prolungata) : lancia la ricerca automatica delle stazioni radio
13		Altoparlante sinistro
14		Altoparlante destro
15		Sportello CD
16		Antenna FM
17		Uscita cuffie jack 3.5mm - impedenza 32Ω.
18	AUX	Ingresso AUX
19		Maniglia
20	USB	Porta USB
21		Connettore d'alimentazione da rete
22		Comparto pile/ 6x 1,2-1,5V tipo C / LR14 (non fornite)

COLLEGAMENTI



Collega il dispositivo alla rete elettrica.

Funzionamento a pile: apri il vano batterie, inserisci 6 pile tipo C/LR14 rispettando lo schema di polarità indicato.



ASCOLTARE LA RADIO

- Se il dispositivo è spento, premi il tasto  per accenderlo.
- Premi **MODE** per selezionare la modalità **rAd**.
- Regola il volume.
- Estendi l'antenna FM.

Cercare manualmente una stazione radio e memorizzarla

- Premi i tasti  o  fino a trovare la stazione radio desiderata.
- Quindi premi **PROG** per visualizzare il numero di uno slot libero, ad esempio = **P01**.
- Premi immediatamente i tasti **MEM -** e **MEM +** per scegliere la posizione desiderata tra **P01** e **P20**.
- Premi di nuovo **PROG** per uscire dalla programmazione.
- Ripeti queste operazioni per memorizzare le altre stazioni.
- I tasti **MEM -** e **MEM +** consentono poi di accedere alle stazioni memorizzate.





Cercare automaticamente una stazione radio e memorizzarla

- Tieni premuto i tasti  o : parte la ricerca automatica e si ferma alla prima stazione radio ricevuta correttamente.
- Quando trovi una stazione desiderata, premi **PROG** per visualizzare il numero di uno slot libero, ad esempio = **P01**.
- Premi immediatamente i tasti **MEM -** e **MEM +** per scegliere la posizione desiderata tra **P01** e **P20**.
- Premi di nuovo **PROG** per uscire dalla programmazione.
- Ripeti queste operazioni per memorizzare le altre stazioni.
- I tasti **MEM -** e **MEM +** consentono poi di accedere alle stazioni memorizzate.

Cercare automaticamente tutte le stazioni





- Premi il tasto **SCAN** per 2 secondi per avviare la ricerca automatica.
- Quando il sintonizzatore trova una stazione, la memorizza automaticamente (fino a 20 stazioni).
- I tasti **MEM -** e **MEM +** consentono poi di accedere alle stazioni memorizzate.

ASCOLTARE I CD

- Premi **MODE** per selezionare la modalità **Cd**.
- Apri lo sportello del CD (n°15).
- Inserisci il CD nell'unità e richiudi lo sportello. Il numero totale di tracce appare sul display dopo alcuni secondi.
- La riproduzione inizia automaticamente dalla traccia 1.
- Premi i tasti  o  per selezionare la traccia desiderata.
- Per avanzare o riavvolgere rapidamente, premi a lungo i tasti  o .

ASCOLTARE LA MUSICA DALLA PORTA USB

Inserisci un supporto USB nella porta n°20.

- Premi **MODE** per selezionare la modalità **USB**.
- Il display lampeggia e dopo alcuni secondi compare il numero delle tracce.
- La lettura parte automaticamente dalla traccia 1.
- Premi  o  per seleziona la traccia desiderata.
- Per avanzare o riavvolgere rapidamente, premi a lungo  o .
- Premi i tasti **VOL +** e **VOL -** per regolare il volume.
- Per interrompere la riproduzione, premi  e rimuovi il supporto USB.

NOTA: i supporti USB devono essere formattati in FAT.

ALTRE FUNZIONI

MODALITÀ REPEAT

Per tornare alla traccia corrente

- Durante la riproduzione, premi una volta il tasto ↶.
- Sul display lampeggia **REP**.

Per tornare ad una cartella

- Durante la riproduzione, premi 2 volte di seguito il tasto ↶.
- Sul display appare fisso **REP FOLDER**.

Per ripetere il loop dell'intero disco

- Durante la riproduzione, premi 3 volte di seguito il tasto ↶.
- Sul display appare fisso **REP**.

MODALITÀ RANDOM (CASUALE)

- Durante la riproduzione, premi 4 volte di seguito il tasto ↶.
- Sul display appare fisso **RAND**.

MODALITÀ PROGRAM

Permette di creare una playlist per riprodurre successivamente una selezione di tracce in modalità **Cd** o **USB**. L'elenco può contenere fino a 20 tracce con un CD standard e fino a 99 con un CD MP3/ Supporto USB MP3.

Per avviare una playlist, ad esempio in modalità **Cd**:

- Premi il tasto **MODE** per selezionare la modalità **Cd**.
- Premi ■ per interrompere la riproduzione e visualizzare il numero totale delle tracce.
- Premi il tasto **PROG**: il display mostra **P01** che è il primo canale della playlist.
- Premi immediatamente il tasto ◀◀ o ▶▶ per selezionare la traccia desiderata.
- Premi immediatamente il tasto **PROG**: il display indica **P02** che è il secondo canale nella playlist.
- Ripeti queste operazioni per tutte le tracce della playlist.
- Al termine della selezione, premi il ▶▶ per avviare o mettere in pausa la riproduzione.
- Premi una volta ■ per interrompere la riproduzione
- Premi due volte ■ per uscire dalla programmazione.

INGRESSO AUX

E' possibile collegare un dispositivo audio esterno, ad esempio uno smartphone, al lettore CD Soft Grey.

- Utilizza un cavo jack 3,5mm (non fornito) per collegare il dispositivo audio all'ingresso **AUX** del lettore CD.
- Premi **MODE** una o più volte fino a visualizzare **AU** e riprodurre la musica dal dispositivo audio esterno.
- Avvia e gestisci la riproduzione dei brani dal dispositivo esterno.
- Premi i tasti **VOL +** e **VOL -** per regolare il volume del lettore CD.

USCITA CUFFIE



Al massimo del volume, l'ascolto può danneggiare le orecchie.

Prendi le seguenti precauzioni prima di indossare le cuffie:

- Tieni le cuffie tra le mani, senza indossarle.
- Regola il volume del lettore CD a circa un terzo.
- Collega le cuffie all'uscita .
- Accendi il lettore CD e controlla che il suono esca dalle cuffie.
- Indossa le cuffie e regola il volume a tuo piacimento.

FUNZIONAMENTO A PILE

La durata media della batteria utilizzando pile alcaline è di circa 12 ore.

Per questo consigliamo l'uso di batterie ricaricabili.

CARATTERISTICHE TECNICHE

Porta USB:

- Accetta tutte le periferiche che si comportano come supporti USB

Suono

- 2x3W
- Diffusione sonora: stereo
- Regolazione del volume
- Jack per cuffie da 3,5 mm (32Ω)

Tuner

- FM Radio
- Frequenze: 87,5-108 MHz
- Ricerca delle frequenze manuale e automatica

CD

- Riproduzione CD, CD-R, CD-RW

CD e porta USB

- Riproduce file MP3
- Playlist
- Funzione repeat e random

Ingresso AUX

- L'ingresso AUX jack 3,5mm consente di collegare l'uscita audio di un dispositivo esterno (ad esempio: lettore MP3 – smartphone, ecc...)

Alimentazione

- Con alimentazione da rete 230V ~ 50Hz o pile tipo 1,2-1,5 V x6 - C/LR14 (non fornite)

Consumo

- 12W max in funzione
- 1 W in stand-by

Accessori in dotazione

- Cavo di rete

Marche normative, incluso CE, sotto l'apparecchio.



ATTENZIONE : l'apparecchio è un prodotto laser di Classe 1. Per garantire una costante sicurezza, non aprire l'apparecchio. In caso di guasto rivolgersi a centri specializzati qualificati.



A piena potenza, l'ascolto prolungato del dispositivo può danneggiare l'orecchio dell'utente.



GARANZIA : Il prodotto è coperto dalla garanzia legale del venditore di 24 mesi per difetti di conformità prevista dagli articoli 128 e ss. del D.Lgs. n. 206/2005 (Codice del Consumo). **ATTENZIONE**: La garanzia non è valida senza lo scontrino o la ricevuta fiscale di acquisto. www.metronic.com/a/garantie.php

INFORMAZIONE AGLI UTENTI DI APPARECCHIATURE DOMESTICHE



Ai sensi dell'art. 26 del Decreto Legislativo 14 marzo 2014, n. 49 «Attuazione della Direttiva 2012/19/UE sui rifiuti di apparecchiature elettriche ed elettroniche (RAEE)» e del Decreto Legislativo 188 del 20 novembre 2008.

Il simbolo del cassonetto barrato riportato sull'apparecchiatura o sulla sua confezione indica che il prodotto alla fine della propria vita utile, incluso della batteria non rimovibile, deve essere raccolto separatamente dagli altri rifiuti per permettere un adeguato trattamento e riciclo.

L'utente dovrà, pertanto, conferire gratuitamente l'apparecchiatura giunta a fine vita agli idonei centri comunali di raccolta differenziata dei rifiuti elettrici ed elettronici, oppure riconsegnarla al rivenditore secondo le seguenti modalità:

- per apparecchiature di piccole dimensioni, ovvero con almeno un lato esterno non superiore a 25 cm, è prevista la consegna gratuita senza obbligo di acquisto presso i negozi con una superficie di vendita delle apparecchiature elettriche ed elettroniche superiore ai 400 mq. Per negozi con dimensioni inferiori, tale modalità è facoltativa.

- per apparecchiature con dimensioni superiori a 25 cm, è prevista la consegna in tutti i punti di vendita in modalità 1control, ovvero la consegna al rivenditore potrà avvenire solo all'atto dell'acquisto di un nuovo prodotto equivalente, in ragione di uno a uno.

L'adeguata raccolta differenziata per l'avvio successivo dell'apparecchiatura dismessa al riciclaggio, al trattamento e allo smaltimento ambientalmente compatibile contribuisce ad evitare possibili effetti negativi sull'ambiente e sulla salute e favorisce il reimpiego e/o riciclo dei materiali di cui è composta l'apparecchiatura.

Lo smaltimento abusivo di apparecchiature, pile ed accumulatori da parte dell'utente comporta l'applicazione delle sanzioni di cui alla corrente normativa di legge.



Corrente alternata



Doppio isolamento o rinforzato



Utilizzo unicamente interno



Metronic Italia Srl, dichiara che l'apparecchiatura radio del tipo radio CD 477403 è conforme alla direttiva 2014/53/UE. Il testo completo della dichiarazione di conformità UE è disponibile al seguente indirizzo Internet:

<https://medias.metronic.com/doc/477403-ncg3cf-doc.pdf>

In un ambiente con scariche elettrostatiche, l'apparecchiatura può temporaneamente non funzionare correttamente o spegnersi. Questa situazione richiede l'intervento dell'utente, tipicamente un reset dell'apparecchiatura azionata da disconnessione e riconnessione alla fonte dell'alimentazione. Quindi accendere l'apparecchio e riportarlo alla modalità operativa desiderata.







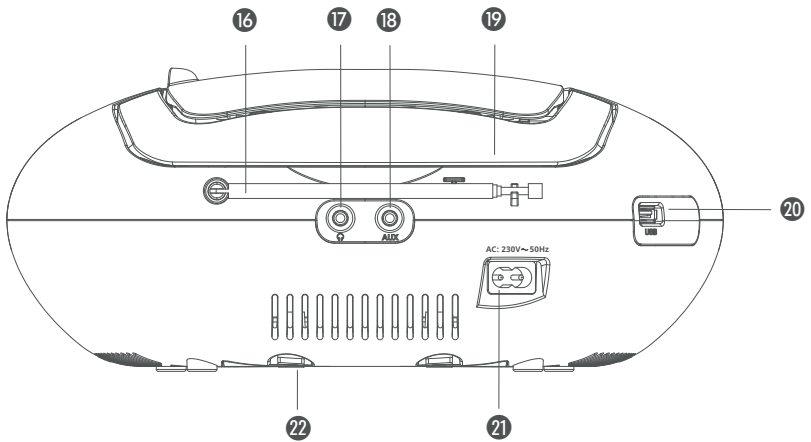
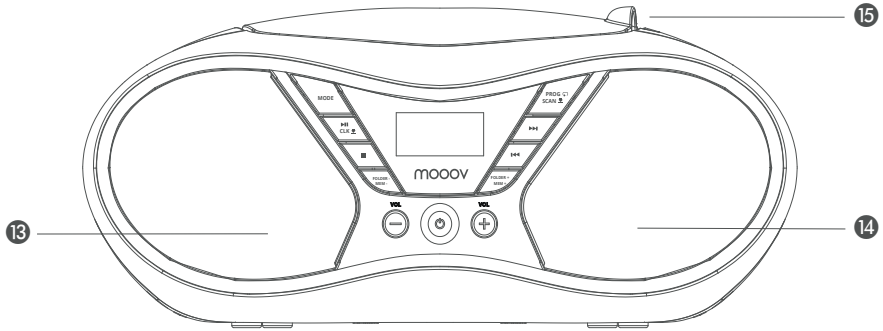
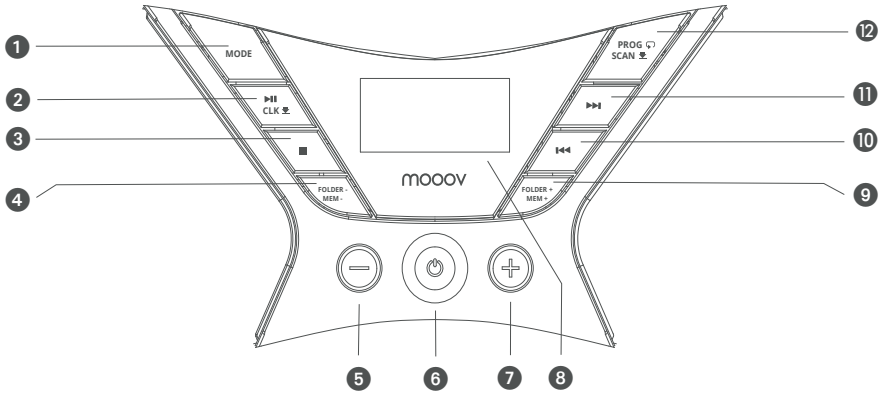

ASSISTANCE TECHNIQUE

MOOOV, un marchio del gruppo METRONIC : Telefono **02 94 94 36 91** / tecnico@metronic.com

moov

Importato da METRONIC ITALIA SRL - Via Marconi 31 - 20071 Vermezzo con Zelo (MI) ITALIA
MADE OUTSIDE EU



1	MODE	Selector cd / USB / AU / rAd
2		Reproducción ó pausa /  CLK : Ajustar la hora (pulsación larga)
3		Stop
4		FOLDER - : Carpeta anterior / MEM - : Anterior emisora memorizada
5	VOL -	Volumen -
6		Encender - Apagar
7	VOL +	Volumen +
8		Pantalla LCD : Muestra información de la reproducción (modo, número de pista, etc...)
9		FOLDER + : Carpeta siguiente / MEM + : Siguiente emisora memorizada
10		Track anterior ó emisora FM anterior paso a paso / Retroceso rápido (pulsación larga)
11		Track siguiente ó emisora FM siguiente paso a paso / Avance rápido (pulsación larga)
12	PROG	Creación de una playlist /  : Función repetir por track, por carpeta, todo y función Random (reproducción aleatoria) / SCAN  (pulsación larga) : Lanza la búsqueda automática de emisoras
13		Altavoz izquierdo
14		Altavoz derecho
15		Tapa del disco
16		Antena FM
17		Salida auricular 3.5mm impedancia 32Ω. Antes de conectar un auricular, ajustar el volumen al mínimo y luego ajustarlo según necesidad.
18	AUX	Toma auxiliar
19		Asa
20	USB	Puerto USB
21		Conector de alimentación eléctrica
22		Compartimento para pilas/ 6x 1,2-1,5V tipo C / LR14 (no incluidas)

CONEXIONES



Conectar el aparato a la corriente.

Funcionamiento con pilas : abrir el compartimento para pilas, insertar 6 pilas de tipo C / LR14 respetando el esquema de polaridad indicado.



ESCUCHAR LA RADIO

- Si el aparato está apagado, pulsar  y el aparato se enciende.
- Pulsar **MODE** para seleccionar el modo **rAd**.
- Ajustar el volumen.
- Desplegar la antena **FM**.

Buscar manualmente una emisora y memorizarla :

- Pulsar paso a paso las teclas  ó .
- Cuando encuentra una emisora, pulsar **PROG** para mostrar el número de presintonía libre, ejemplo = **P01**.
- Inmediatamente pulsar las teclas **MEM -** y **MEM +** paso a paso para elegir la ubicación deseada entre **P01** y **P20**.
- Inmediatamente pulsar **PROG** nuevamente para salir de la programación.
- Repetir estos ajustes para memorizar las otras estaciones.
- Las teclas **MEM -** y **MEM +** permiten acceder a las emisoras memorizadas.







Buscar automáticamente una emisora y almacenarla :

- Pulsación larga en  ó . La búsqueda automática inicia y para en la primera emisora recibida correctamente.
- Cuando encuentra una emisora, pulsar **PROG** para mostrar el número de presintonía libre, ejemplo = **P01**.
- Inmediatamente pulsar las teclas **MEM -** y **MEM +** paso a paso para elegir la ubicación deseada entre **P01** y **P20**.
- Inmediatamente pulsar **PROG** nuevamente para salir de la programación.
- Repetir estos ajustes para memorizar las otras estaciones.
- Las teclas **MEM -** y **MEM +** permiten acceder a las emisoras memorizadas.

Buscar automáticamente todas las emisoras :

- Pulsar **SCAN** durante 2 segundos para lanzar la búsqueda automática.
- Cuando el tuner encuentra una emisora, la memoriza automáticamente (hasta 20 emisoras).
- Las teclas **MEM -** y **MEM +** permiten acceder a las emisoras memorizadas.

ESCUCHAR CDs

- Si el aparato está apagado, pulsar  y el aparato se enciende.
- Pulsar **MODE** para seleccionar el modo **cd**.
- Abrir la tapa (15 pág. 2).
- Introducir un CD (parte grabada hacia abajo) en el lector. Cerrar la tapa. El número total de tracks aparece en la pantalla después de algunos segundos.
- La reproducción se lanza automáticamente desde la pista 1.
- Pulsar  ó  para seleccionar el track deseado.
- Para avanzar ó retroceder rápidamente, pulsación larga en  ó .
- La tecla  permite pausar y reanudar la reproducción.
- Pulsar  para parar la reproducción.

ESCUCHAR MÚSICA DESDE UN PUERTO USB

Insertar la llave en el puerto **USB**.

Si el aparato está apagado, pulsar  y el aparato se enciende.

- Pulsar **MODE** para seleccionar el modo **USB**.
- La pantalla parpadea y después de unos segundos aparece el número total de tracks.

- La reproducción se lanza automáticamente desde la pista 1.
- Pulsar **◀◀** ó **▶▶** para seleccionar el track deseado.
- Para avanzar ó retroceder rápidamente, pulsación larga en **◀◀** ó **▶▶**.
- Pulsar **VOL +** y **VOL -** para ajustar el volumen.
- Pulsar **■** para parar la reproducción y retirar la llave **USB**.
- NOTA : las llaves **USB** deben estar formateadas en FAT.

FUNCIONES ESPECIALES

Modo REPEAT

Para repetir el track en curso :

- Durante la reproducción, pulsar 1 vez **↻**.
- El símbolo **REP** parpadea en la pantalla.

Para repetir una carpeta del disco :

- Durante la reproducción, pulsar 2 veces seguidas **↻**.
- El símbolo **REP FOLDER** aparece fijo en pantalla.

Para repetir todo el disco :

- Durante la reproducción, pulsar 2 veces seguidas **↻**.
- El símbolo **REP** parpadea en la pantalla.

MODO RANDOM (reproducción aleatoria)

- Durante la reproducción, pulsar 4 veces seguidas **↻**.
- Aparece **RAND** en pantalla.

MODO PROGRAM

Permite crear una lista de reproducción para reproducir sucesivamente una selección de títulos en modo **Cd** o **USB**. La lista puede contener hasta 20 títulos con un CD estándar y puede contener hasta 99 títulos con un CD MP3, una memoria USB MP3.

Para iniciar una programación de ejemplo en modo **cd** :

- Pulsar **MODE** para seleccionar el modo **cd**.
- Pulsar **■** para parar la reproducción y mostrar el número total de tracks.
- Pulsar **PROG** y la pantalla indica **P01** que es el primer canal de la lista de reproducción.
- Pulsar **◀◀** ó **▶▶** sin esperar para seleccionar el track deseado.
- Inmediatamente presione el botón **PROG** y la pantalla indica **P02** que es el segundo canal de la lista de reproducción.
- Pulsar **◀◀** ó **▶▶** sin esperar para seleccionar el track deseado.
- Inmediatamente presione el botón **PROG** para pasar al siguiente canal.
- La pantalla pasa al canal **P03** : De este modo, puede memorizar las pistas en el orden que haya elegido.
- Cuando la selección esté completa, presione el botón **▶▶** para iniciar o pausar la reproducción.
- Pulsar **■** para parar la reproducción.
- Pulsar dos veces **■** para salir de la programación.

CONECTOR AUXILIAR

El dispositivo se puede utilizar para conectar otro dispositivo de audio, normalmente un teléfono.

- Utilice un cable jack de 3,5 mm (no incluido) para conectar el dispositivo de audio a la toma **AUX** del reproductor de CD.
- Presione **MODE** una o más veces para mostrar **AU** y reproducir música desde el dispositivo de audio externo (reproductor de MP3, teléfono, etc.).
- Iniciar y administrar la reproducción de pistas en el teléfono.
- Ajustar el volumen del teléfono.
- Pulsar **VOL +** y **VOL -** para ajustar el volumen del reproductor CD-USB.

SALIDA PARA AURICULAR



Al volumen máximo, escuchar puede dañar los oídos sensibles.

Tome las siguientes precauciones antes de colocarse los auriculares en los oídos :

- Sostenga el casco en sus manos, sin apoyarlo sobre su cabeza.
- Ajuste el volumen del Radio-CD a un tercio aproximadamente.
- Enchufe los auriculares en la salida .
- Ponga el Radio-CD y compruebe que el sonido sale por los auriculares.
- Poner el casco en las orejas.
- Ajuste el volumen a tu gusto

FUNCIONAMIENTO CON PILAS

La duración media de las pilas con pilas alcalinas es de aproximadamente 12 horas. Por eso recomendamos el uso de pilas recargables.

CARACTERÍSTICAS TÉCNICAS

Puerto USB :

- Acepta todos los periféricos que se comportan como memorias USB

Sonido :

- 2 x 3W
- Sistema audio : estéreo
- Ajuste de volumen
- Toma auricular 3.5mm (32 Ω)

Tuner :

- Radio FM
- Frecuencias : 87,5-108MHz
- Ajuste manual y búsqueda automática.

CD :

- Reproduce CD, CD-R, CD-RW

CD y puerto USB :

- Reproduce ficheros MP3
- Pistas programables
- Función repetición y reproducción aleatoria

Entrada AUX :

- La entrada auxiliar jack 3.5mm (AUX) permite conectar la salida audio de un aparato (Ejemplo : salida auricular de un reproductor MP3 – teléfono, etc...)

Alimentación :

- Eléctrica 230V ~ 50Hz ó pilas 1,2-1.5 V x6 tipo - C/LR14 (no incluidas)

Consumo :

- 12 W máx. en funcionamiento
- 1 W en standby

Accesorios incluidos :

- Cable alimentador
- Manual de instrucciones

Marcas obligatorias, como **CE**, en la parte inferior del aparato.



ATENCIÓN : Este aparato es un producto laser de Clase 1. Para garantizar una seguridad constante, no retire ninguna de las tapas y no intente acceder al interior del aparato. Para cualquier reparación, diríjase a un especialista cualificado.



Para evitar un posible daño auditivo, no escuche a un volumen alto durante mucho tiempo.



www.metronic.com/a/garantie.php



Este logotipo significa que no debe tirar los aparatos averiados o ya usados con la basura ordinaria. Estos aparatos son susceptibles de contener sustancias peligrosas que pueden perjudicar la salud y el medio ambiente. Exija la recogida de estos aparatos por su distribuidor o bien utilice los medios de recogida selectiva que están a su disposición en su localidad.



Corriente alterna



Aislamiento doble o reforzado



Utilización sólo en interior



El abajo firmante, METRONIC, declara que el equipo eléctrico radio de tipo radio CD 477403 cumple con la directiva 2014/53/EU. El texto completo de la declaración UE de conformidad está disponible en la siguiente dirección de Internet: <https://medias.metronic.com/doc/477403-ngc3cf-doc.pdf>

En un entorno sujeto a descargas electrostáticas, el equipo puede funcionar mal temporalmente o incluso apagarse. Esta situación requiere la intervención del usuario, normalmente un reinicio del equipo mediante desconexión y luego una reconexión a la fuente de alimentación. Luego simplemente encienda el equipo y vuelva a ponerlo en el modo de funcionamiento deseado. Debido a que el cable de alimentación se utiliza como dispositivo de conexión, debe permanecer fácilmente accesible.



ASISTENCIA TÉCNICA

MOOOV, una marca del grupo METRONIC : +34 93 713 26 25 / soporte@metronic.com







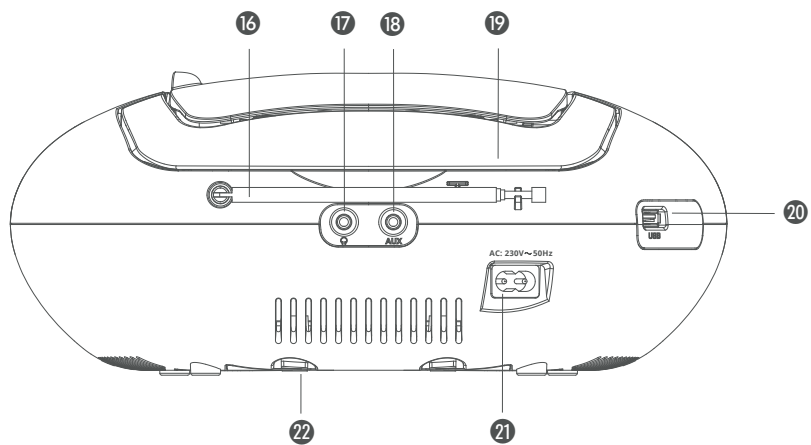
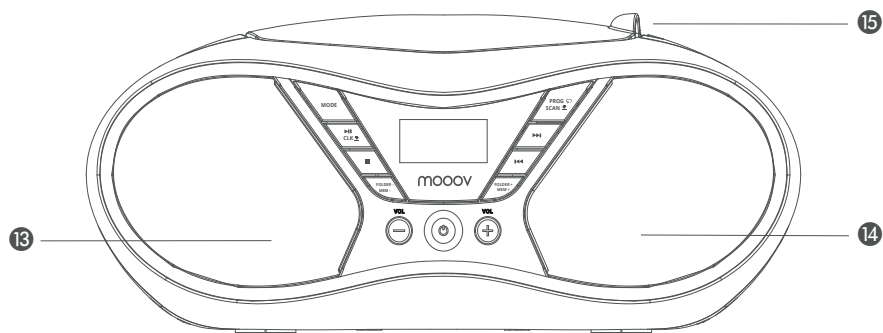
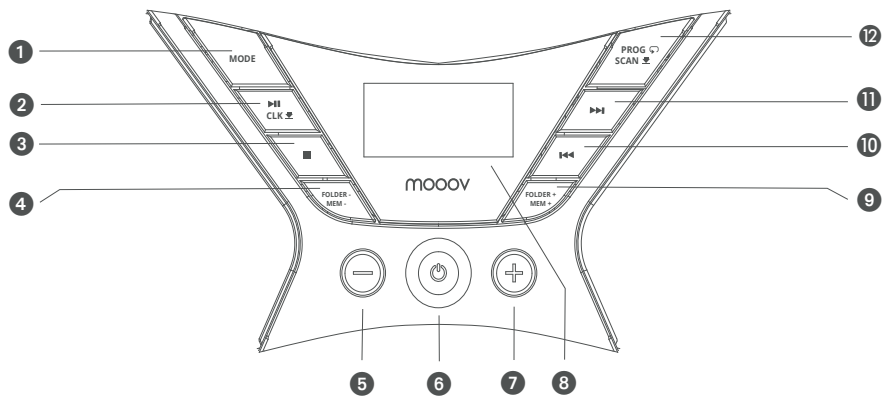

Verifique todas las informaciones antes de llamar :

Radio CD Soft Grey (477403)

Radio CD Pop Purple (477404)

moov



1	MODE	Seletor cd / USB / AU / rAd
2		Reprodução ou pausa /  CLK : Definir hora (pressão longa)
3		Stop
4		FOLDER - : Pasta anterior / MEM - : Estação anterior memorizada
5	VOL -	Volume -
6		Acender - Apagar
7	VOL +	Volume +
8		Display LCD : Mostrar informações de reprodução (modo, número da track, etc...)
9		FOLDER + : Próxima pasta / MEM + : Estação seguinte memorizada
10		Track anterior ou estação FM anterior passo a passo / Retrocesso rápido (pressão longa)
11		Próxima faixa ou próxima estação FM passo a passo / Avanço rápido (pressão longa)
12	PROG	Criação de uma playlist /  : função de repetição por faixa, por pasta, todas e função aleatória (reprodução aleatória) / SCAN  (toque longo): inicia a busca automática de estações
13		Coluna esquerda
14		Coluna direita
15		Tampa do disco
16		Antena FM
17		Saída de auricular impedância de 3,5 mm 32Ω. Antes de conectar um auricular, coloque o volume no mínimo e ajuste conforme necessário.
18	AUX	Tomada auxiliar
19		Alça
20	USB	Porta USB
21		Conector de alimentação
22		Compartimento de pilha / 6x 1,2-1,5V tipo C / LR14 (não incluído)

CONEXÕES

Conecte o dispositivo à corrente.

Operação com bateria: abra o compartimento da bateria, insira 6 baterias tipo C / LR14 respeitando o esquema de polaridade indicado.

OUVIR O RÁDIO

- Se o aparelho estiver desligado, pressione  e o aparelho liga.
- Pressione **MODE** para selecionar o modo **rAd**.
- Ajustar o volume.
- Desdobre a antena **FM**.

Pesquise manualmente uma estação e armazene-a :

- Pressione passo a passo as teclas **◀◀** ou **▶▶**.
- Ao encontrar uma estação, pressione **PROG** para exibir o número predefinido livre, exemplo = **P01**.
- Pressione imediatamente as teclas **MEM -** e **MEM +** passo a passo para escolher o local desejado entre **P01** e **P20**.
- Imediatamente pressione **PROG** novamente para sair da programação.
- Repita essas configurações para memorizar as outras estações.
- As teclas **MEM -** e **MEM +** permitem o acesso às estações memorizadas.

Pesquise automaticamente uma estação e armazene-a :

- Mantenha pressionado **◀◀** ou **▶▶**. A busca automática começa e para na primeira estação recebida com sucesso.
- Ao encontrar uma estação, pressione **PROG** para exibir o número predefinido livre, exemplo = **P01**.
- Pressione imediatamente as teclas **MEM -** e **MEM +** passo a passo para escolher o local desejado entre **P01** e **P20**.
- Imediatamente pressione **PROG** novamente para sair da programação.
- Repita essas configurações para memorizar as outras estações.
- As teclas **MEM -** e **MEM +** permitem o acesso às estações memorizadas.

Pesquisar automaticamente todas as estações :

- Pressione **SCAN** por 2 segundos para iniciar a busca automática.
- Quando o sintonizador encontra uma estação, ele a armazena automaticamente (até 20 estações).
- As teclas **MEM -** e **MEM +** permitem o acesso às estações memorizadas.

ESCUTAR CDs

- Se o aparelho estiver desligado, pressione  e o aparelho liga.
- Pressionar **MODE** para selecionar o modo **cd**.
- Abra a tampa (15 pág. 2).
- Insira um CD (parte gravada voltada para baixo) no leitor. Feche a tampa. O número total de tracks aparece no display após alguns segundos.
- A reprodução começa automaticamente a partir do track 1.
- Track **◀◀** ou **▶▶** para selecionar o track desejado.
- Para avançar ou retroceder, pressão longa **◀◀** ou **▶▶**.
- A tecla **▶||** permite pausar e retomar a reprodução.
- Pressionar **■** para parar a reprodução.

OUVIR MÚSICA A PARTIR DE UMA PORTA USB

Insira a chave na porta **USB**.

Se o aparelho estiver desligado, pressione  e o aparelho liga.

- Pressione **MODE** para selecionar o modo **USB**.

- O visor pisca e após alguns segundos aparece o número total de tracks.
- A reprodução começa automaticamente a partir do track 1.
- Pressione **◀◀** ou **▶▶** para selecionar o track desejado.
- Para avançar ou retroceder, pressão longa **◀◀** ou **▶▶**.
- Pressionar **VOL +** e **VOL -** para ajustar o volume.
- Pressionar **■** para parar a reprodução e remover a tecla **USB**.
- NOTA: As chaves **USB** devem ser formatadas em **FAT**.

FUNÇÕES ESPECIAIS

Modo REPEAT

Para repetir o track atual :

- Durante a reprodução, pressione 1 vez **↻**.
- O símbolo **REP** pisca no visor.

Repetir uma pasta do disco :

- Durante a reprodução, pressione 2 vezes seguidas **↻**.
- O símbolo **REP FOLDER** aparece fixo no display.

Para repetir o disco inteiro :

- Durante a reprodução, pressione 2 vezes seguidas **↻**.
- O símbolo **REP** pisca no display.

MODO RANDOM (reprodução aleatória)

- Durante a reprodução, pressione 4 vezes seguidas **↻**.
- Aparece **RAND** no display.

MODO PROGRAM

Permite criar uma lista de reprodução para reproduzir sucessivamente uma seleção de títulos no modo **CD** ou **USB**. A lista pode conter até 20 títulos com um CD standard e pode conter até 99 títulos com um CD MP3, memória USB MP3.

Para iniciar um cronograma de amostra no modo **cd** :

- Pressionar **MODE** para selecionar o modo **cd**.
- Pressionar **■** para parar a reprodução e exibir o número total de tracks.
- Pressionar **PROG** e o display indica **P01** qual é o primeiro canal da playlist.
- Pressionar **◀◀** ou **▶▶** sem esperar para selecionar o track desejado.
- Pressione imediatamente o botão **PROG** e o display indica **P02** que é o segundo canal da lista de reprodução.
- Pressione **◀◀** ou **▶▶** sem esperar para selecionar o track desejado.
- Pressione imediatamente o botão **PROG** para ir para o próximo canal.
- O display vai para o canal **P03** : Desta forma, você pode memorizar os tracks na ordem que você escolheu.
- Quando a seleção estiver concluída, pressione o botão **▶▶** para iniciar ou pausar a reprodução.
- Pressione **■** para parar a reprodução.
- Pressione duas vezes **■** para sair da programação.

CONETOR AUXILIAR

O dispositivo pode ser usado para conectar outro dispositivo de áudio, geralmente um telefone.

- Use um cabo jack de 3,5 mm (não incluído) para conectar o dispositivo de áudio na tomada **AUX** do CD player.
- Pressione **MODE** uma ou mais vezes para exibir **AU** e reproduzir música do dispositivo de áudio externo (MP3 player, telefone, etc.).
- Inicie e gerencie a reprodução de tracks no telefone.
- Ajuste o volume do telefone.

SAÍDA PARA AURICULAR



No volume máximo, ouvir pode danificar ouvidos sensíveis.

Tome as seguintes precauções antes de colocar o auricular nos ouvidos :

- Segure o capacete com as mãos, sem apoiá-lo na cabeça.
- Ajuste o volume do Rádio-CD para aproximadamente um terço.
- Conecte os fones de ouvido no conector .
- Coloque o Rádio-CD e verifique se o som sai pelos fones de ouvido.
- Coloque o capacete nas orelhas.
- Ajuste o volume ao seu gosto

FUNCIONAMENTO COM PILHAS

A duração média da bateria com baterias alcalinas é de aproximadamente 12 horas.

É por isso que recomendamos o uso de baterias recarregáveis.

CARACTERÍSTICAS TÉCNICAS

Porta USB :

- Aceita todos os periféricos que se comportam como pendrives USB

Som :

- 2 x 3W
- Sistema audio : estéreo
- Ajuste de volume
- Tomada auricular 3.5mm (32 Ω)

Tuner :

- Rádio FM
- Frequências : 87,5-108MHz
- Ajuste manual e busca automática.

CD :

- Reproduz CD, CD-R, CD-RW

CD e porta USB :

- Reproduz arquivos MP3
- Tracks programáveis
- Função de repetição e reprodução aleatória

Entrada AUX :

- A entrada auxiliar jack de 3,5 mm (AUX) permite conectar a saída de áudio de um dispositivo (Exemplo: saída auricular de um MP3 player – telefone, etc...)

Alimentação :

- Elétrica 230V ~ 50Hz ou pilhas 1,2-1.5 V x6 tipo - C/LR14 (não incluídas)

Consumo :

- 12 W máx. em funcionamento
- 1 W em standby

Acessórios incluídos :

- Cabo alimentação
- Manual de instruções

Marcações obrigatórias, como **CE**, na parte inferior do aparelho.



ATENÇÃO : Este dispositivo é um produto a laser Classe 1. Para garantir uma segurança constante, não remova nenhuma das tampas e não tente acessar o dentro do aparelho. Para qualquer reparação, contacte um especialista qualificado.



Para evitar possíveis danos à audição, não ouça em volume alto por muito tempo.



www.metronic.com/a/garantie.php



Este logotipo significa que você não deve descartar dispositivos danificados ou usados no lixo comum. Esses dispositivos provavelmente contêm substâncias perigosas que podem prejudicar a saúde e o meio ambiente. Exija a coleta desses aparelhos pelo seu distribuidor ou utilize os meios de coleta seletiva que estão à sua disposição em sua localidade.



Corrente alternada



Isolamento duplo ou reforçado



Apenas para uso interno



O abaixo assinado, METRONIC, declara que o equipamento elétrico rádio tipo CD 477403 está em conformidade com a diretiva 2014/53/UE. O texto completo da declaração de conformidade da UE está disponível no seguinte endereço da Internet: <https://medias.metronic.com/doc/477403-ncg3cf-doc.pdf>

Em um ambiente sujeito a descarga eletrostática, o equipamento pode funcionar temporariamente ou até mesmo desligar. Esta situação requer intervenção do usuário, normalmente uma reinicialização do equipamento desconectando e reconectando à fonte de alimentação. Em seguida, basta ligar o equipamento e retorná-lo ao modo de operação desejado. Como o cabo de alimentação é usado como um dispositivo de conexão, ele deve permanecer facilmente acessível.



ASSISTÊNCIA TÉCNICA

MOOOV, uma marca do grupo METRONIC : +34 93 713 26 25 / suporte@metronic.com







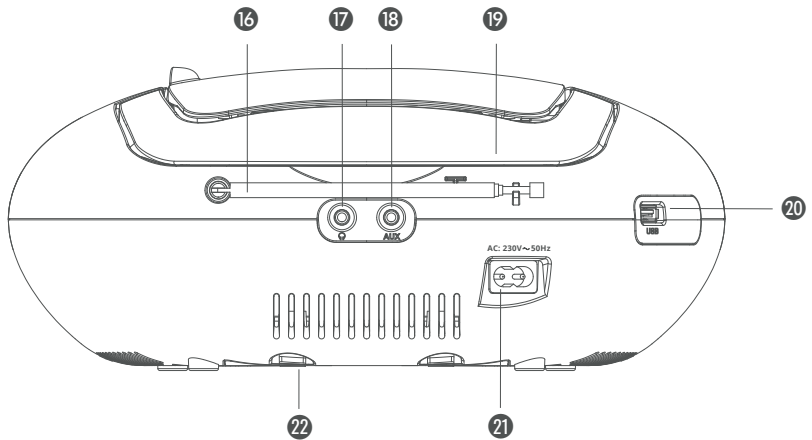
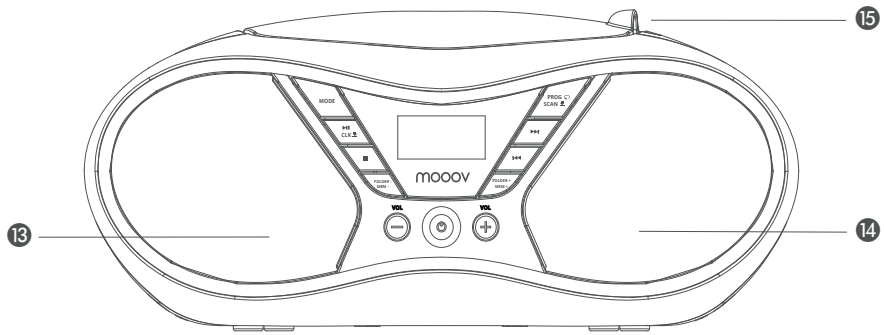
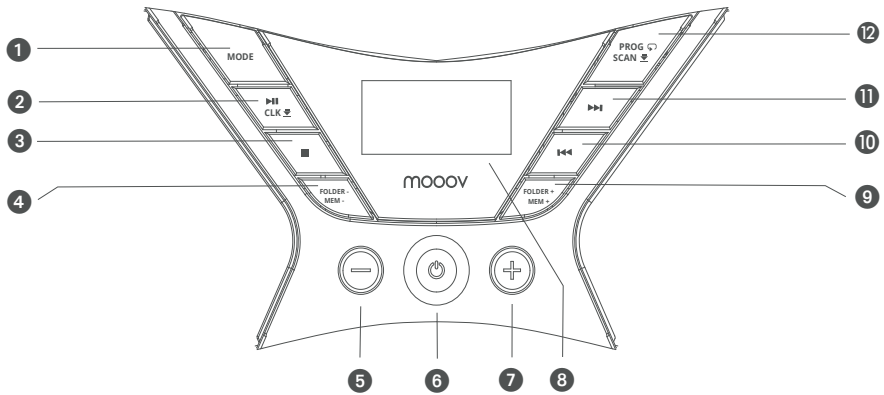

Verifique todas as informações antes de ligar :

Rádio CD Soft Grey (477403)

Rádio CD Pop Purple (477404)

moov



1	MODE	Auswahl CD / USB / AU / RADIO
2		Abspielen oder Pause / CLK  : Uhrzeit einstellen (Taste gedrückt halten)
3		Stopp
4		FOLDER - : Vorheriger Ordner / MEM - : Vorheriger gespeicherter Sender
5	VOL -	Lautstärke -
6		Ein / Aus
7	VOL +	Lautstärke +
8		LCD-Display: Zeigt die aktuellen Wiedergabedaten an (Modus, Titelnummer usw.)
9		FOLDER + : Nächster Ordner / MEM + : Nächster gespeicherter Sender
10		Vorheriger Titel oder vorherige UKW -Frequenz schrittweise / Schnellrücklauf (Taste gedrückt halten)
11		Nächster Titel oder nächste UKW -Frequenz schrittweise / Schnellvorlauf (Taste gedrückt halten)
12	PROG	Erstellung einer Playlist /  : Wiederholfunktion für Einzeltitel, für Ordner, alles und Random-Funktion (Zufallswiedergabe) / SCAN  (Taste gedrückt halten): Start des automatischen Sendersuchlaufs
13		Linker Lautsprecher
14		Rechter Lautsprecher
15		CD-Klappe
16		UKW -Antenne
17		3,5-mm-Kopfhörerausgang (Impedanz 32 Ω). Vor dem Anschließen eines Kopfhörers die Lautstärke auf Minimum stellen, danach die Lautstärke wie gewünscht einstellen.
18	AUX	Aux-Eingang
19		Henkelgriff
20	USB	USB -Anschluss
21		Netzanschluss
22		Batteriefach / 6 x 1,2-1,5 V Typ C / LR14 (nicht im Lieferumfang enthalten)

ANSCHLÜSSE



Schließen Sie das Gerät ans Stromnetz an.

Batteriebetrieb: Öffnen Sie das Batteriefach und legen Sie 6 Batterien des Typs C / LR14 ein; beachten Sie hierbei die angezeigte Polarität.



RADIO HÖREN

- Wenn das Gerät ausgeschaltet ist, drücken Sie die Taste , um es einzuschalten.
- Drücken Sie **MODE**, um den **RADIO**-Modus auszuwählen.
- Stellen Sie die Lautstärke ein.
- Richten Sie die **UKW**-Antenne aus.

Manuelle Suche und Speichern eines Senders:

- Drücken Sie schrittweise die Tasten  oder .
- Wenn ein Sender gefunden wurde, drücken Sie **PROG**, um die Nummer eines freien Speicherplatzes anzuzeigen, zum Beispiel = **P01**.
- Drücken Sie danach schrittweise die Tasten **MEM -** und **MEM +**, um den gewünschten Speicherplatz von **P01** bis **P20** auszuwählen.
- Drücken Sie danach erneut **PROG**, um die Programmierung zu verlassen.
- Wiederholen Sie diese Schritte, um weitere Sender zu speichern.
- Mit den Tasten **MEM -** und **MEM +** können Sie nun auf die gespeicherten Sender zugreifen.







Automatische Suche und Speichern eines Senders:

- Halten Sie die Taste  oder  gedrückt. Der automatische Suchlauf startet und stoppt beim ersten korrekt empfangenen Radiosender.
- Wenn der gewünschte Sender gefunden wurde, drücken Sie **PROG**, um die Nummer eines freien Speicherplatzes anzuzeigen, zum Beispiel = **P01**.
- Drücken Sie danach schrittweise die Tasten **MEM -** oder **MEM +**, um den gewünschten Speicherplatz von **P01** bis **P20** auszuwählen.
- Drücken Sie danach erneut **PROG**, um die Programmierung zu verlassen.
- Wiederholen Sie diese Schritte, um weitere Sender zu speichern.
- Mit den Tasten **MEM -** und **MEM +** können Sie nun auf die gespeicherten Sender zugreifen.

Automatische Suche aller Sender:

- Halten Sie die Taste **SCAN** 2 Sekunden lang gedrückt, um den automatischen Suchlauf zu starten.
- Wenn der Tuner einen Sender findet, speichert er ihn automatisch (bis zu 20 Sender).
- Mit den Tasten **MEM -** und **MEM +** können Sie nun auf die gespeicherten Sender zugreifen.

ABSPIELEN VON CDs

- Wenn das Gerät ausgeschaltet ist,  drücken. Das Gerät schaltet sich ein.
- Drücken Sie **MODE**, um den **CD**-Modus auszuwählen.
- Öffnen Sie den Deckel (15 auf Seite 2).
- Legen Sie eine CD (mit der Schrift nach oben) in den Player. Schließen Sie den Deckel wieder. Nach einigen Sekunden erscheint die Gesamtanzahl der Titel auf der Anzeige.
- Die Wiedergabe beginnt automatisch ab Titel 1.
- Drücken Sie die Taste  oder  um den gewünschten Titel auszuwählen.
- Zum schnellen Vor- oder Zurückspulen  oder  gedrückt halten.
- Mit der Taste  kann die Wiedergabe unterbrochen und wieder fortgesetzt werden.
- Drücken Sie  um die Wiedergabe zu beenden.

MUSIK VON EINEM USB-STICK ABSPIELEN

Schließen Sie den Stick an den **USB**-Anschluss an.

Wenn das Gerät ausgeschaltet ist,  drücken. Das Gerät schaltet sich ein.

- Drücken Sie **MODE**, um den **USB**-Modus auszuwählen.
- Die Anzeige blinkt, nach wenigen Sekunden wird die Gesamtanzahl der Titel angezeigt.
- Die Wiedergabe beginnt automatisch ab Titel 1.

- Drücken Sie die Taste **◀◀** oder **▶▶** um den gewünschten Titel auszuwählen.
- Zum schnellen Vor- oder Zurückspulen **◀◀** ou **▶▶** gedrückt halten.
- Stellen Sie mithilfe der Tasten **VOL +** und **VOL -** die Lautstärke ein.
- Zum Beenden der Wiedergabe **■** drücken und den **USB**-Stick abziehen
- HINWEIS: Der **USB**-Stick muss in FAT formatiert sein.

SPEZIELLE FUNKTIONEN

Modus REPEAT

Laufenden Titel wiederholen:

- Drücken Sie während der Wiedergabe 1 x die Taste **↶**.
- Auf der Anzeige blinkt das Symbol **REP**.

Einen Ordner wiederholen:

- Drücken Sie während der Wiedergabe 2 x nacheinander die Taste **↶**.
- Auf dem Display wird durchgängig das Symbol **REP FOLDER** angezeigt.

Gesamten Inhalt der CD wiederholen:

- Drücken Sie während der Wiedergabe 3 x nacheinander die Taste **↶**.
- Auf dem Display wird durchgängig das Symbol **REP** angezeigt.

Modus RANDOM (Zufallswiedergabe)

- Drücken Sie während der Wiedergabe 4 x nacheinander die Taste **↶**.
- Auf dem Display erscheint die Anzeige **RAND**.

MODUS PROGRAM

Damit kann eine Playlist erstellt werden, um nacheinander eine Auswahl von Titeln im **CD**- oder **USB**-Modus abzuspielen. Bei einer Standard-CD kann die Liste bis zu 20 Titel enthalten; bei einer MP3-CD oder einem MP3-USB-Stick kann die Liste bis zu 99 Titel enthalten

Starten einer Beispiel-Programmierung im **CD**-Modus:

- Drücken Sie die Taste **MODE**, um den **CD**-Modus auszuwählen
- Drücken Sie **■** um die Wiedergabe zu stoppen und die Gesamtanzahl der Titel anzuzeigen.
- Drücken Sie die Taste **PROG** Das Display zeigt **P01** an, das ist der erste Kanal der Wiedergabeliste.
- Drücken Sie sofort die Taste **◀◀** oder **▶▶** um den gewünschten Titel auszuwählen.
- Drücken Sie danach die Taste **PROG**. Das Display zeigt **P02** an, das ist der zweite Kanal der Wiedergabeliste.
- Drücken Sie sofort die Taste **◀◀** oder **▶▶** um den gewünschten Titel auszuwählen.
- Drücken Sie danach die Taste **PROG**, um zum nächsten Kanal zu wechseln.
- Die Anzeige wechselt zu Kanal **P03**: So können Sie Titel in der von Ihnen gewählten Reihenfolge speichern.
- Wenn Sie mit der Auswahl fertig sind, drücken Sie die Taste **▶▶** um die Wiedergabe zu starten oder zu unterbrechen.
- Drücken Sie einmal **■** um die Wiedergabe zu beenden.
- Drücken Sie zweimal **■** um die Programmierung zu beenden.

AUX-ANSCHLUSS

Das Gerät kann zum Anschließen eines anderen Audiogeräts, z. B. eines Smartphones, verwendet werden.

- Schließen Sie das Audiogerät mit einem 3,5-mm-Klinkenkabel (nicht im Lieferumfang enthalten) an den **AUX-Anschluss** des CD-Players an.
- Drücken Sie **MODE** einmal oder mehrmals, bis **AU** angezeigt und die Musik des externen Audiogeräts (MP3-Player, Smartphone usw.) wiedergegeben wird.
- Starten und steuern Sie die Titelwiedergabe auf dem Smartphone.
- Stellen Sie die Lautstärke am Smartphone ein.

- Stellen Sie die Lautstärke des CD-USB-Players mithilfe der Tasten **VOL +** und **VOL -** ein.

KOPFHÖRERAUSGANG

 Bei maximaler Lautstärke kann das Gehör geschädigt werden. Treffen Sie die folgenden Vorkehrungen, bevor Sie den Kopfhörer aufsetzen:

- Nehmen Sie den Kopfhörer in die Hand, ohne ihn aufzusetzen.
- Stellen Sie die Lautstärke des Radio-CD-Players etwa auf ein Drittel ein.
- Schließen Sie den Kopfhörer an den Ausgang  an.
- Starten Sie die Wiedergabe des Radio-CD-Players und überprüfen Sie, ob der Kopfhörer den Ton wiedergibt.
- Setzen Sie den Kopfhörer auf.
- Stellen Sie die Lautstärke nach Wunsch ein

BATTERIEBETRIEB

Die mittlere Betriebsdauer bei Verwendung von Alkaline-Batterien beträgt ca. 12 h. Wir empfehlen daher die Verwendung von wiederaufladbaren Akkus.

TECHNISCHE DATEN

USB-Anschluss:

- Akzeptiert alle Geräte, die sich wie USB-Sticks verhalten

Ton:

- 2 x 3 W
- Audiosystem: Stereo
- Einstellung der Lautstärke
- 3,5-mm-Kopfhöreranschluss (32 Ω)

Tuner:

- UKW-Radio
- Frequenzen: 87,5-108 MHz
- Manuelle Einstellung und automatischer Suchlauf.

CD:

- Wiedergabe von CDs, CD-Rs, CD-RWs

CD und USB-Anschluss:

- Wiedergabe von MP3-Dateien
- Programmierbare Titel
- Wiederholungs- und Zufallsfunktion

Stromversorgung:

- Der 3,5-mm-Klinkeneingang (AUX) dient zum Anschließen des Audioausgangs eines Gerätes (Beispiel: Kopfhörerausgang eines MP3-Players, Smartphones usw.)

Stromversorgung:

- Netzanschluss 230 V: \sim 50 Hz oder 6 x Batterien 1,2-1,5 V Typ C / LR14 (nicht im Lieferumfang enthalten)

Leistungsaufnahme:

- 12 W max. in Betrieb
- 1 W in ausgeschaltetem Zustand

Mitgeliefertes Zubehör:

- Netzkabel
- Bedienungsanleitung

Normenkennzeichnungen, u. a. CE, auf der Unterseite des Geräts.



ACHTUNG: Dieses Gerät ist ein Laserprodukt der Klasse 1. Um die Sicherheit dauerhaft zu gewährleisten, entfernen Sie keine der Abdeckungen und versuchen Sie nicht, sich Zugang zum Inneren des Geräts zu verschaffen. Beauftragen Sie qualifiziertes Personal mit eventuellen Reparaturen



Betreiben Sie das Gerät nicht über einen längeren Zeitraum mit hoher Lautstärke, um eine mögliche Gehörschädigung zu vermeiden



www.metronic.com/a/garantie.php



Dieses Logo bedeutet, dass nicht mehr funktionsfähige Geräte nicht mit dem Hausmüll entsorgt werden dürfen. Möglicherweise enthaltene Gefahrstoffe können der Gesundheit und der Umwelt schaden. Bringen Sie diese Geräte zu Ihrem Händler zurück oder entsorgen Sie sie über die Sammelstellen in Ihrer Stadt bzw. Gemeinde.



Wechselstrom
Innenbereich



Doppelte oder verstärkte Isolierung



Ausschließlich zur Verwendung im



Der Unterzeichnete, METRONIC, erklärt, dass das elektrische CD-Radiogerät des Typs 477403 die Bestimmungen der Richtlinie 2014/53/EU erfüllt. Der vollständige Text der EU-Konformitätserklärung ist unter der folgenden Internetadresse einsehbar: <https://medias.metronic.com/doc/477403-ncg3cf-doc.pdf>

Ist das Gerät elektrostatischer Spannung ausgesetzt, kann es zeitweise zu Störungen oder sogar zum Abschalten des Geräts kommen. Sollte dies der Fall sein, müssen Sie das Gerät durch Trennen von der Stromversorgung und erneutes Anschließen neu starten. Danach müssen Sie das Gerät lediglich wieder einschalten und den gewünschten Funktionsmodus wieder einstellen. Wenn das Netzkabel zum Anschließen des Geräts verwendet wird, muss dieses immer leicht zugänglich sein.

TECHNISCHER SUPPORT

MOOOV ist eine Marke der METRONIC Group: 02271-9047997. Halten Sie bei jedem Anruf die folgenden Informationen bereit: **CD-Player Soft Grey (477403) / CD-Player Pop Purple (477404)**



Vertrieben von Bigben Interactive DEUTSCHLAND GmbH - Walter Gropius Str. 28, 50126 Bergheim, Deutschland
Made outside EU

U vindt de versie van dit bericht in het Nederlands op de volledige versie op onze website www.metronic.com in de sectie **besoin d'aide / documentations**



Gedistribueerd door Bigben Interactive NEDERLAND b.v. - 's-Gravelandseweg 80, 1217 EW Hilversum, Nederland MADE OUTSIDE EU
Made outside EU

Hotline : customerservice@bigben-interactive.nl

moov • Een merk van de METRONIC-groep



moov®