

# FAR TOOLS®

- FR** Rénovateur extérieur (Notice originale)
- EN** Exterior renovator (Original manual translation)
- DE** Schleif- und Renoviergerät (Übersetzung aus der Originalanleitung)
- ES** Fuera renovador (Traducción del manual de instrucciones originale)
- IT** Restauratore di fuori ( Traduzione dell'avvertenza originale)
- PT** Fora renovador ( Tradução do livro de instruções original )
- NL** Buiten renovator ( Vertaling van de originele instructies )
- EL** Ἐξω ἀπὸ ἀνακαινιστὴς ( Μετάφραση ἀπὸ τὴς πρωτότυπες οδηγίες )
- PL** Poza renowatora ( Tłumaczenie z oryginalnej instrukcji )
- FI** Ulkopuolella remontoijille ( Käännös alkuperäisestä ohjeet )
- SV** Utanför renovator ( Översättning från originalinstruktioner )
- BU** Извън обновител ( Превод на оригиналната инструкция )
- DA** Udenfor renovator ( Oversættelse fra oprindelige brugsanvisning )
- RO** În afara renovator ( Traducere din instrucțiunile originale )
- RU** Вне реставратора (Перевод с оригинальной инструкции )
- TU** Yenileyen dışında ( Orijinal talimatlar çeviri )
- CS** Mimo renovátor ( Překlad z originálního návodu )
- SK** Mimo renovátor ( Preklad z originálneho návodu )
- HE** תוירוקמ תוארומה סוגרת ( קניצופיש פוחמ )
- AR** قىلصألا تاميلعلتل نم قمجرتلا ( لخصم جراخ )
- HU** Kívül renovator ( Fordítás az eredeti utasítások )
- SL** Zunaj Obnovilac ( Prevod iz izvirnih navodil )
- ET** Õues renovator ( Tõlge originaal juhiseid )
- LV** Ārpus atjaunotājs ( Tulkojumā no instrukcijas oriģinālvalodā )
- LT** Už Restorer (Vertimas iš originalių instrukcijos)
- HR** Vanjski renovator (Prijevod prema originalne upute)



**REX 200**  
Professional Machine



© FAR GROUP EUROPE



115015-D-2021025

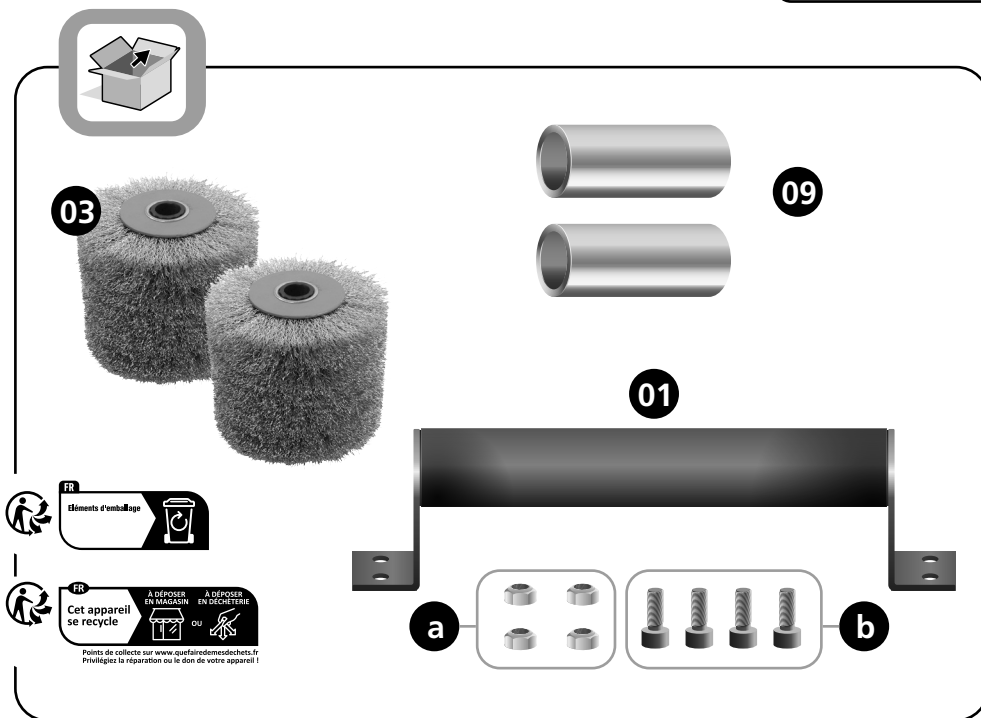
**fartools.com**



**FIG. A**



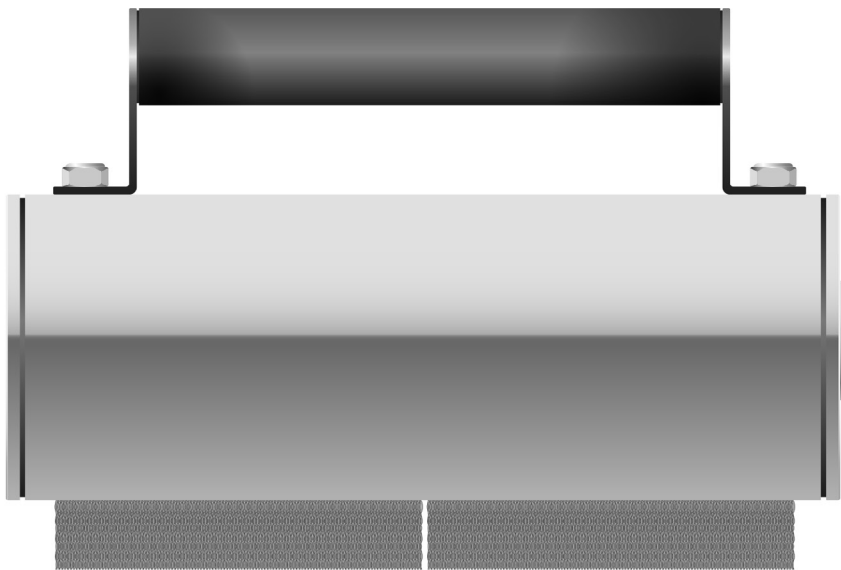
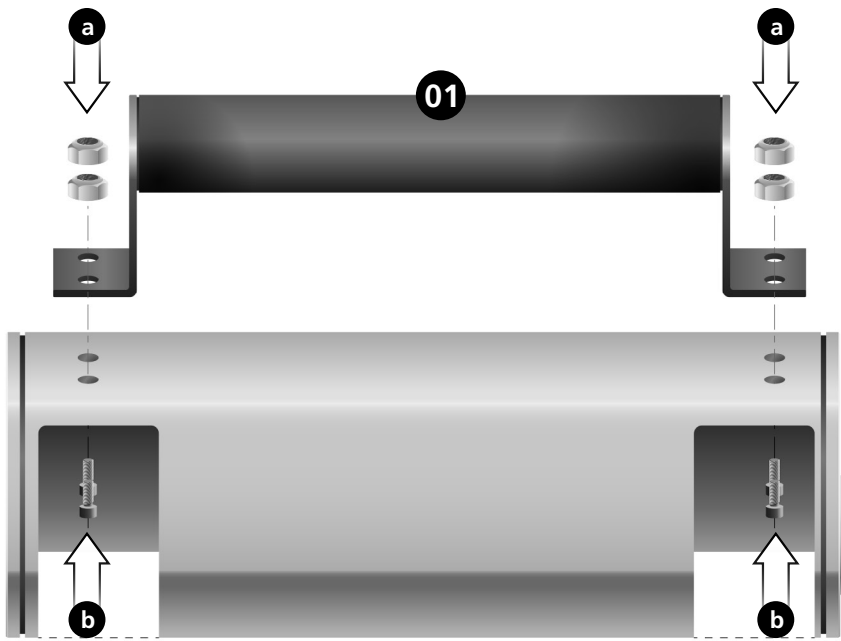
**FIG. C**

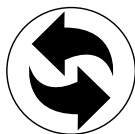
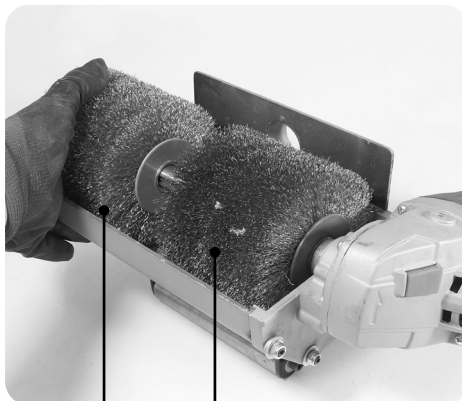
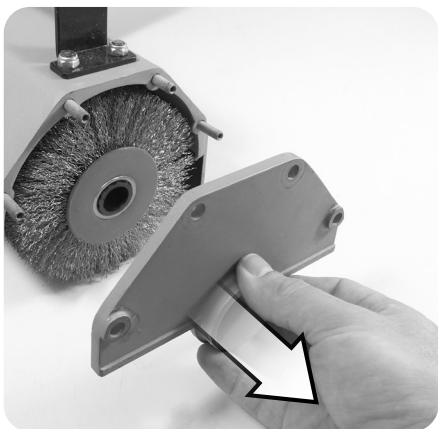
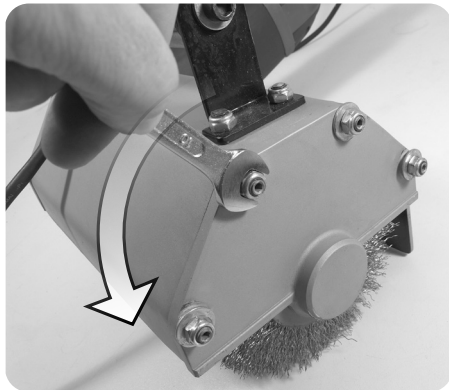
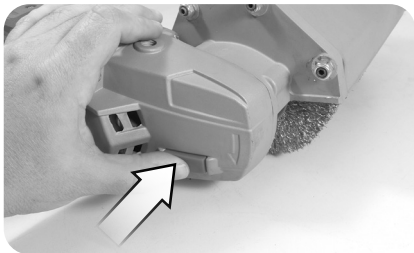




**FIG. D**

01



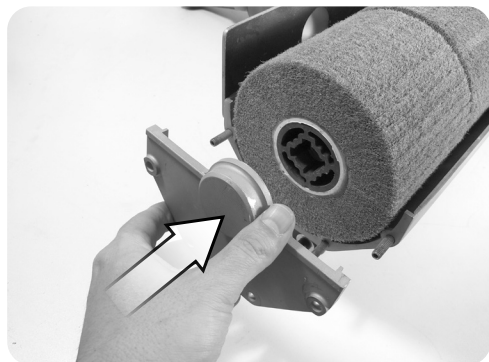
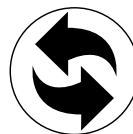


**110885 :**  
 Brosse fil laitonée 0,3 mm (x2)  
 Staalborstel messing 0,3 mm (x2)  
 0,3 mm cepillo de alambre de latón (x2)  
 0,3 millimetros escova de arame de bronze (x2)  
 0,3 millimetri spazzola metallica di ottone (x2)  
 0.3 mm brass wire brush (x2)





**110873 :**  
**Brosse fibre synthétique (x2)**  
Synthetische vezel penseel (x2)  
Pincel de fibra sintética (x2)  
Escova de fibra sintética (x2)  
Pennello in fibra sintetica (x2)  
Synthetic fiber brush (x2)

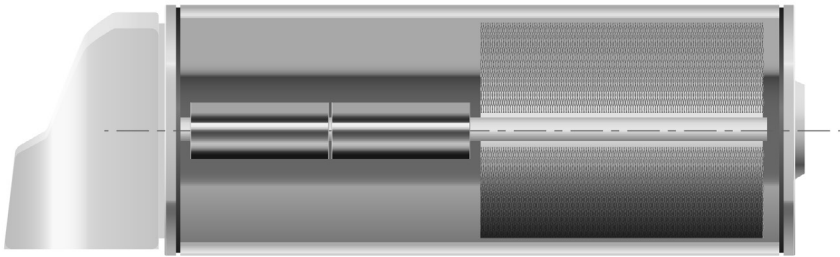




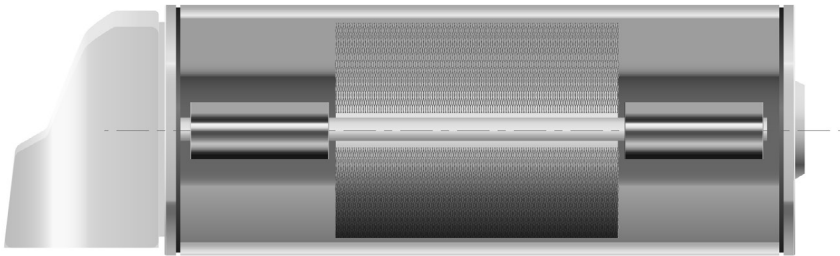
**11** x2



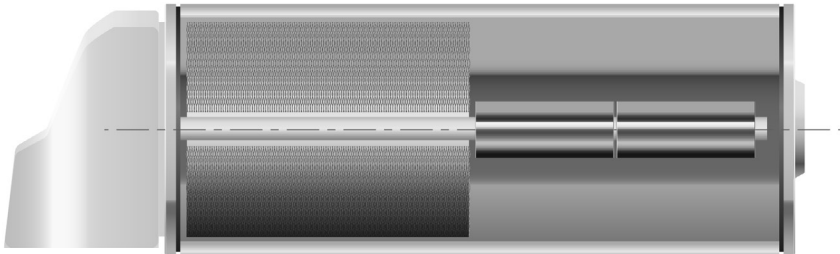
**A**

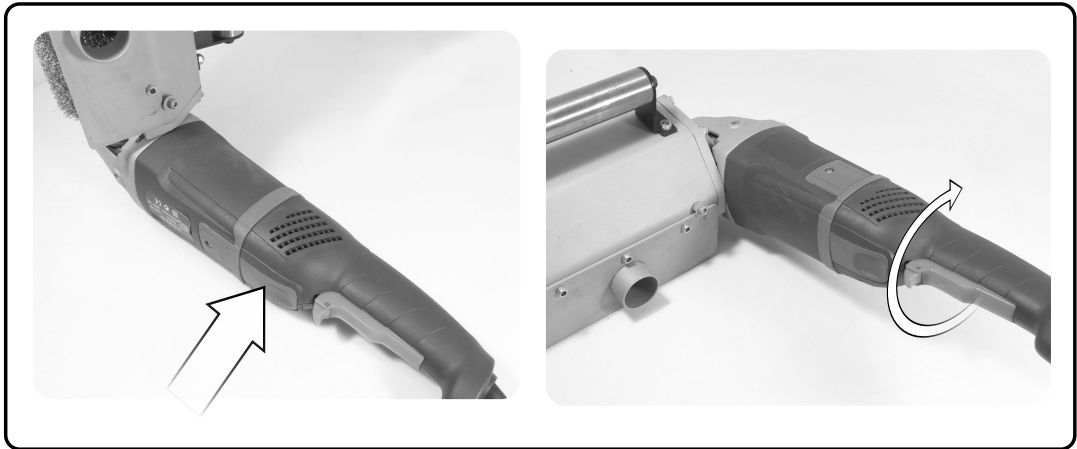
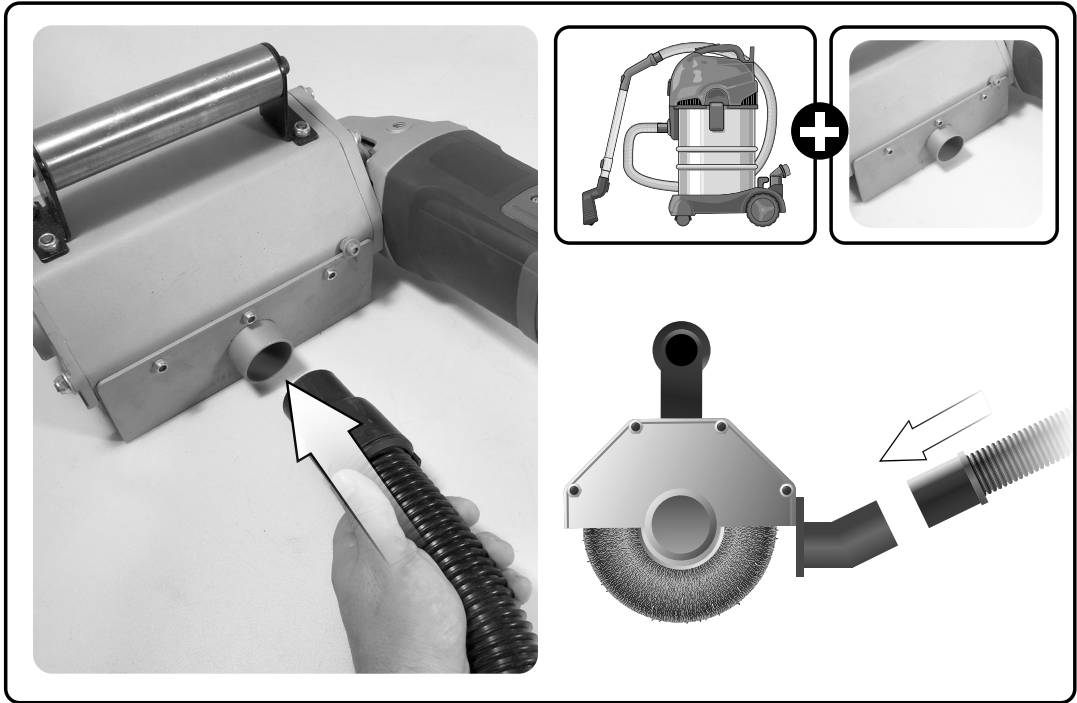


**B**

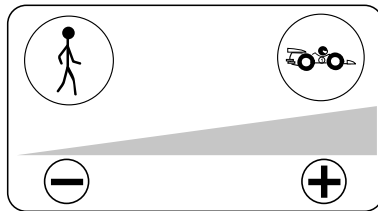


**C**

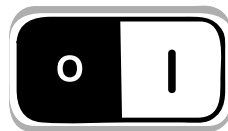
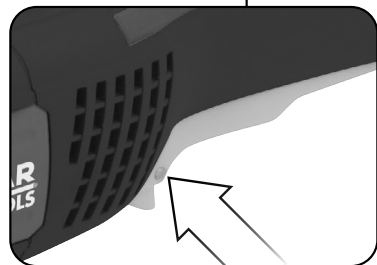
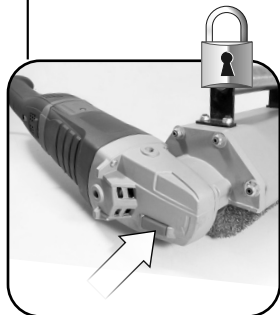
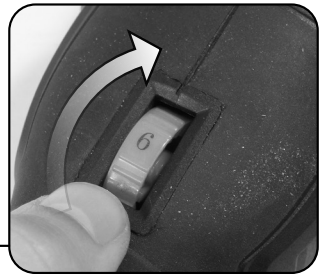


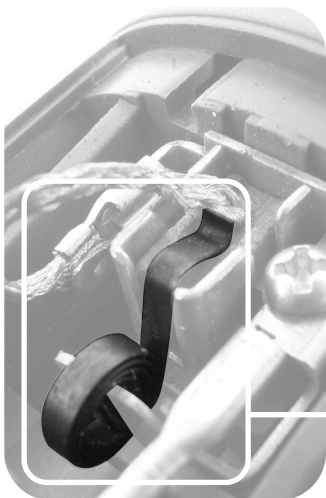
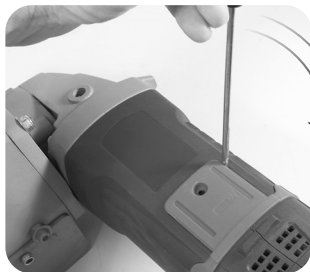


05

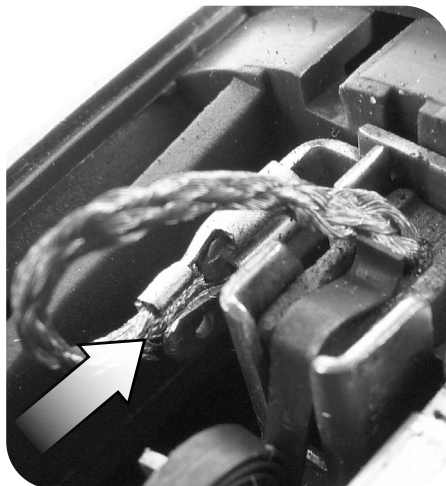
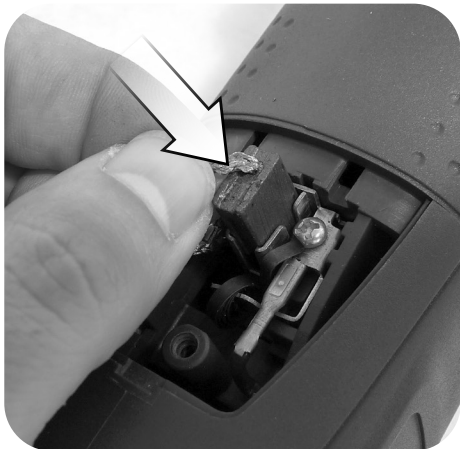
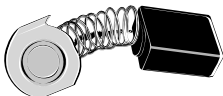
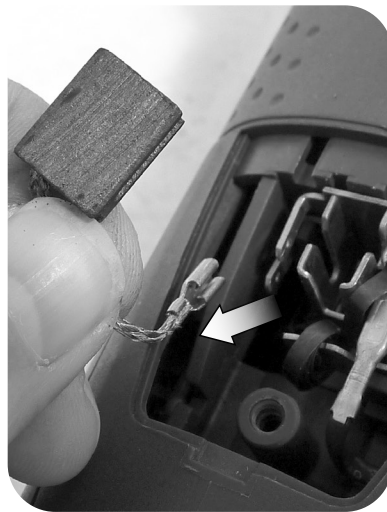
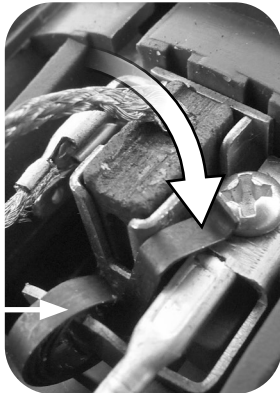


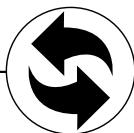
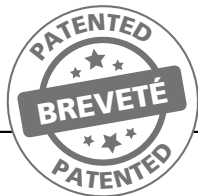
900 - 3200.min<sup>-1</sup>





Retirer la lame du ressort de maintien  
Verwijder de borgveer mes  
Retire la hoja de resorte de retención  
Remove a lâmina de mola de retenção  
Rimuovere la lama molla di ritegno  
Remove the retaining spring blade





110873



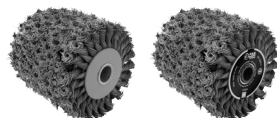
110872 110886



110871 110885



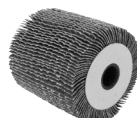
110874



110866 110884



110867



110868







110869





**Précaution ! Stockage au sec et à l'abri de la lumière !**  
**Pozor! Shranjevanje v suhem in zaščiteno pred svetlobo!**  
**¡Precaución! Almacenamiento en seco y protegido de la luz!**  
**Cuidado! Armazenamento em seco e protegido da luz!**  
**Attenzione! Stoccaggio in luogo asciutto e al riparo dalla luce!**  
**Caution! Storage in dry and protected from light!**

	<p>Tension et fréquence assignée:          Nominal frequency and power:          Spannung und Frequenz:          Tensión y frecuencia fijada:          Tensione e frequenza assegnata:          Tensão e frequência fixa:          Angegeven spanning en frequentie:          Ονομαστική τάση και συχνότητα:          Napięcie i częstotliwość przydzielona:          Jännite ja määrätty taajuus:          Angiven spänning och frekvens:          Anført spænding og frekvens:          Tensiune și frecvență de lucru:</p>	<p><b>Заданное напряжение и частота:</b>          Tahsis gerilimi ve frekans:          Stanovené napětí a frekvence:          Stanovené napätie a frekvencia:          ממת ותדר מוקצב.          الفلطيية والذبذبية المبرمجة.          Névleges feszültség és frekvencia:          Napetost in določena frekvenca:  <b>Консумирано напрежение и честота :</b>  <b>Määratud pinge ja dažnis</b>  <b>Nustatyta įtampa ir dažnis</b>  <b>Noteiktais spriegums un frekvence.</b></p>	<p><b>230 V ~ 50 Hz</b></p>
	<p>Puissance assignée:          Nominal power:          Leerlaufdrehzahl:          Potencia fijada:          Potenza assegnata:          Potência assinada:          Onbelast toerental:          Ονομαστική ισχύς :          Prędkość na biegu jałowym:          Teho:          Angiven effekt:          Anført styrke:          Putere de lucru:</p>	<p><b>Заданная мощность:</b>          Tahsis edilen güç:          Stanovený příkon:          Predpísaný výkon:          כוח מוקצב.          القدرة المبرمجة.          Névleges teljesítmény :          Določena jakost:  <b>Консумирана мощност:</b>  <b>Määratud võimsus.</b>  <b>Nustatyta galia</b>  <b>Noteiktā jauda</b></p>	<p><b>1800 W</b></p>
	<p>Vitesse à vide:          No-load speed:          Drehzahl unbelastet:          Velocidad vacía:          Velocità a vuoto:          Velocidade no vácuo:          Leerlaufdrehzahl:          Ταχύτητα στο κενό:          Prędkość bezciążenia:          Tyhjääkäyntinopeus          Tomgångshastighet:          Hastighed i ubelastet tilstand:          Viteza în gol:</p>	<p><b>Скорость вращения на холостом ходу:</b>          Boşalma hızı:          Rychlost naprázdno:          Rýchlost' pri chode naprázdno:          מהירות ריק.          السرعة على الفارغ.          Üres sebesség:          Prosti tek:  <b>Скорост на празни обороти:</b>  <b>Kiirus tühkäigul</b>  <b>Tuščio prietaiso greitis</b>  <b>Tukšgaitas ātrums</b></p>	<p><b>900 - 3200 min<sup>-1</sup></b></p>
	<p>Classe d'isolement : 2          Insulation class : 2          Isolierung klasse : 2          Aislamiento clase :2          Isolamento classe :2          Isolamento classe :2          Isolatie Klasse : 2          Εργαλειο τάξη : 2          Izolacja Klasy :2          Eristysluokka :2          Isolering Klass :2          Isoleringsklasse 2          Clasă izolație :2</p>	<p><b>Класс изоляции 2 :</b>          Yalıtım derecesi :2          Třída izolace :2          Izolačný systém 2          סוג בידוד :2          فئة العزل :2          Szigetelési osztály :2          Razred izolacije :2  <b>Инструмент Клас :2</b>  <b>Isolatsiooniklass 2</b>  <b>Izolācijas rūšis 2</b>  <b>Izolācijas klasse 2</b></p>	<p><b>X</b></p>





	Poids :	<b>Bec :</b>	5,2 kg
	Weight :	Ağırlik :	
	Gewicht :	Hmotnost :	
	Peso :	Hmotnost' :	
	Peso :	משקל	
	Peso :	الوزن.	
	Gewicht :	Súly :	
	Βίρος :	Teža :	
	Masa :	<b>Тегло :</b>	
	Paino :	<b>Raskus</b>	
	Vikt :	<b>Svoris</b>	
	Vægt :	<b>Svars</b>	
	Greutate :		


	Lire les instructions avant usage :	<b>Внимательно прочитайте следующие инструкции :</b>	X
	Read the instructions before use :	Kullanmadan talimatları okuyunuz :	
	Vor Einsatz des Geräts Anweisung lesen :	Pozorně si přečtěte následující pokyny :	
	Léase las instrucciones antes de usar :	Pred použitím si prečítajte pokyny :	
	Leggere le istruzioni prima dell'uso :	זרם חילופי	
	Ler as instruções antes da utilização :	اقرأ التعليمات قبل الاستخدام.	
	Lees voor het gebruik de instructies :	használat előtt olvassuk el az utasítást :	
	Διαβάστε τις οδηγίες χρήσης :	Pred uporabo preberite ustrezna navodila :	
	Zapoznać się instrukcją przed użyciem :	<b>Прочетете указанията за употреба :</b>	
	Lue ohjeet ennen käyttöä :	<b>Enne kasutamist lugege instruksiooni</b>	
	Läs anvisningarna före användning :	<b>Prieš naudojimą perskaityti instrukciją</b>	
læs instruktionerne før brug	<b>izlasīt instrukcijas pirms lietošanas</b>		
Înainte de utilizare, citiți instrucțiunile :			

	Conformité européenne	<b>соответствие европейским стандартам :</b>	X
	Conforms to EC standards :	Avrupa uygunluk :	
	CE-Konformität :	evropská shoda :	
	Cumple con las directivas CE :	európska dohoda :	
	Conforme alle norme CE :	התאמה לתקניסההאירופיים	
	Conforme às normas CE :	مطابق للمواصفات الأوروبية.	
	Voldoet aan de EG-normen :	evropska ustreznost :	
	Σ'υμφωνα με τα προ'τυπα	európai megfeleléség :	
	Zgodność z normami CE :	<b>Съответствие с европейските норми :</b>	
	EU-standardien mukainen :	<b>Euroopa Liidu vastavusmärk</b>	
	EU-standardien mukainen :	<b>Europinių normų atitikima</b>	
Overholder EU standarderne :	<b>Atbilstība Eiropas standartiem</b>		
Conform cu normele europene:			

	Danger :	<b>Опасно :</b>	X
	Danger :	Tehlike :	
	Gefahr :	Nebezpečí :	
	Peligro :	Nebezpečnostvo :	
	Pericolo :	סכנה.	
	Perigo :	خطر.	
	Gevaar :	Veszély :	
	Κιίνος :	Nevamost:	
	Niebezpieczeństwo :	<b>Опасност :</b>	
	Vaara :	<b>Oht</b>	
	Fara :	<b>Pavojus</b>	
	Fare :	<b>Bīstamība</b>	
	Pericol :		





	Diamètre de brosse et largeur : Diameter of wheel and width : Bürsten Sie Durchmesser und Breite: Cepillar diámetro y anchura: Escovar diâmetro e largura: Spennellare diametro e larghezza: Borstel diameter en breedte: Διάμετρο δίσκου : Srednica tarczy i otwór : Leikkuuterän läpimitta ja kalviminen : Skivans diameter och innerdiameter : Skivens ydre og indre diameter : Diametru disc și alezaj :	<b>Диаметр диска и пропила :</b> Disk ve delik çapı : Průměr kotouče a vřtání : Priemer kotúča a vŕtánový priemer : קוטר הדיסקה וקידוד قطر الأسطوانة والتجويف A tárcsa és a furat mérete : Premer diska in izvrtine : <b>Диаметър на резаца :</b> <b>Ketta ja puurimise diameeter :</b> <b>Skersmuo :</b> <b>Diska un caurplūdes atvērums diametrs :</b>	<b>ø 120 mm x 100 mm</b>



- Cet appareil n'est pas prévu pour être utilisé par des personnes (y compris les enfants) dont les capacités physiques, sensorielles ou mentales sont réduites, ou des personnes dénuées d'expérience ou de connaissance, sauf si elles ont pu bénéficier, par l'intermédiaire d'une personne responsable de leur sécurité, d'une surveillance ou d'instructions préalables concernant l'utilisation de l'appareil.

- Il convient de surveiller les enfants pour s'assurer qu'ils ne jouent pas avec l'appareil.

- Dit product is niet bedoeld voor gebruik door personen (inclusief kinderen) met een lichamelijke, zintuiglijke of geestelijke vermogens, of gebrek aan ervaring of kennis, tenzij ze zijn gegeven door door een persoon die verantwoordelijk is voor hun veiligheid, toezicht of instructies over het gebruik van het apparaat.

- Het moet toezicht houden op kinderen om ervoor te zorgen dat zij niet met het apparaat spelen.

- This product is not intended for use by persons (including children) with physical, sensory or mental capabilities, or lack of experience or knowledge, unless they have been given by through a person responsible for their safety, supervision or instruction concerning use of the device.

- It should supervise children to ensure they do not play with the device.

- Este producto no está diseñado para ser utilizado por personas (incluidos niños) con capacidades físicas, sensoriales o mentales, o la falta de experiencia o conocimiento, a menos que hayan sido dadas por través de una persona responsable de su seguridad, supervisión o instrucciones relativas al uso del dispositivo.


- Se debe supervisar a los niños para asegurarse de que no jueguen con el dispositivo.

- Este produto não é destinado ao uso por pessoas (incluindo crianças) com capacidades físicas, sensoriais ou mentais, ou falta de experiência ou conhecimento, a menos que tenham sido dadas por através de uma pessoa responsável pela sua segurança, supervisão ou instruções relativas à utilização do dispositivo.

- Deve vigiar as crianças para garantir que eles não brincam com o dispositivo.






	<p>Soumis à recyclage Subjected to recycling Sujeto a reciclaje Sottoposti a riciclaggio Sujeitos à reciclagem Não deite no lixo : Niet wegwerpen : Μην την πετάτε : Nie wyrzucasz : Älä heittää pois luontoon : Batteriet får inte kastas : Bortkast det ikke: Nu le auncati :</p>	<p>Не выбрасывайте в мусорный ящик Atmayıniz : Nevyhazujte je do bežného odpadu : Neodhadzovat : אין לזרוק סוללות فلا ترمها هلذا في القمامة. ne mečíte! Ne odvříte ga/jih vstran : Не го изхвърляйте : Ärge visake seda minema : Nemétykíte : Nemest : Podvrgnuto recikliranju</p>	X
---	---	--	---


**Recyclage des déchets :**


Les outils, accessoires et leur emballages doivent suivre une voie de recyclage adaptée. Conformément aux directives Européenne 2012/19/UE et 2006/66/CE, les composants d'un produit doivent être séparés, collectés, recyclés ou éliminés en conformité avec les réglementations environnementales en vigueur. Les appareils, batteries, piles, huiles, emballages devront être déposés dans les systèmes d'élimination des déchets spéciaux tels que déchetteries. Renseignez-vous auprès de votre commune pour connaître l'organisme le plus proche à même de retraiter ou de collecter ces déchets.


	<p>Recyclable, soumis au tri sélectif Recyclable, subject to recycling Recyclingfähige, unterliegen Recycling Reciclables, sujetos a reciclaje Riciclabili, soggetti a riciclaggio Recicláveis, sujeito à reciclagem Recycleerbare, onderworpen aan recycling Ανακυκλώσιμες συσκευασίες που υπόκεινται σε κύκλωση Opakowanie nadaje się do recyklingu podlegają recyklingu Kierrätettävien pakkausten kohteena kierrätys Återvinningsbara förpackningar omfattas återvinning <b>Рециклираци се опаковки подлежат на рециклиране</b> Genanvendelig underlagt genbrug</p>	<p>Reciclabile sub rezerva reciclare <b>Повторно упаковка подлежит вторичной переработке</b> Gerü dönüşüm Gerü dönüştürülebilir ambalaj konusu Recyklovateľné podléhajúci recyklácii Recyklovateľné podliehajúce recyklácii החמל והחמל הזיראה אשונ ريودتلا هاعال غرضيت ريودتلا هاعال هاباؤلا فجيل غتلاو هوب غتلا Újrahasznosítható csomagolás alá újrahasznosítás Reciklirati predmet recikliranja Pakendite suhtes ringlussevõtu Pärsträdajams iepakojuoms otrreizējai pārstrādei Perdirbamų taikomos perdirbimo <b>Može se reciklirati, podložno selektivnom sortiranju</b></p>	X
---	---	---	---






	<p>Porter des lunettes de sécurité : Wear protective eyewear : Schutzbrille tragen : Llevar puestas gafas protectoras : Portare de gli occhiali di sicurezza : Utilizar óculos de segurança : Draag een veiligheidsbril : Φορέστε Προστατευτικά γυαλιά : Zakładać okulary ochronne : Käytä suojalaseja : Använd skyddsglasögon : Der skal benyttes sikkerhedsbriller : Purtati ochelari de protecție :</p>	<p><b>Наденьте защитные очки :</b> Güvenlik gözlükleri takın : Používejte bezpečnostní brýle : Noste ochranné okuliare : תחבוטב יפקשמ ביכרהל אן חמל נזפארט וקאי. Viseljen védőszemveget : Nositi zaštitna očala : <b>Да се използват защитни очила :</b> Kandke kaitseprille Nešioti apsauginius akinius Valkät aizsargbrilles Nositi zaštitne naočale:</p>	X
---	--	---	---


	<p>Porter un masque anti-poussière : Wear a dust mask : Staubschutzmaske tragen : Llevar puesta una careta de protección contra el polvo : Indossare una mascherina anti-polvere : Utilizar uma máscara anti-poeira : Draag een stofmasker : χρήση προστατευτική μάσκα : Zakładać maskę przeciwpyłową Käytä pölysuojust : Bär mask mot damm : Der skal benyttes beskyttelsesmaske mod støv: Purtati mască anti-praf :</p>	<p><b>Наденьте респиратор :</b> Toza karşi maske takın : Používejte masku proti prachu : Noste ochrannú masku proti prachu : קבא דגן הכסמ שובחל אן ליס קזא ע מצראס ללגבאר. Viseljen porvédő maszkot Nositi zaštitno masko proti prahu: <b>Да се използва защитна маска :</b> Kandke tolmumaski. Dëvëti respiratoriq Valkät aizsarg masku pret putekļiem Nositi masku za zaštitu od prašine:</p>	X
---	---	---	---


	<p>Porter une protection auditive : Wear hearing protective equipment: Gehörschutz tragen: Llevar puesta una protección auditiva: Portare una protezone uditiva: Utilizar uma protecção auditiva: Draag gehoorbeschermers: Φορέστε Προστατευτικά ακουστικά Zakładać słuchawki ochronne Käytä kuulusoajimia: Bär hörselskydd: Der skal benyttes høreværn: Purtati căști de protecție auz:</p>	<p><b>наденьте средства звуковой защиты:</b> İşitsel koruma aleti takın: Používejte ochranu sluchu: Noste ochranné slúchadlá: יש ל הרכיב הגנת שמיעה ליס חזדה חרזס אלחסיג Viseljen fülvédő Nositi zašito ušes: <b>Да се използва слухови защитни средства:</b> Kandke kõrvakaitset Nešioti apsauga nuo triukšmo Valkät dzirdes aizsarglīdzekli Nositi štitnike protiv buke:</p>	X
---	--	--	---

	<p>Porter des gants : Use rubber gloves : Schutzhandschuhe tragen : Llevar guantes de protección : Indossare i guanti di protezione : Utilizar luvas de protecção : Draag veiligheidshandschoenen : χρήση προστατευτικών γαντιών : Używać rękawic ochronnych : Käytä suojakäsineitä : Använd skyddshandskar : Der skal benyttes handsker : Purtati mănuși :</p>	<p><b>Наденьте перчатки :</b> Eldiven takın : Noste rukavice : Noste rukavice : תופכ שובלל אן ליס קפארט. Viseljen kesztyű t Nositi rokavice: <b>а се използват предпазни ръкавици :</b> Kandke kindaid Müvëti pirštines Valkät cimdus Nositi zaštitne rukavice:</p>	X
---	---	---	---





 <b>L<sub>pA</sub></b>	Niveau de pression acoustique : Acoustic pressure level : Schalldruckpegel : Nivel de presión acústica : Livello di pressione acústica : Nivel de pressão acústica : Niveau akoestische druk : Στάθμη Θορύβου : Poziom mocy akustycznej : Käytä kuulosuojaimia : Ljudtrycksnivå : Lydtryk : Nivel presiune acustică :	<b>Уровень акустического давления. :</b> Akustik basınç seviyesi : Hladina akustického tlaku : Hladina akustického tlaku : רמת לחץ אקוסטי : مستوى الضغط السمعي : A hangnyomás szintje : Nivo akustičnega pritiska : <b>Равнище на акустично налягане :</b> <b>Helirõhu nivoo</b> <b>Akustinio spaudimo lygis</b> <b>Akustiskā spiediena līmenis</b>	<b>102 dB (A)</b>
--	---	--	-------------------

 <b>L<sub>wA</sub></b>	Niveau de puissance acoustique : Acoustic power level : Schalleistungspegel : Nivel de potencia acústica : Livello di potenza acústica : Nivel de potência acústica : Niveau akoestisch vermogen : Στάθμη Ονομαστικής Θορύβου : Poziom mocy akustycznej : Käytä suojalaseja : Ljudstyrkenivå : Lydstyrke : Nivel putere acustică :	<b>уровень мощности звука :</b> Akustik basınç seviyesi : Hladina zvukového výkonu : <b>Hladina zvukového výkonu:</b> רמת כוח אקוסטי : مستوى الضجيج : a hangnyomás szintje : <b>Nivo akustične jakosti :</b> <b>Равнище на вибрации :</b> <b>Helivõimsuse nivoo</b> <b>Triukšmo lygis</b> <b>Akustiskās jaudas līmenis</b>	<b>114 dB (A)</b>
--	--	---	-------------------

NIVEAU SONORE D'EMISSION: A VIDE


Pression acoustique LpA poste opérateur 102 dB  
 Incertitude 3

Puissance acoustique LWA 114 dB  
 Incertitude 3

Valeurs déterminées suivant le code d'essai de l'annexe B de la norme EN 61029-1 avec emploi des normes de base ISO 11201 et ISO 3744.

Les niveaux de pression acoustique obtenus in situ dépendent:

- Des niveaux réels de la machine considérées, en prenant en compte les incertitudes déclarées;
- Du local et de l'installation de la machine. Préférez une pièce dont l'acoustique est plus feutrée. Evitez les pièces vide à grande résonance. Placez vous auprès d'une fenêtre le cas échéant.
- Des outils montés, des pièces travaillées, des réglages choisis,...

 <b>L<sub>v</sub></b>	Niveau de vibration : Hand/arm vibration level : Vibrationspegel Hand/Arm : Nivel de vibración mano/brazo : Livello di vibrazione mano/braccio : Nivel de vibraçãõ mão/braço : Trillingsniveau hand/arm : Στάθμη κρατσοσπινδόν : <b>Poziom wibracji rżka/ramiż :</b> Tärinätaso: Vibrationsnivå hand/arm : Vibrationsniveau : Nivel vibrații :	<b>Уровень вибрации :</b> Titreşim seviyesi : Úroveň vibrací : <b>Hladina vibrácií :</b> רמת תנודות : مستوى الارتجاج : Vibrációs szint : <b>Nivo vibracij :</b> <b>Равнище :</b> <b>Vibrācijas līmenis.</b> <b>Vibrācijas lygis</b> <b>Vibratsiooni nivo</b>	<b>3,2 m / s<sup>2</sup></b>
---	--	---	------------------------------

VIBRATIONS:

Total des valeurs de vibration ( somme vectorielle des trois directions ) déterminée selon EN 60745:

a 3,2 m/s<sup>2</sup>  
 Incertitude K 1,5 m/s<sup>2</sup>

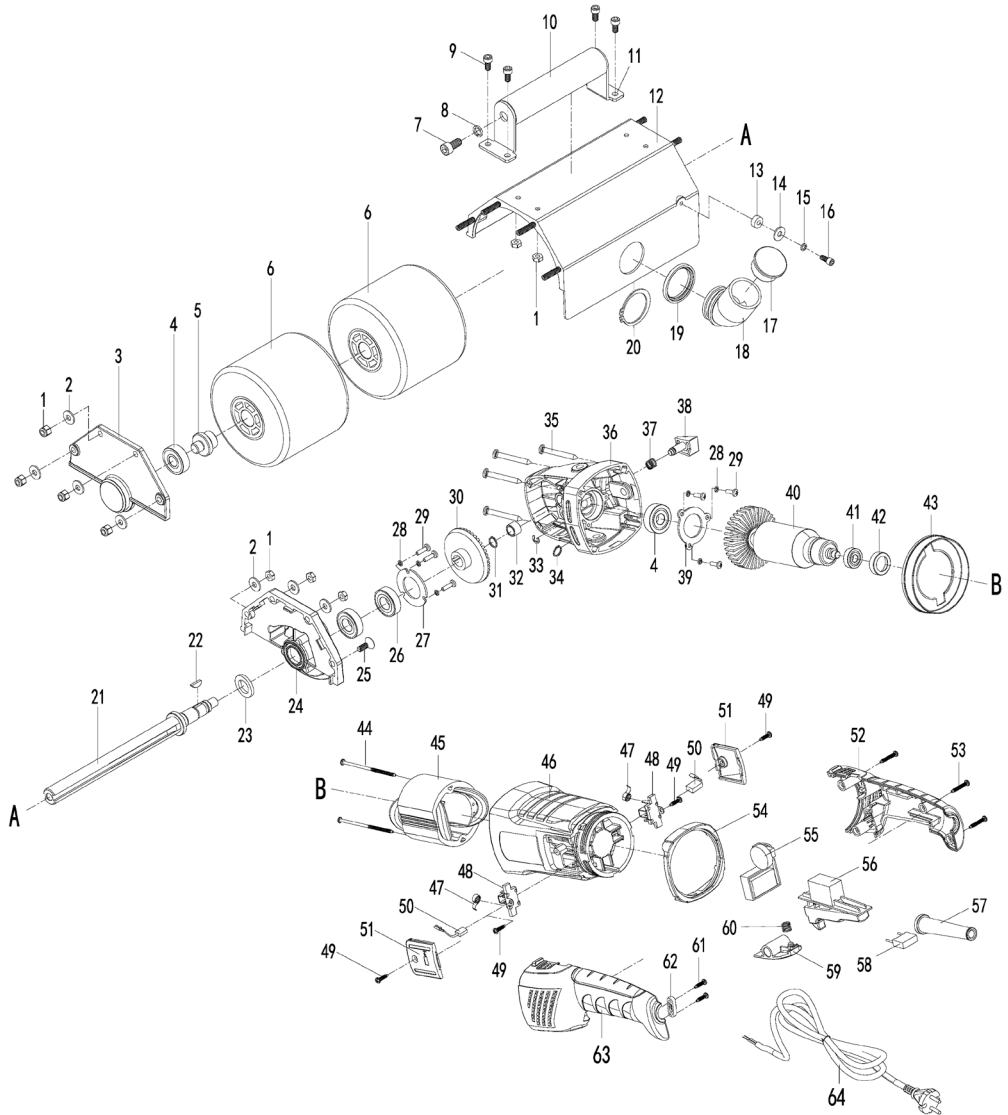
L'amplitude d'oscillation peut être utilisée comme valeur de comparaison d'outils électroportatifs.

Attention: Si l'outil électroportatif est utilisé pour d'autres applications, avec d'autres outils de travail, l'amplitude d'oscillation peut être différente.





REX 200





115015-Sticker-A-01-Normes.indd 1

27/02/2020 11:38



115015-Sticker-A-01-Normes.indd 2

27/02/2020 11:38



115015-Sticker-A-02-200mm.indd 1

27/02/2020 11:40



DECLARATION DE CONFORMITE  
VERKLARING VAN OVEREENSTEMMING  
DECLARACION DE CONFORMIDAD  
DICHIARAZIONE DI CONFORMITA  
KONFORMITÄSERKLÄRUNG  
DECLARATION CONFORMITY  
DECLARAÇÃO DE CONFORMIDADE  
DEKLARACJA ZGODNOSCI Z NORMAMI  
OM OVERENSSTAMMELE  
VAATIMUSTENMUKAISUUSVAKUUTUS  
OVERENSSTEMMELSEERKLÆRING  
ΔΗΛΩΣΗ ΣΥΜΜΟΡΦΩΣΗΣ  
DECLARAȚIE DE CONFORMITATE

VYHLÁSENIE ZHODY  
Декларация соответствия  
הצהרת תואמת  
Uygunluk beyanı  
التصريح بالامتثال  
PROHLÁŠENÍ SHODY  
EGYZŐSÉGI NYILATKOZAT  
Декларация за съответствие с нормите  
IZJAVA O SKLADNOSTI  
DEKLARACIJA  
ATTIKTIES DEKLARACIJA  
KIINNITUS  
IZJAVA O SUKLADNOSTI

**Le soussigné,**  
Ondergetekende,  
Der Unterzeichner,  
O abaixo assinado,  
Undertecknad,  
Долуподписаният  
Undertegnede  
Subsemnatul,  
Ο κάτωθι υπογεγραμμένος,  
Imzalayan,  
Niže potpisaný,  
Toliau pasirašęs  
El suscrito,

**Déclare par la présente que,**  
Verklaart hiermede dat,  
Erklärt hiermit daß,  
Declara pela presente que,  
Förklarar härmed att  
Заявява с настоящото  
erklærer hermed, at  
Declar prin prezenta că,  
Με το παρόν δηλώνει ότι,  
Mevcut belgeyle beyan ediliyor ki,  
tímo prohlasuje, že,  
Pareiškia, kad,  
Declara por la presente, que,

Personne autorisée à constituer  
le dossier technique :  
Christophe HUREL



FAR GROUP EUROPE  
192, Avenue Yves Farge  
37700 St. Pierre-des-Corps  
FRANCE

Il sottoscritto,  
The undersigned,  
Ninje potpisany  
Allekirjoittanut,  
Oyttogegramm9enoz  
Nižšie potpísany  
החתום מטה  
الموقوع أدناه  
Alulírott,  
Podpisani,  
Apakšā parakstījies  
allakirjutanu  
Dolje potpisani,

Dichiare che,  
Declares that,  
OÖwiadcza niniejszym, że  
Ilmoitetaan täten että,  
Dhl9vnei me thn Paro9ysa  
tymto vyhlasuje, že  
מצהיר בזה כי  
يصرح استنادا على ذلك  
kijelentem, hogy a készülék Izjavlja da,  
Pareiškia, kad,  
Ar šo apliecina, ka,  
Kinnitab, et  
Izjavljuje u ovom dokumentu da je

**Rénovateur extérieur / Exterior renovator / Schleif- und Renoviergerät / Fuera renovador / Restauratore di fuori / Fora renovador / Buiten renovator /**  
έξω από ανακαινιστής / **Poza renovatora / Ulkopuoletta remontoijille / Utanför renovator / Извън обновен / Udenfor renovator / In afara renovator /**

**Bue pcamasrapoma / Yenileyen dışında / Mimo renovátor / מומו קניצופיש נוחמ / كبحم مبراع / Kivül renovator / Zunanj Obnovilac / Öues renovator /**  
**ārpus atjaunotājs / Už Restorer / Vanjski renovator**

## code

FARTOOLS / 115015 / REX 200 / S1P-HJ2213H

**Est conforme et satisfait aux directives et normes CE,**  
In overeenstemming is met en Voldoet aan EG richtlijnen,  
Den folgenden EU-Bestimmungen entspricht,  
Respeita e está em conformidade com as normas CE,  
Överensstämmer med och uppfyller EG-standarder,  
Съответства и отговаря европейските норми  
Er i överensstemmelse med og overholder EU standarderne  
Este conform și satisfăce normele CE  
полностью соответствует и удовлетворяет требованиям стандартов EC  
CE şartlara uygundur,  
odpovídá normám ES.  
Atitinka ir atitinka EB direktyvas ir standartus,  
Cumple con la directivas de la CE,

È conforme alle direttive CEE,  
Complies with the EEC directives and standards,  
Odpowiada normom UE,  
Täyttää EU-vaatimukset,  
Συμμορφώνεται και πληροί τις οδηγίες και τα πρότυπα CE,  
zodpovedá normám ES.  
מתאים ועונה לתקני CE  
بأن الجهاز يطابق و يلبي معايير مجموعة الدول الأوروبية  
kielégíti a CE szabványok előírásait.  
Je v skladu z in izpolnjuje norme Evropske skupnosti.  
Atbilst un atbilst EK direktīvas un standartus.  
Vastab ja vastab EÜ direktiividele ja standarditele,  
Sukladan i ispunjava direktive i standarde CE,

2006/42/EC 2014/30/EU 2011/65/EU 2015/863/EU

EN62841-2-4:2014+AC:2015  
EN62841-1:2015+AC:2015+A11:2022

EN IEC 55014-1:2021  
EN IEC 55014-2:2021  
EN IEC 61000-3-2:2019+A2:2024  
EN61000-3-3:2013+A1:2019+A2:2021

Christophe HUREL,  
Président Directeur Général  
22/11/2024  
Fait à St. Pierre-des-Corps

## GARANTIE - WARRANTY



### FR. GARANTIE

Cet outil est garanti contractuellement contre tout vice de construction et de matière, à compter de la date de vente à l'utilisateur et sur simple présentation du ticket de caisse. La garantie consiste à remplacer les parties défectueuses. Cette garantie n'est pas applicable en cas d'exploitation non conforme aux normes de l'appareil, ni en cas de dommages causés par des interventions non autorisées ou par négligence de la part de l'acheteur. La garantie ne s'applique pas sur les dommages causés par une défaillance de l'outil.

### DE. GARANTIE

Die Garantiezeit für dieses Gerät in Bezug auf Konstruktions- und Materialfehler beträgt 1. Vertrag bei Vorlage des Kassensbons. Die Garantieleistung besteht im Ersatz schadhafter Teile. Die Garantie erlischt bei einem Einsatz des Geräts, der nicht normentsprechend ist, bei Schäden, die auf unsachgemäße Eingriffe zurückzuführen sind bzw. bei Nachlässigkeit seitens des Käufers. Die Garantie erstreckt sich nicht auf Schäden, die auf Fehlfunktionen des Geräts zurückzuführen sind.

### IT. GARANZIA

Quest' attrezzo è garantito per contratto contro qualsiasi difetto di costruzione e di materia, a partire dalla data di vendita all' utente e su semplice presentazione dello scontrino. La garanzia consiste nel sostituire le parti difettose. Questa garanzia non è applicabile in caso di sfruttamento non conforme alle norme dell' apparecchio, né in caso di danni causati da interventi non autorizzati o da negligenza da parte dell' acquirente. La garanzia non si applica ai danni causati da un' avaria dell' attrezzo.

### NL. GARANTIE

This tool is guaranteed, in writing, against any defect in manufacture or parts from the date of sale, upon simple presentation of the sales slip. The guarantee is limited to the replacement of faulty parts. This guarantee is not applicable in the event of usage which is not conform with the intended usage of the apparatus, nor in the event of damage caused by unauthorised servicing or negligence on behalf of the purchaser. This guarantee does not apply to any damage caused by the failure of this tool.

### ES. GARANTIA

Esta herramienta se garantiza contractualmente contra todo defecto de construcción y materia, a partir de la fecha de venta a l' usuario y sobre simple presentación del recibo de caja. La garantía consiste en sustituir a las partes defectuosas. Esta garantía no es aplicable en caso de explotación no conforme a las normas del aparato, ni en caso de danos causados por intervenciones no autorizadas o por negligencia por parte del comprador. La garantía no se aplica sobre los danos causados por un fallo del herramienta.

### NL. GARANTIE

Dit gereedschap heeft een garantie tegen constructiefouten en materiaaldefecten, die geldig is vanaf de aankoopdatum door de gebruiker, op vertoning van de kassabon. De garantie betreft de vervanging van de defecte onderdelen. Deze garantie is niet van toepassing indien het apparaat niet volgens de normen gebruikt is, noch in geval van schade veroorzaakt door oneigenlijk gebruik of nalatigheid van de koper. De garantie is niet van toepassing op schade voortvloeiend uit een defect van het gereedschap.

### PT. GARANTIA

Esta ferramenta tem uma garantia contratual contra qualquer defeito de construção e de material, a partir da data de venda ao utilizador e sobre simples apresentação do talão da caixa. A garantia consiste em substituir as partes defeituosas. Esta garantia não é aplicável no caso de exploração não conforme as normas do aparelho, nem em caso de danos causados pelas intervenções não autorizadas ou por negligência da parte do comprador. A garantia não se aplica para os danos causados por uma falha da ferramenta.

### EL. ΕΓΓΥΗΣΗ

ΑΥΤΟ ΤΟ ΕΡΓΑΛΕΙΟ ΕΙΝΑΙ ΣΥΜΒΑΤΙΚΑ ΕΓΓΥΗΜΕΝΟ ΓΙΑ ΟΠΟΙΟΔΗΠΟΤΕ ΚΑΤΑΣΚΕΥΑΣΤΙΚΟ ΚΑΙ ΥΛΙΚΟ ΕΛΑΤΤΩΜΑ, ΑΠΟ ΤΗΝ ΗΜΕΡΟΜΗΝΙΑ ΠΩΛΗΣΗΣ ΣΤΟΝ ΧΡΗΣΤΗ ΚΑΙ ΜΕ ΤΗΝ ΕΠΙΔΕΙΞΗ ΤΗΣ ΑΠΟΔΕΙΞΗΣ ΠΩΛΗΣΗΣ. Η ΕΓΓΥΗΣΗ ΣΥΝΙΣΤΑΤΑΙ ΣΤΗΝ ΑΝΤΙΚΑΤΑΣΤΑΣΗ ΤΩΝ ΕΛΑΤΤΩΜΑΤΙΚΩΝ ΕΞΑΡΤΗΜΑΤΩΝ. ΑΥΤΗ Η ΕΓΓΥΗΣΗ ΔΕΝ ΙΣΧΥΕΙ ΣΕ ΠΕΡΙΠΤΩΣΗ ΛΕΙΤΟΥΡΓΙΑΣ ΠΟΥ ΔΕΝ ΣΥΜΜΟΡΦΩΝΕΤΑΙ ΜΕ ΤΑ ΠΡΟΤΥΠΑ ΤΗΣ ΣΥΣΚΕΥΗΣ, ΟΥΤΕ ΣΕ ΠΕΡΙΠΤΩΣΗ ΖΗΜΙΑΣ ΠΟΥ ΠΡΟΚΑΛΕΙΤΑΙ ΑΠΟ ΜΗ ΕΥΣΥΣΙΟΔΟΤΗΜΕΝΕΣ ΕΠΙΜΕΒΑΣΕΙΣ Ή ΑΜΕΛΕΙΑ ΕΚ ΜΕΡΟΥΣ ΤΟΥ ΑΓΟΡΑΣΤΗ. Η ΕΓΓΥΗΣΗ ΔΕΝ ΙΣΧΥΕΙ ΓΙΑ ΖΗΜΙΕΣ ΠΟΥ ΠΡΟΚΑΛΟΥΝΤΑΙ ΑΠΟ ΑΣΤΟΧΙΑ ΕΡΓΑΛΕΙΟΥ.

### PL. GWARANCJA

Narz dzie jest objte gwarancja w wszelkie wady konstrukcyjne i materiałowe, licząc od daty

sprzedaży u użytkownikowi i po okazaniu paragonu kasowego. Gwarancja obejmuje wymianę cz.ści wybrakowanych. Gwarancja nie znajduje zastosowania w przypadku użytkowania niezgodnego z normami urzadzzenia, ani w przypadku szkód spowodowanych działaniami niedozwolonymi lub zaniedbaniami ze strony nabywcy. Gwarancja nie obejmuje szkód powstających z powodu upadku urzadzzenia.

### SV. GARANTI

Detta verktyg har en avtalsenlig garanti mot konstruktions och materialfel, från och med tidpunkten för användarens inköp och genom uppvisning av kassakvittot. Garantin består i att ersätta de bristfälliga delarna. Denna garanti gäller inte om användningen inte motsvarar apparatens standarder, inte heller vid skador som orsakas av ej tillåtna ingrepp eller på grund av Koparens vårdslöshet. Garantin gäller inte forskador som orsakats av att verktyget fungerat bristfälligt.

### FI. TAKUU

Tämän laitteen takuu on voimassa sopimuksen mukaisesti kattaen kaikki rakenne- ja materiaaliiviat lukien ostopaivasta kassakuitilla vastaan. Takuu sisältää viallisten osien korvaamisen. Takuu ei korvaa ohjeiden vastaista käyttöä eikä valtuuttamattomien henkilöiden käsittelystä tai ostajan huolimattomuudesta aiheutuneita vahinkoja. Takuu ei vastaa myöskään toimintahäiriöistä aiheutuneita vahinkoja.

### BU. Гаранция

Този инструмент е под договорна гаранция срещу всякакъв дефект в изработката и използваните материали, считано от датата на продажба на потребителя и само срещу представяне на касовата бележка. Гаранционното обслужване се състои в замяна на дефектните части. Настоящата гаранция не е валидна когато aparatът се използва по начин, несъответстващ на стандарта за работа с него, както и в случай на щети, нанесени от неоторизирани лица, или вследствие на проявена небрежност от страна потребителя.

Гаранцията не покрива щети, произтекли вследствие на техническа неизправност на апарата.

### DA. GARANTI

Dette værktøj er dækket af en garantikontrakt for konstruktions- og materialefej, som gælder fra købsdatoen ved visning af kassebonen. Garantien består i at udskifte de defekte dele. Garantien dækker ikke fejl opstået som følge af anvendelse, som ikke overholder standarderne for apparatet, eller

## SERVICE APRÈS VENTE - AFTER SALE SERVICE

FARGROUP EUROPE - 192, Avenue Yves Farge - 37700 St. Pierre-des-Corps - FRANCE

fargroup@fargroup.net

## GARANTIE - WARRANTY



skader opstået ved ikke autoriserede indgreb eller sløsethed fra brugerens side. Garantien dækker ikke skader opstået, fordi værktøjet har svigtet.

### RO. GARANTIE

Acest aparat este garantat din punct de vedere contractual împotriva tuturor viciilor de construcție și de material, începând de la data vânzării lui către utilizator și la simpla prezentare a bônului de casă. Garanția constă în înlocuirea componentelor defecte. Această garanție nu se aplică în cazul exploatării în alt mod decât cel recomandat de normele aparatului și nici în caz de stricăciuni provocate de intervenții neautorizate sau prin neglijența cumpărătorului. Garanția nu se aplică asupra paglorbelor cauzate de o defectare a aparatului.

### RU. ГАРАНТИЯ

Данное изделие обладает имеющей силой гарантии, все возможные дефекты изготовления и материала. Гарантия вступает в силу с даты продажи изделия пользователю, для этого достаточно сохранить и предъявить полученный в кассе чек. Гарантия обязывает изготовителя заменить дефектные части изделия. В случае не соответствующего нормам использования изделия, несанкционированного демонтажа или ремонта или небрежного обращения действие гарантии прекращается. Гарантия не покрывает ущерба, возникшего в результате сбоя в работе изделия.

### TU. GARANTI

Bu arac, satis tarihinden itibaren, kullanicinin sadesce vezne alindisini sunmasiyla tum uretim ve malzeme hatasina karsi garantilidir. Garanti eksik olan kisimlari degistirmek icindir. Bu garanti aracın sartlarina uygun olmayan isleme durumunda, izin verilmeyen kullanimlardan kaynaklanan hasarlarda veya alincinin istegi durumunda uygulanmaz. Garanti malzemenin bir eksikliginden meydana gelen bir zararda uygulanmaz.

### CS. ZÁRUKA

Pro tento nástroj platí smluvní záruka na všechny výrobní a materiállové vady od data prodeje uživateli a na základě předložení pokladního bloku. Záruka spočívá ve výměně vadných částí. Tato záruka neplatí v případě použítu přístroje, které

neodpovídá normám, ani v případě škod způsobených nepovolenými zásahy nebo nedbalostí ze strany kupujícího. Záruka se nevztahuje na škody způsobené závadou nástroje.

### SK. ZÁRUKA

Pre tento nástroj platí zmluvná záruka na všetky výrobné a materiállové chyby od dátumu predaja užívateľovi a na základe predloženia pokladničného bloku. Záruka spočíva vo výmene chybných častí. Táto záruka neplatí v prípade použitia prístroja, ktoré nezodpovedá normám, ani v prípade škod spôsobených nepovolenými zásahmi alebo nedbalosťou zo strany kupujúceho. Záruka sa nevzťahuje na škody spôsobené poruchou nástroja

### AR. الضمان

علي جرد توريد بطاقة الشراء يت عمل في تاريخ البيع الذي الى المبرمت عمل وبناء في التصدي عوفى المواد، إعتباراً من الع دة حضوره تغاوديا عن أي عيب في حالة تعرضه لتالفات إن هذه غير المطابق لمعايير الجهان، ولا أبداً للتطبيق في حالة الاستخدام الأجزاء العاطلة لا يكون هذا الضمان الذاتج عن حال الضمان فاي ستبدال المشتري لا يتطبق الضمان على الضرر غير جرحصة أو حالة الأفعال عن قبل ناتجة عن عجزات تدخل

### HU. GARANCIA

Erre a szerszámra szerződéses garanciát vállalunk bármilyen gyártási és anyaghiba felmerülése esetére a fogyasztó részére történő eladás napjától számítva, a penztári blokk egyszerű felmutatása ellenében. A garancia a hibás alkatrészek cseréjére terjed ki. Ez a garancia nem érvényes, ha a készülék nem rendeltetésszerűen használtak, sem illetéktelen beavatkozások vagy a vásárló hanyagsága okozta károk esetén. A garancia nem fedezi azokat a károkat, melyeket a szerszám hibás működése okozott.

### SI. GARANCIJA

To prodje je z garancijsko pogodbo zasciteno proti vsem napakam v izdelavi in v sestavnem materialu od datuma prodaje naprej in ta velja ob predložitvi blagajniškega računa. Garancija velja za zamenjavo delov z napako. Ta garancija ne velja za uporabo orodja, ki ni v skladu z normami, predpisanimi za omenjeno prodje in za primere okvar, ki nastanejo zaradi nedovoljenih posegov na orodju ali zaradi malomarnega rokovanja kupca. Garancija ne velja za škodo, ki jo lahko povzroci okvara orodja.

### ET. GARANTII

See toorist kuulub lepingu järgi garantiiremonti arvestades alates müumise päevast ja kassatseki alusel kasutajale koigi konstruktsiooni-

ja materjalivigade puhul. Garantii seisneb defektsete osade välja vahetamises. See garantii ei kehti aparaadi normide ebatavalise eiramise puhul ega ostja poolt keelatud viisil kasutamises või hooletussejätmisest tulenevate kahjude korral. Garantii ei kehti seadme defektidest põhjustatud kahjude puhul

### LV. GARANTĪJA

Sis prietaisas yra uztiķirinamas kaip itin geros kokybes, nuo jo pardavimo datos iki jo panaudojimo, ir jam yra suteikiamas garantinis talonas. Garantijos metu galima pakeisti atsiradusius trūpliaikius gedimus. Ši garantija netaikoma esant netinkamam naudojimui ar nesilaikant reikiam ši aparaato vartojimo instrukcijų, tai pat paciam pirkeiui ji sugadinus. Garantija taip pat netaikoma, prietaisa naudojant ne pagal paskirti ir jį apgadinus

### LT. GARANTUJA

Sim darbarikam ir liguma noteikta garancija visiem defektiem. Kas saistas ar konstrukciju un materialu, sakot ar pardosanas datumu, kad masinu, pardod lietotajam un vienkarši uzradot kases ceku. Garancija iekļauj bojāto daļu nomaiņu. Šī garancija nav derīga, ja aparats nav lietots saskaņā ar drošības noteikumiem, ne gādājums ja bojājumi radusies nesankcionētas ielejaušanas gadījumā vai arī pierceja nolaidības dēļ. Garancija nav derīga, ja bojājumi radusies darbarika defekta dēļ

### HR. JAMSTVO

Ovaj alat ima ugovorno jamstvo u slucaju bilo kakvih nedostataka u konstrukciji i materijalu, od datuma prodaje korisniku uz jednostavno predocenje racuna. Jamstvo se sastoji u zamjeni neispravnih dijelova. Ovo se jamstvo ne primjenjuje u slucaju uporabe i eksploatacije koja nije sukladna standardima uređaja, niti u slucaju stete uzrokovane neovlastenim intervencijama ili nemarom kupca. Jamstvo se ne primjenjuje na štetu uzrokovanu nekim nedostatom alata.

## SERVICE APRÈS VENTE - AFTER SALE SERVICE

FARGROUP EUROPE - 192, Avenue Yves Farge - 37700 St. Pierre-des-Corps - FRANCE

fargroup@fargroup.net



## FAR GROUP EUROPE

Une société du groupe **SIGMA**

192, Avenue Yves Farge  
37700 St. Pierre-des-Corps  
FRANCE

[fartools.com](http://fartools.com)

