

QUICK START

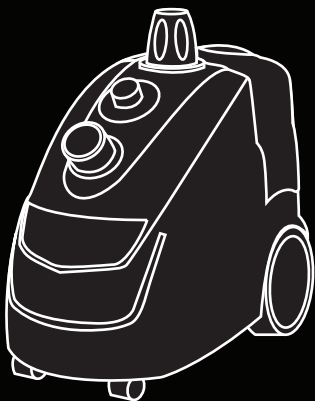

SteamOne

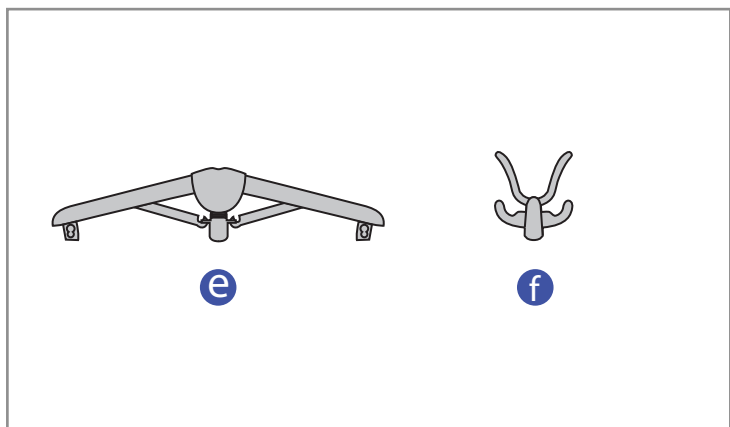
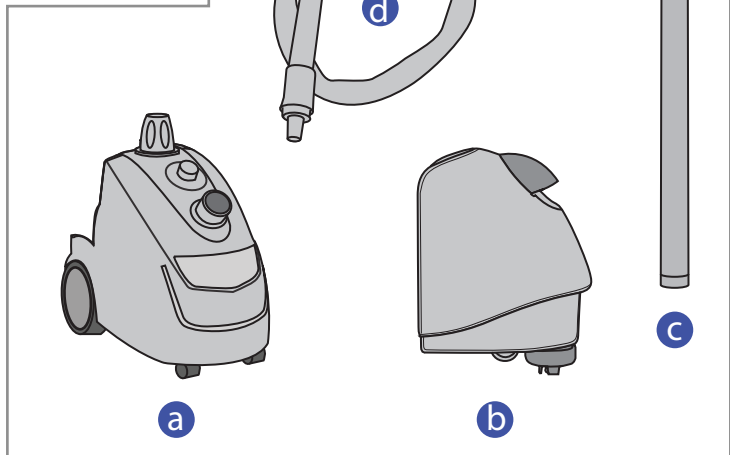

1

a + C

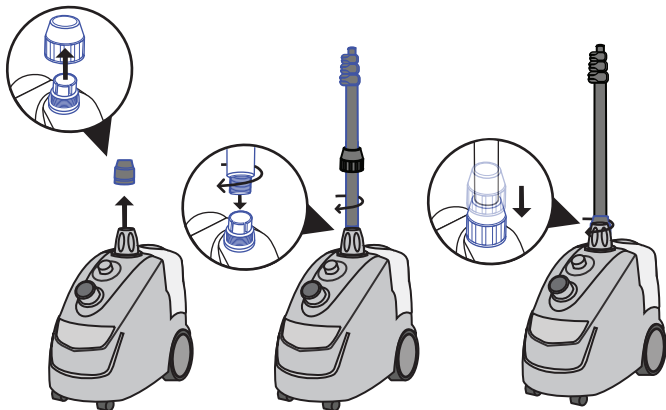

1

2

3

2

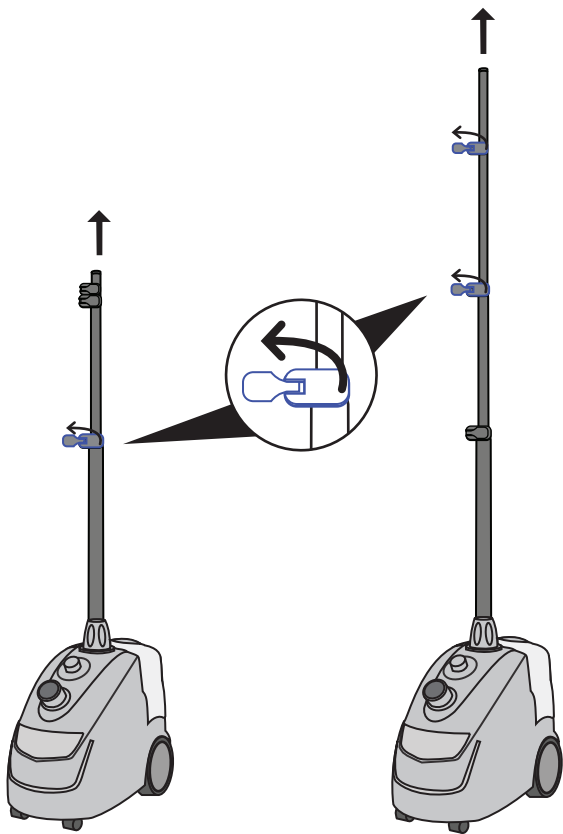

1

2

3

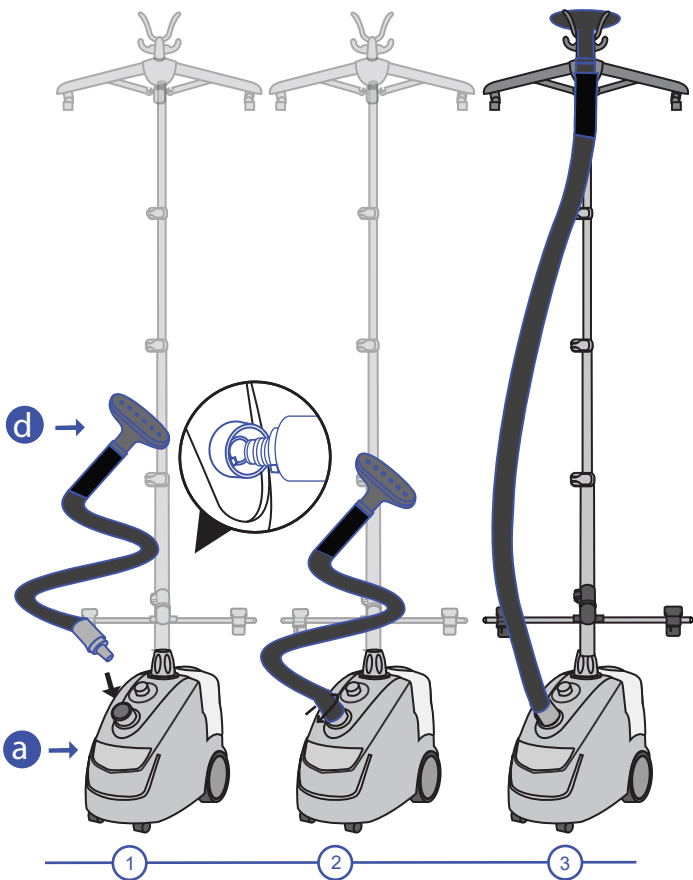

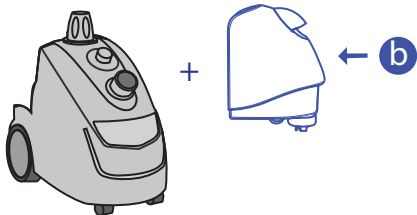

1

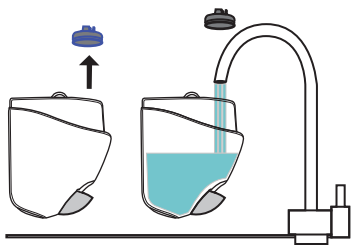

2

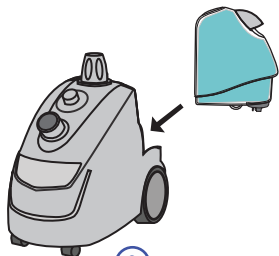

3

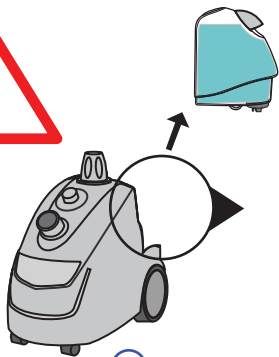

4



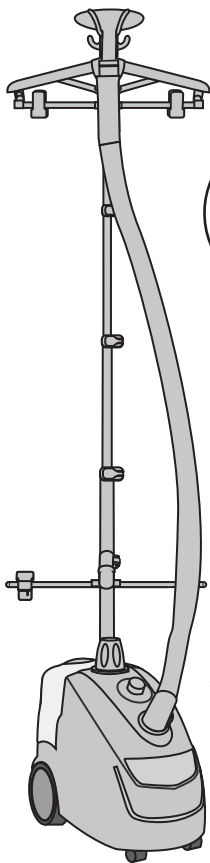

2

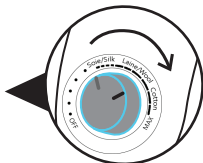

1

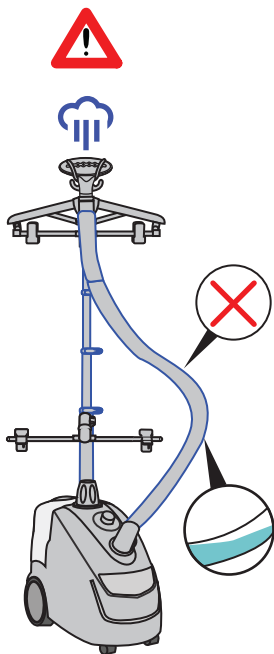



f

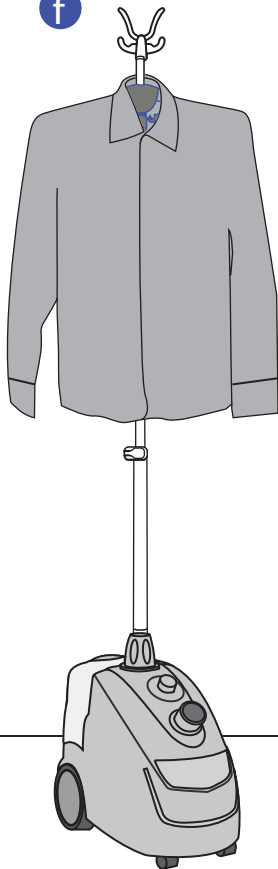

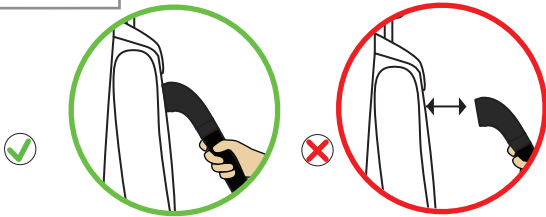

1

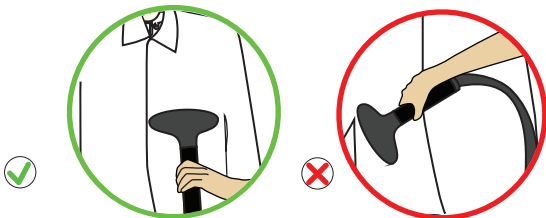

2

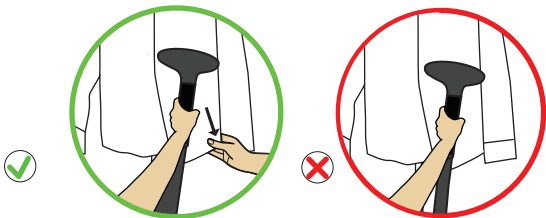

3



OFF



a →

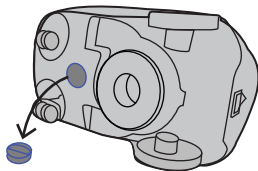
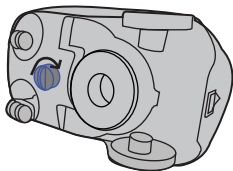
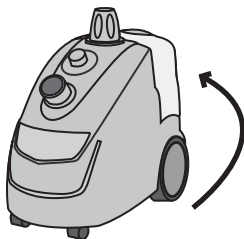

1

b →

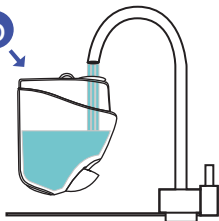

2

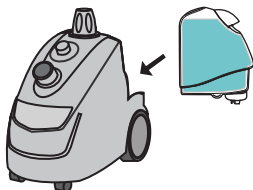

3

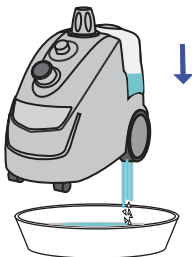

4

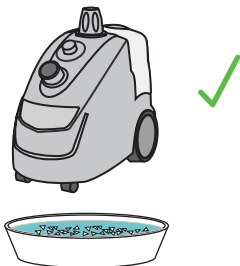

SteamOne

www.steam-one.com