

eve aqua 

Get started

Erste Schritte

Prise en main

Get started • Erste Schritte • Prise en main

①

Insert the included AA batteries before proceeding with the installation.

Setze die mitgelieferten AA-Batterien ein, bevor du mit der Montage beginnst.

Avant de procéder à l'installation, insérez les piles AA incluses.

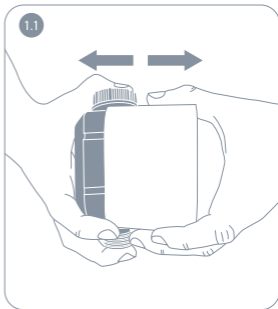

Get started • Erste Schritte • Prise en main

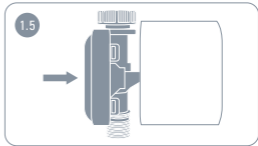
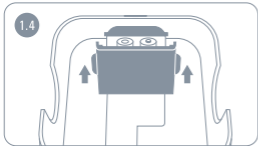
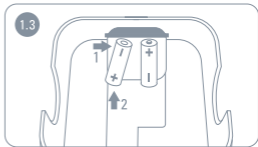
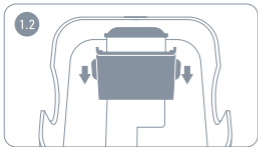

②

Mount Eve Aqua on your faucet and connect a hose.

Montiere Eve Aqua an deinen Wasserhahn und verbinde den Wasserschlauch.

Installez Eve Aqua sur votre robinet et branchez un tuyau d'arrosage.

ⓘ

Attention: Always ensure that Eve Aqua is not exposed to frost.

Achtung: Stelle sicher, dass Eve Aqua keinem Frost ausgesetzt wird.

Attention: Eve Aqua ne doit en aucun cas être exposé au gel.

Get started • Erste Schritte • Prise en main

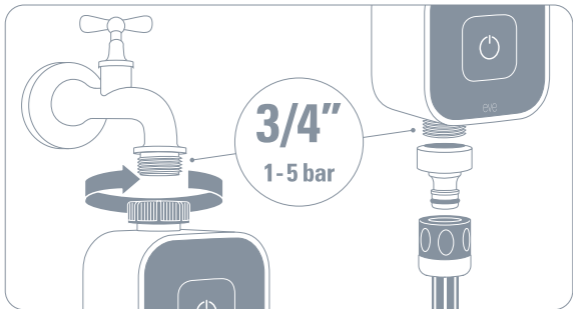

3

Download the Eve app from the App Store.

Lade die Eve App aus dem App Store herunter.

Téléchargez l'app Eve sur l'App Store.

 Eve



Download on the
App Store

Get started • Erste Schritte • Prise en main

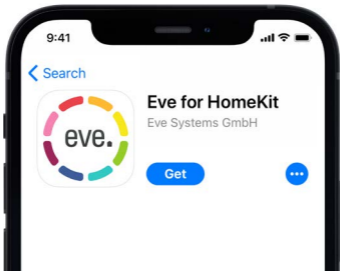

4

Open the Eve app and tap Add Accessory. Eve will now guide you through the setup process.

Öffne die Eve App und tippe auf Zubehör hinzufügen. Eve führt dich nun durch die Einrichtung.

Ouvrez l'app Eve et touchez Ajouter un accessoire. Eve vous guidera alors tout au long du processus de configuration.



Add Accessory

Get started • Erste Schritte • Prise en main

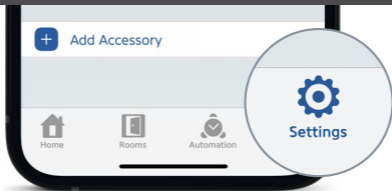

If you have already set up another accessory, go to Settings in Eve to add Eve Aqua to your home.

Wenn du Eve bereits zuvor eingerichtet hast, öffne die Eve-Einstellungen und füge Eve Aqua hinzu.

Si vous avez déjà configuré un autre accessoire, accédez aux réglages d'Eve pour ajouter Eve Aqua à votre domicile.

Enjoy • Viel Spaß • Profitez-en bien

Eve Aqua can be controlled using the Eve app, the Home app, and Siri.

Eve Aqua kann mit der Eve-App, der Home-App und Siri gesteuert werden.

Vous pouvez contrôler Eve Aqua à l'aide de l'app Eve, de l'app Maison et de Siri.



Control
Steuern
Contrôle



Set schedules
(no home hub required)
Zeitpläne erstellen
(keine Steuerzentrale
erforderlich)
Configuration des
programmes (aucun
concentrateur requis)



Enable child lock
Kindersicherung
aktivieren
Activation du
verrouillage enfant



Monitor water
consumption
Wasserverbrauch
überwachen
Suivi de la
consommation



Install firmware
updates
Firmware-Updates
installieren
Installation des mises
à jour du programme
interne



Control
Steuern
Contrôle



Configure guest access
Gastzugriff konfigurieren
Configuration de
l'accès invité



Control
Steuern
Contrôle

⑤

You can also press the button to start and stop watering.

Du kannst die Bewässerung auch über den Knopf starten und stoppen.

Vous pouvez également appuyer sur le bouton pour activer ou désactiver l'arrosage.

ⓘ

Eve Aqua will turn off automatically when the default duration set via the Eve app has expired.

Eve Aqua schaltet sich nach Erreichen der in der Eve-App eingestellten Standarddauer automatisch aus.

Eve Aqua s'éteindra automatiquement au terme du délai d'exécution par défaut.

Enjoy • Viel Spaß • Profitez-en bien

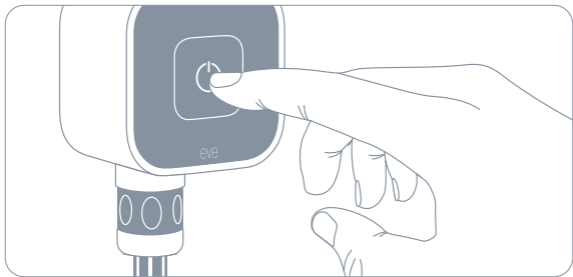

Enjoy • Viel Spaß • Profitez-en bien

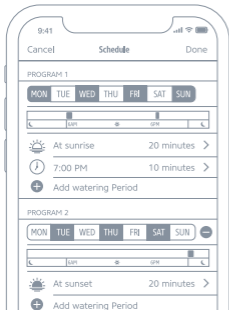

Schedules automatically control Eve Aqua – completely autonomously, independently of your iPhone or home hub. Set schedules to water automatically at specific times using the Eve app.

Mit Zeitplänen wird Eve Aqua automatisch gesteuert – völlig autonom und unabhängig vom iPhone und der Steuerzentrale. Erstelle mit der Eve-App Zeitpläne für die automatische Bewässerung.

Les programmes contrôlent automatiquement Eve Aqua, de façon complètement autonome, indépendamment de votre iPhone ou de votre concentrateur. Configurez des programmes pour un arrosage automatique à l'aide de l'app Eve.

Enjoy • Viel Spaß • Profitez-en bien



Eve is designed to safeguard your personal data. All data is fully encrypted and only transferred directly between your Eve Aqua and iPhone, iPad or home hub.

Learn more at evehome.com/privacy

Eve wurde von Grund auf so entwickelt, dass deine persönlichen Daten geschützt sind. Alle Daten werden vollständig verschlüsselt und nur direkt zwischen Eve Aqua und deinem iPhone, iPad oder deiner Steuerzentrale ausgetauscht. Weitere Informationen findest du unter evehome.com/de/privatsphaere

Eve est conçu pour protéger vos données personnelles. Toutes les données sont entièrement chiffrées. Elles sont toujours transférées directement entre Eve Aqua et votre iPhone, votre iPad ou votre concentrateur. Pour en savoir plus, consultez la page evehome.com/fr/vie-privee

Legal Information • Rechtliche Hinweise • Informations légales

This device complies with part 15 of the FCC Rules and Industry Canada licence-exempt RSS standard(s). Operation is subject to the following two conditions: (1) This device may not cause interference, and (2) this device must accept any interference received, including interference that may cause undesired operation.

This equipment has been tested and found to comply with the limits for a Class B digital device, pursuant to part 15 of the FCC Rules. These limits are designed to provide reasonable protection against harmful interference in a residential installation. This equipment generates, uses and can radiate radio frequency energy and, if not installed and used in accordance with the instructions, may cause harmful interference to radio communications. However, there is no guarantee that interference will not occur in a particular installation. If this equipment does cause harmful interference to radio or television reception, which can be determined by turning the equipment off and on, you are encouraged to try to correct the interference by one or more of the following measures: reorient or relocate the receiving antenna; increase the separation between the equipment and receiver; consult the dealer or an experienced radio/TV technician for help.

This Class B digital apparatus complies with Canadian ICES-003.

This equipment complies with FCC RF, IC RSS-102 and CE radiation exposure limits set forth for an uncontrolled environment. This equipment should be installed and operated with a minimum distance of 20 centimeters between the radiator and your body. This transmitter must not be co-located or operating in conjunction with any other antenna or transmitter.

Changes or modifications not expressly approved by Eve Systems could void your authority to operate this device.

Legal Information • Rechtliche Hinweise • Informations légales

Le présent appareil est conforme aux CNR d'Industrie Canada applicables aux appareils radio exempts de licence. L'exploitation est autorisée aux deux conditions suivantes : (1) l'appareil ne doit pas produire de brouillage, et (2) l'utilisateur de l'appareil doit accepter tout brouillage radioélectrique subi, même si le brouillage est susceptible d'en compromettre le fonctionnement. Cet appareil numérique de la classe B est conforme à la norme NMB-003 du Canada.

Cet équipement est conforme aux CNR-102 d'Industrie Canada. Cet équipement doit être installé et utilisé avec une distance minimale de 20 centimètres entre le radiateur et votre corps. Cet émetteur ne doit pas être co-localisée ou opérant en conjonction avec autre antenne ou émetteur.

For questions about compliance with FCC regulations, please contact: Compliance Officer, Eve Systems, 100 Pine St., Suite 1250, San Francisco CA 94111, USA.

Hereby, Eve Systems declares that this device is in compliance with the essential requirements and other relevant provisions of Directive 2014/53/EC. The declaration of conformity is available at www.evehome.com/doc

Purpose of control: operating control; construction of control: plug-in operating control; type 1 action, operating time: continuous; frequency range: 2402 - 2480 MHz (BLE) / 2405 - 2480 MHz (Thread); EU: max. EIRP: 10 dBm; temperature range: 4 °C - 50 °C

Product: 10ECC8101, 10ECC4101 • Model: 20ECC4101, 20ECC8101 • Part: 51ECC9901
FCC ID: SNE-WHV-003 • IC: 11192A-WHV003



Reset • Zurücksetzen • Réinitialisation

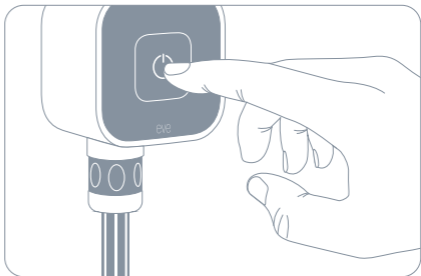
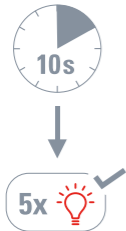



Please keep your HomeKit Setup Code in a safe place.
You need it to securely add Eve to your home, and nobody
but you has a copy.

Bewahre deinen HomeKit-Code an einem sicheren Platz auf.
Du benötigst ihn, um Eve zu deinem Zuhause hinzuzufügen.
Niemand außer dir kennt diesen Code.

Conservez en lieu sûr votre code de configuration HomeKit. Ce code
est indispensable pour ajouter Eve au réseau de votre domicile, et
personne d'autre que vous ne connaît ce code.

Powered by



eve aqua 



Room • Zimmer • Pièce:

Notes • Notizen • Remarques: