

720x120mm



Easy start  
with videos

## Digital Projector Quick Start Guide

Portable Series | GV50

### Package contents

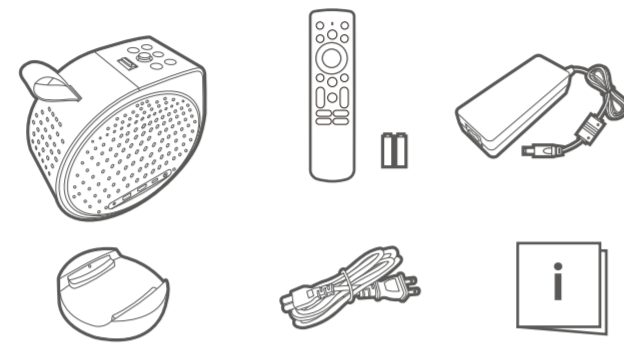

### Setup

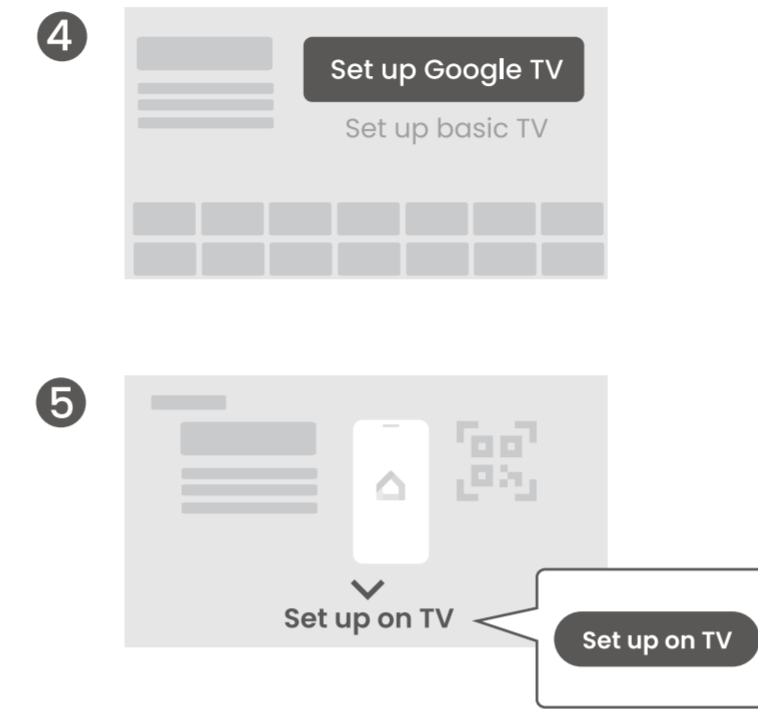
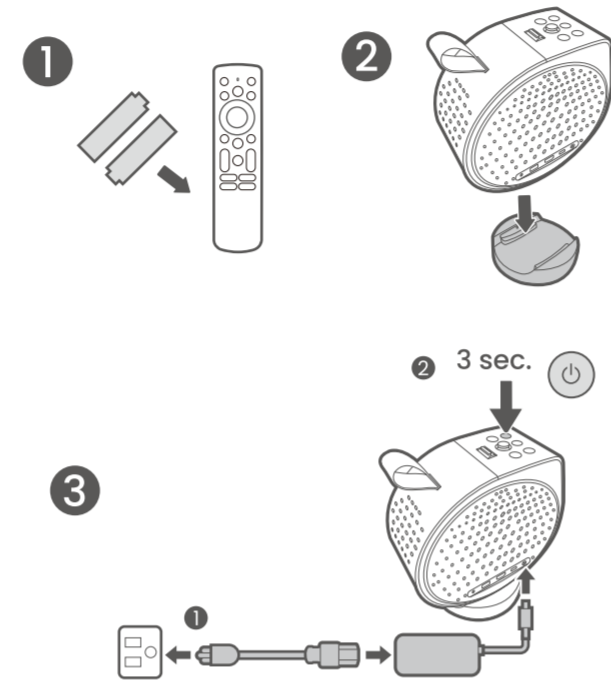

✓ All done. Enjoy!

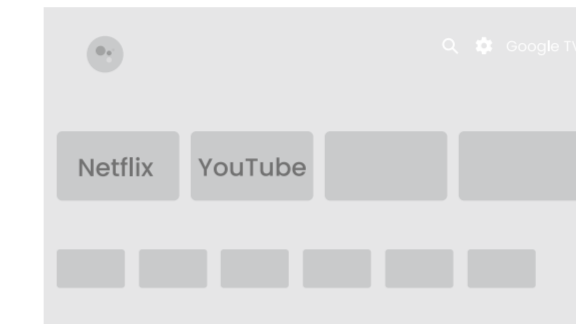

© 2024 BenQ Corporation.  
All rights reserved. Rights of modification reserved.

### Screen adjustment

Projection angle

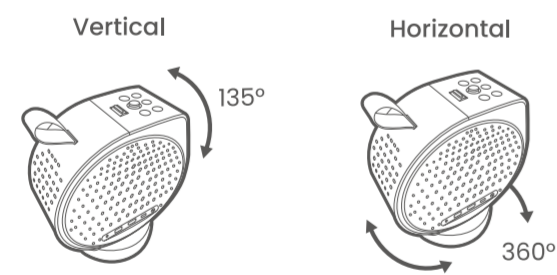

Projection size

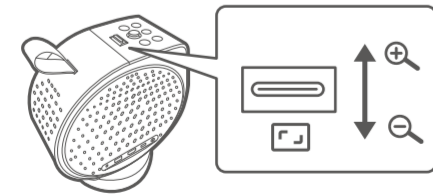

Side projection onto ceiling

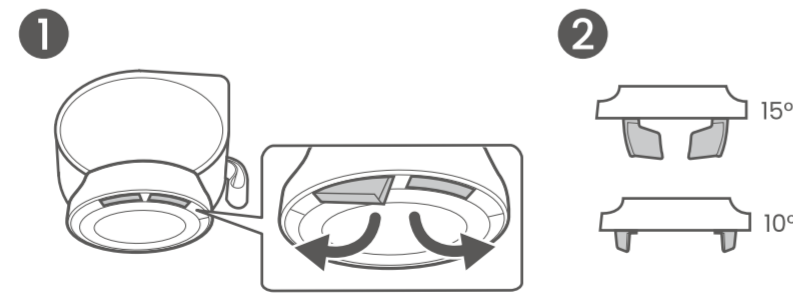
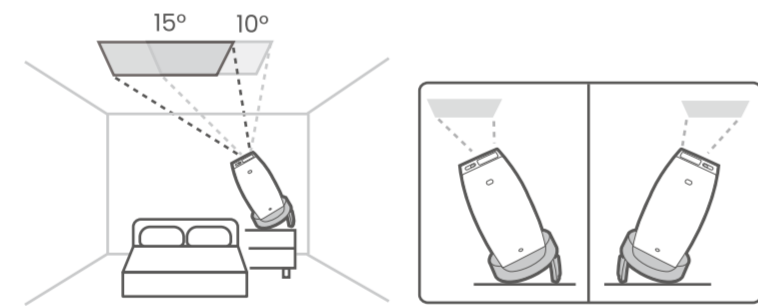

### Screen casting



2  
Android

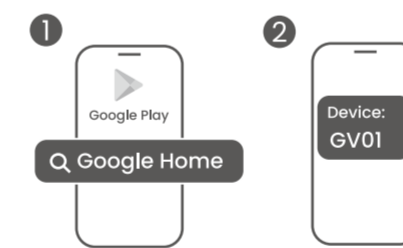

1  
iOS

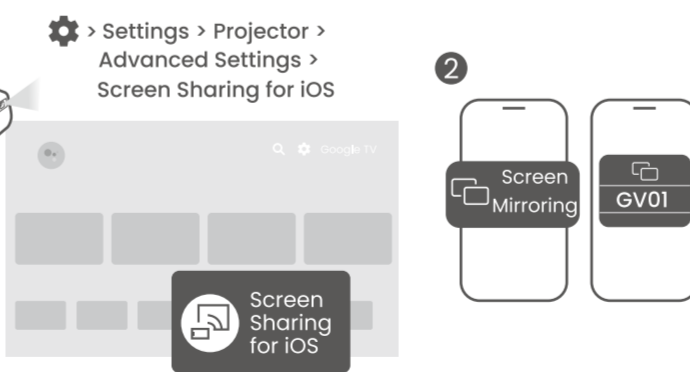

### Helpful apps

BenQ Projector Assistant

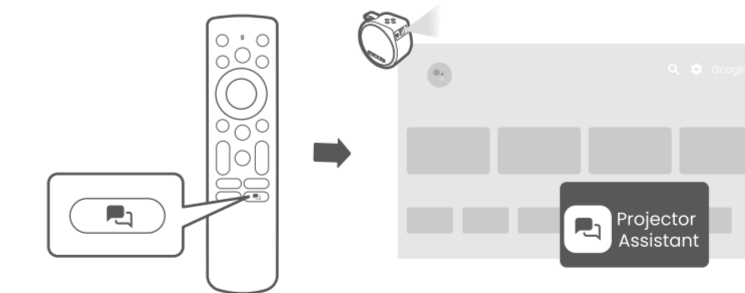

💡 Tips   ? FAQ   🗨️ Contact

Smart Remote for BenQ Projector

