

PRISE EN MAIN
AAN DE SLAG
ERSTE SCHRITTE
KOMMA IGÅNG



Merci d'avoir acheté cet appareil.

Votre cuisinière a été conçue, développée et fabriquée avec amour en Grande-Bretagne. Nous espérons que vous passerez de nombreuses années heureuses à créer des repas et des moments mémorables en famille.

Hartelijk dank voor de aanschaf van dit apparaat.

Uw fornuis is met liefde ontworpen, ontwikkeld en geproduceerd in Groot-Brittannië. We hopen dat u nog vele jaren zult genieten van onvergetelijke maaltijden en momenten met al uw dierbaren.

Vielen Dank für den Kauf dieses Geräts.

Es wurde mit viel Liebe in Großbritannien entworfen, entwickelt und hergestellt. Wir wünschen Ihnen viel Freude mit Ihrem neuen Herd, der Ihnen jahrelang dabei helfen wird, unvergessliche Familienmahlzeiten und Momente zu schaffen.

Tack för att du har köpt den här produkten.

Den här konstruerats, formgivits, utvecklats och tillverkats med omsorg i Storbritannien. Vi hoppas att du ska få många glada år och många fina minnen från familjemiddagar och andra möten och evenemang.

Avant de commencer

- Assurez-vous que **TOUS** les matériaux d'emballage ont été retirés.
- Réglez l'horloge à la bonne heure.
- Assurez-vous que la pièce est bien ventilée.
- Réglez les fours à 200 °C et faites-les fonctionner pendant au moins une heure pour éliminer les odeurs de fabrication.
- Mettez le gril en marche et faites-le fonctionner pendant 30 minutes avec la lèchefrite en position, poussée à fond vers l'arrière et la porte du gril ouverte.
- Une fois l'appareil refroidi, essuyez les surfaces en émail et en verre à l'aide d'un chiffon humide propre et non pelucheux.
- Les plaques de cuisson à induction requièrent certaines casseroles pour un fonctionnement optimal. Voir les performances des casseroles à la page 16.
- Pour de plus amples informations, y compris le mode d'emploi complet, les informations techniques et d'installation, veuillez consulter **la section** Assistance complémentaire à la page 79.

Disposition de votre appareil

Modèles de 110 cm

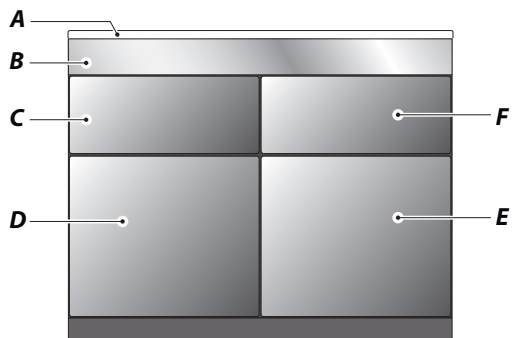
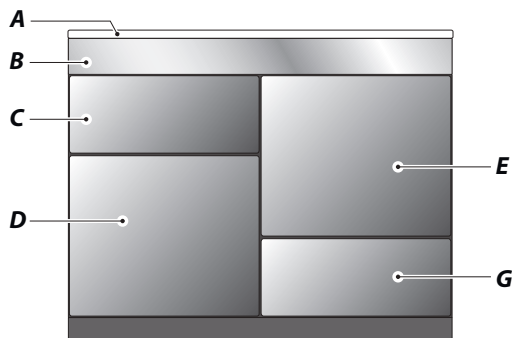

Modèles de 90 cm et 100 cm

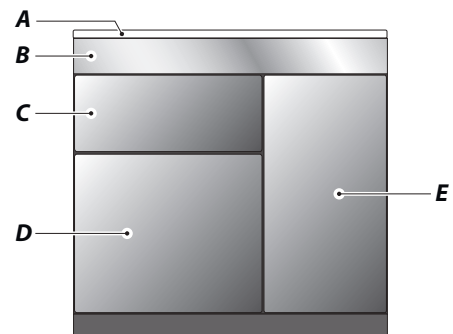

Cavité unique

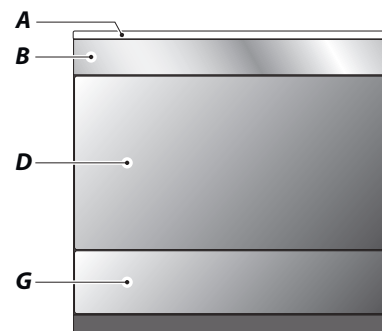









































































































































































- A. Table de cuisson**
- B. Panneau de commande**
- C. Gril**
- D. Four multifonction / ventilé**
- E. Four ventilé**
- F. Four à cuisson lente**
- G. Tiroir de levage/stockage**

Accessoires fournis























































-  Fourni avec les appareils à induction
-  Fourni avec l'appareil
-  Fourni avec les appareils mixtes
-  Disponible en option

Toutes les tailles sont exprimées en centimètres

	90/100	110	110 uniquement	90/100	110	Lèche-frite	Glissières télescopiques	Grille plate Four principal	Grille pour le grand four	Égouttoir	Handyrack et plateau
Support pour wok											
Gril classique											
Gril Deluxe											
Gril à induction											
Cotswold											
Camden											
Estate											
Classic											
Infusion Classic											
Professional +											
Infusion											
Toledo											
Longstock											
Classic Deluxe											
Estel Deluxe											
Leckford Deluxe											
Professional Deluxe											
Longstock Deluxe											
Encore Deluxe											
Edge Deluxe											
Arina Nexus											
Elise											
Stanley Supreme											

Accessoires fournis - Cavité unique

-  Fourni avec les appareils à induction
-  Fourni avec l'appareil
-  Fourni avec les appareils mixtes
-  Disponible en option

	Support pour wok	Gril classique	Gril à induction	Grille à cavité unique	Support de la lèche-frite	Lèche-frite	Gril sur pied	Demi-grille	Panneau d'économie d'énergie
Classic Deluxe				 x2	 x1	 x2	 x2	 x3	 x1
Estel Deluxe				 x2	 x1	 x2	 x2	 x3	 x1
Professional Deluxe				 x2	 x1	 x2	 x2	 x3	 x1
Arina				 x2	 x1	 x2	 x2	 x3	 x1
Nexus				 x2	 x1	 x2	 x2	 x3	 x1
Elise				 x2	 x1	 x2	 x2	 x3	 x1

Prise en main

Régler l'horloge

L'horloge doit être réglée à l'heure du jour avant la mise en marche des fours.

Step. 1



Appuyez sur le bouton de l'horloge [🕒] ou utilisez simultanément les boutons [+] et [-] pour accéder au mode de réglage de l'horloge. Le point décimal [·] clignote.

Step. 2

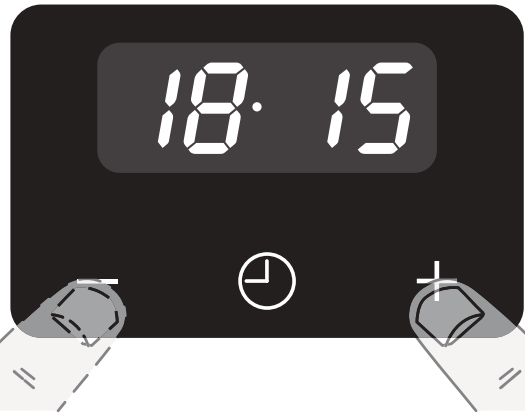





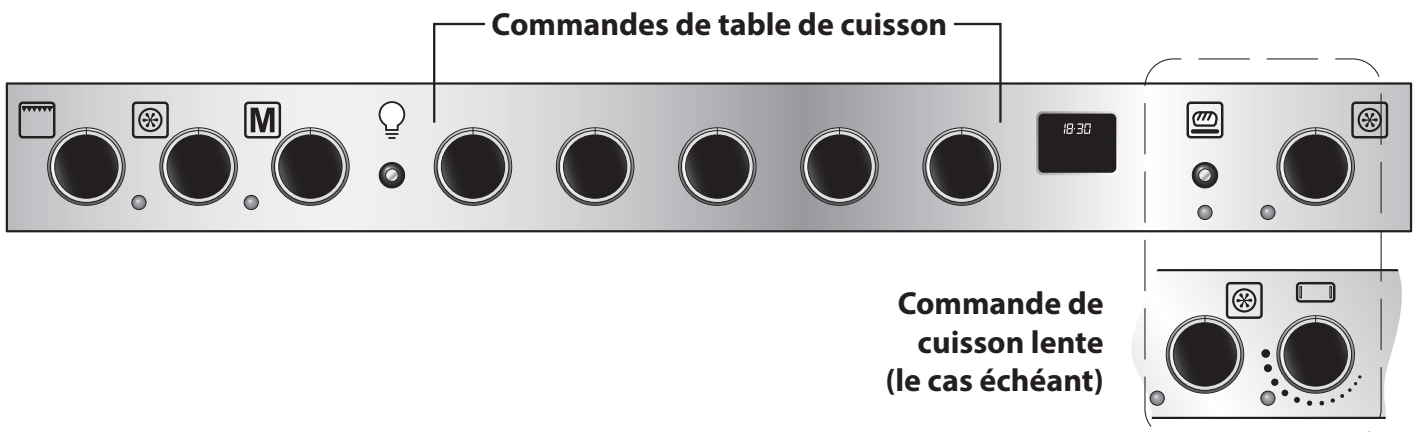

Utilisez les boutons [+] ou [-] pour régler l'heure correcte. Appuyez sur le bouton de l'horloge [🕒] pour confirmer.

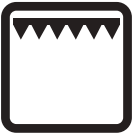
Identification des lampes, du four et du gril

Les illustrations à côté de chaque bouton sont fournies à titre indicatif et peuvent ne pas correspondre à celles de votre appareil.



						
Gril	Commande de la température du four du côté gauche	Sélecteur de four multifonction (le cas échéant)	Lampe du four	Compartment étuve	Four à cuisson lente	Commande de la température du four du côté droit

Identification des lampes et du four - Cavité unique

Les illustrations à côté de chaque bouton sont fournies à titre indicatif et peuvent ne pas correspondre à celles de votre appareil.

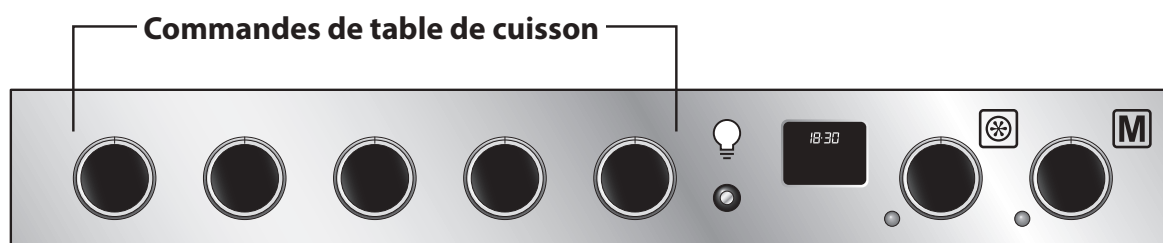

		
Commande de température	Sélecteur de four multifonction	Lampe du four

Le Gril

Fonctionnement du gril

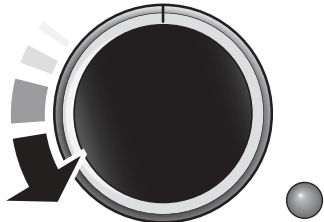
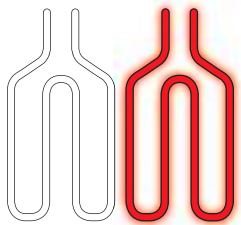

Pour activer le demi-élément

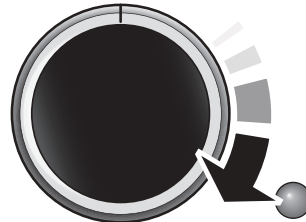

Pour activer les deux éléments

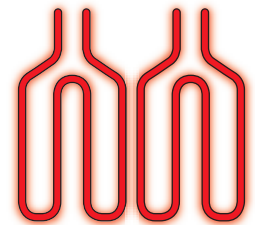

Réglage de la hauteur des pieds du gril

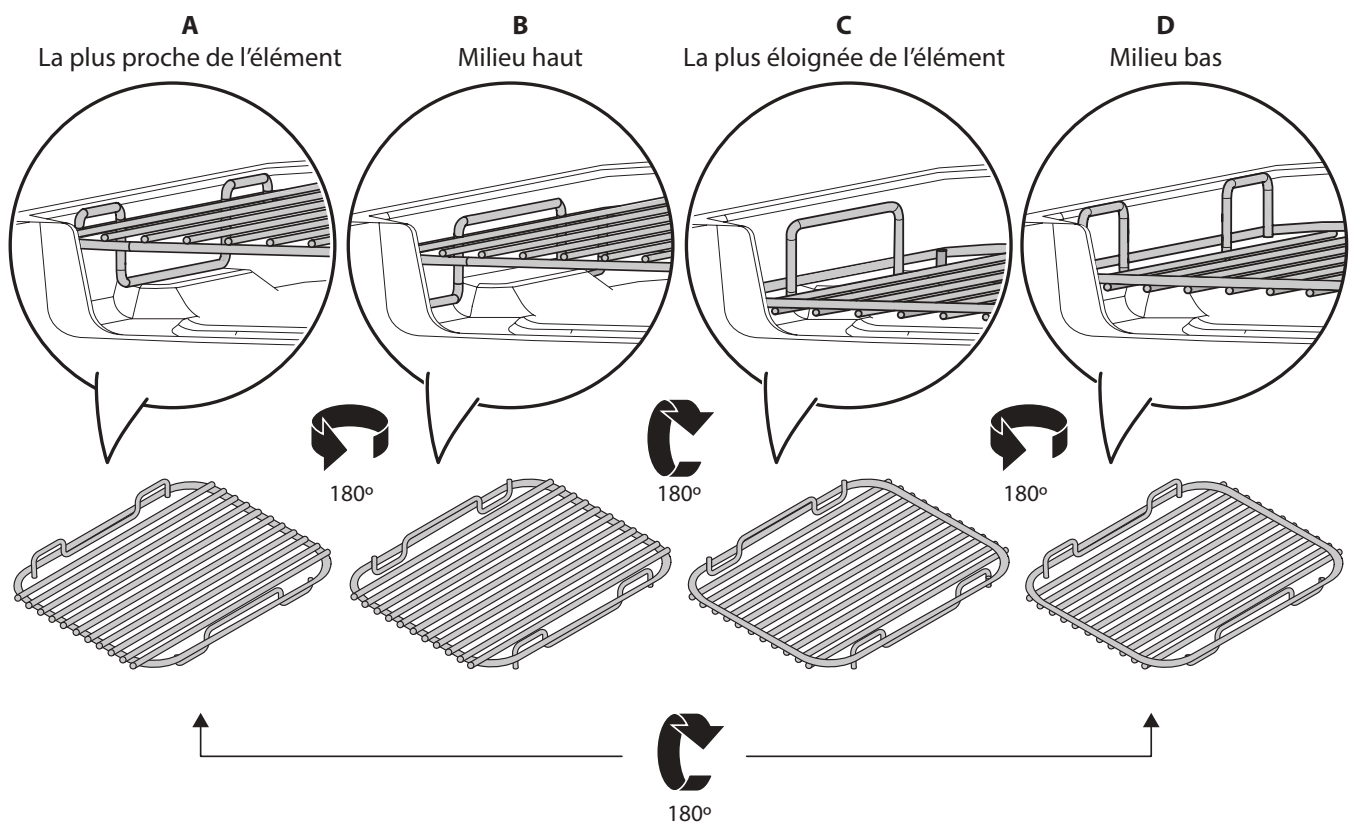

Installation de la glissière télescopique du grill

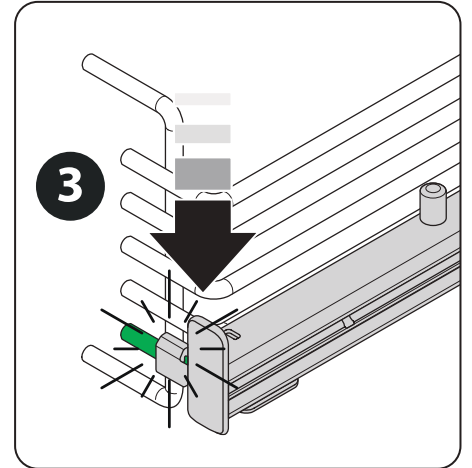
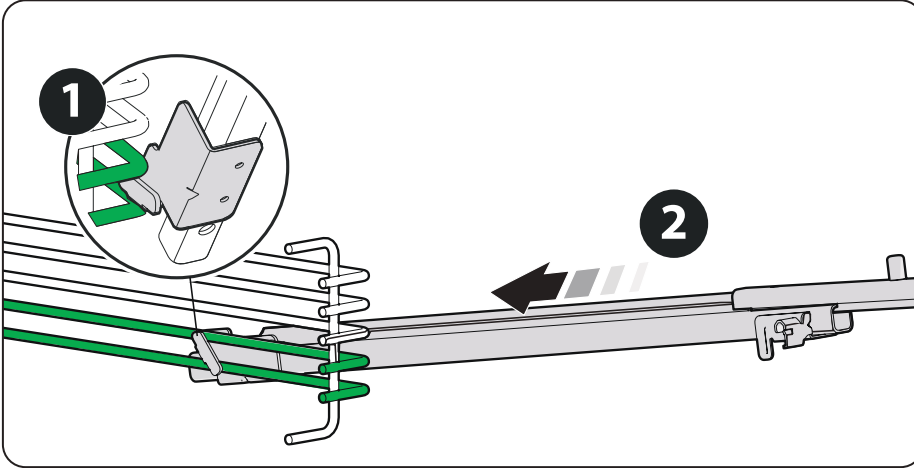

Installation / retrait de la lèchefrite

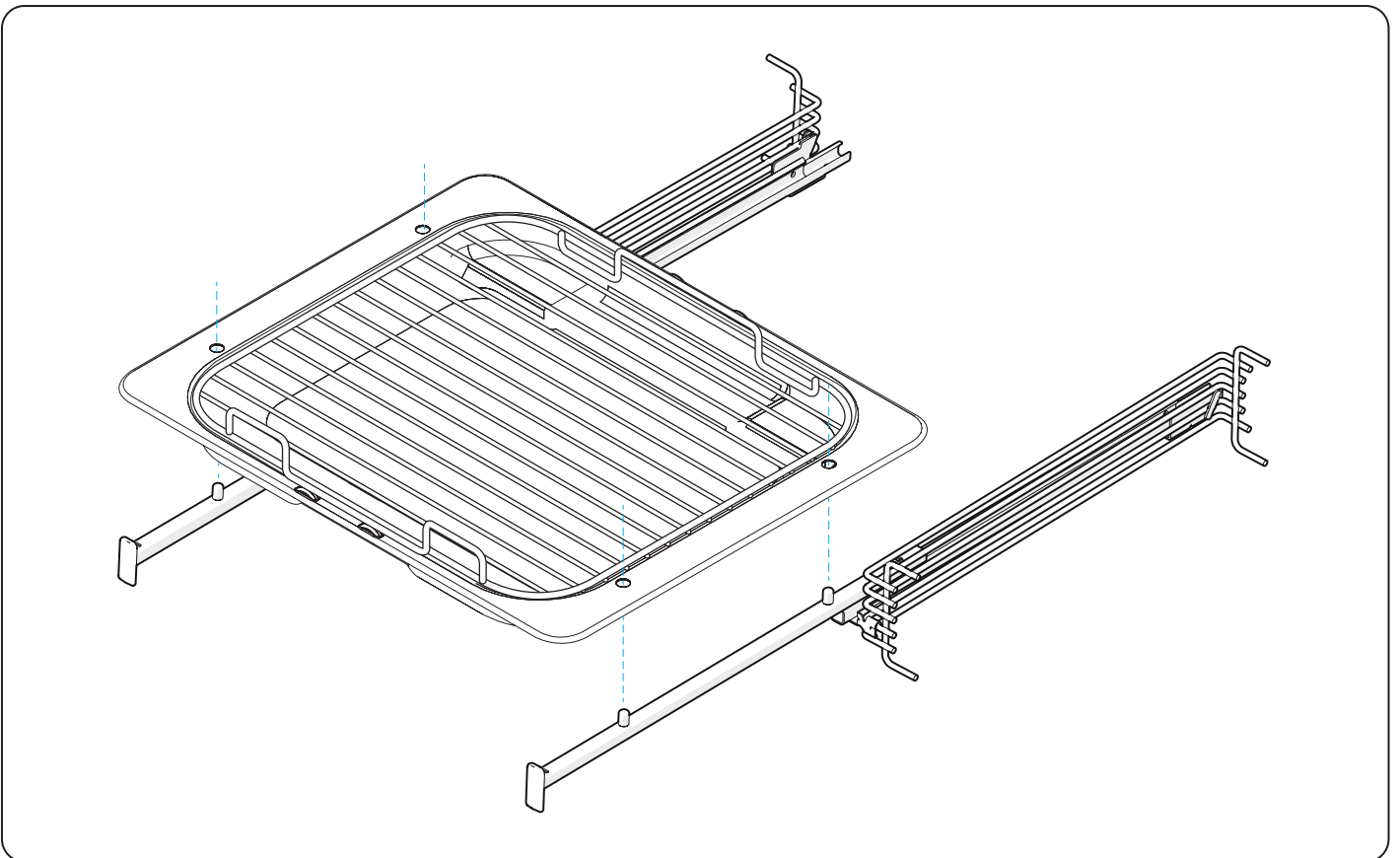

Positions de la lèchefrite

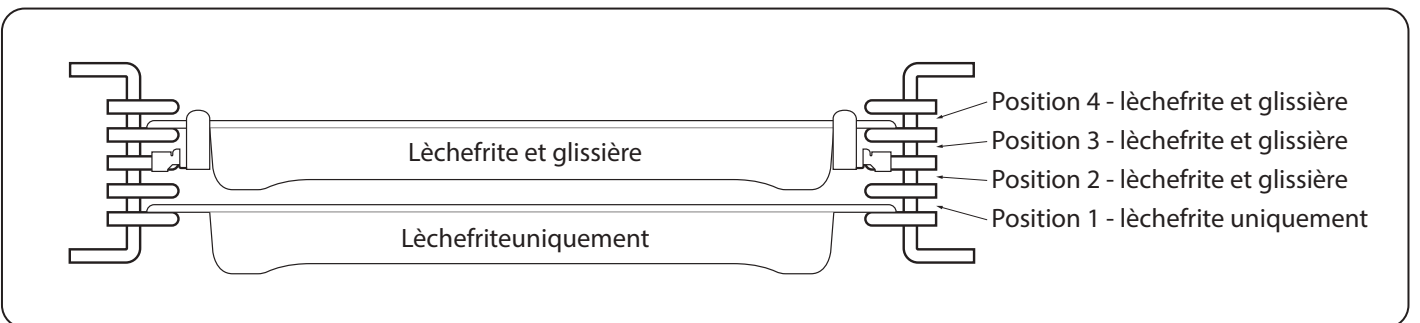

Les fours

Symboles du four multifonction

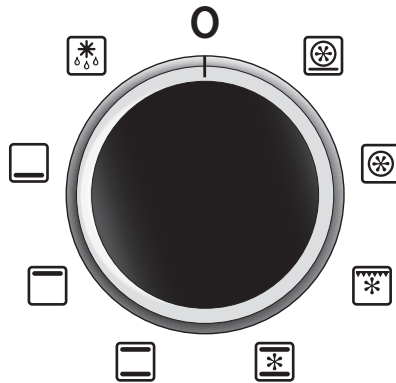

Duo	Four à chaleur tournante	Grill à chaleur tournante	Chaleur tournante	Conventionnel	Brunissement	Chaleur de base	Décongélation

Pour en savoir plus sur ces fonctions, veuillez consulter le mode d'emploi complet.

Fonctionnement du four multifonction

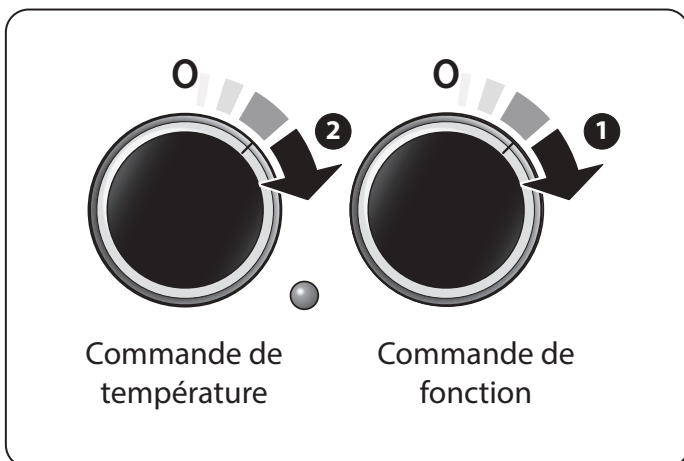

Fonctionnement du four à chaleur tournante

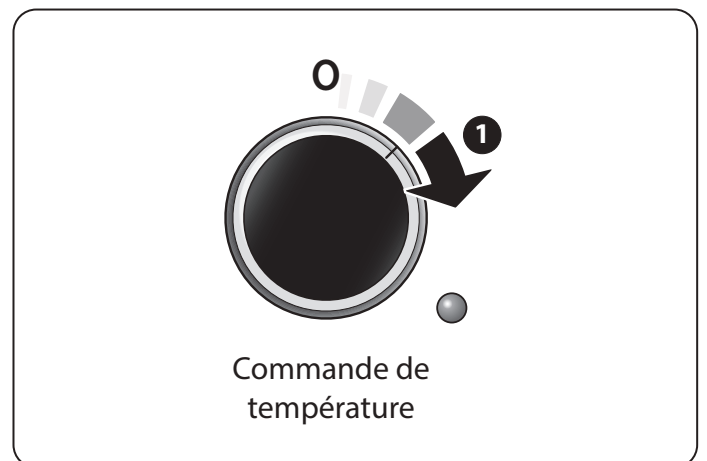

Installation de la grille du four

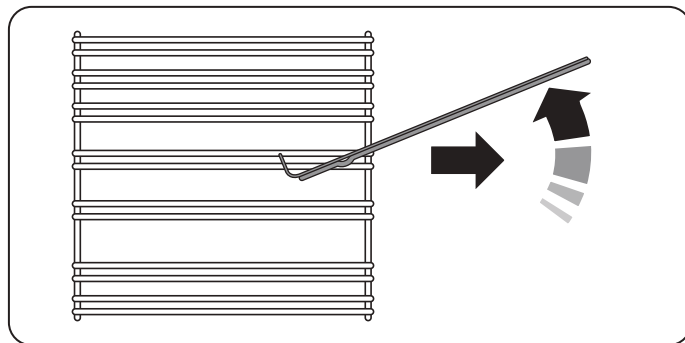
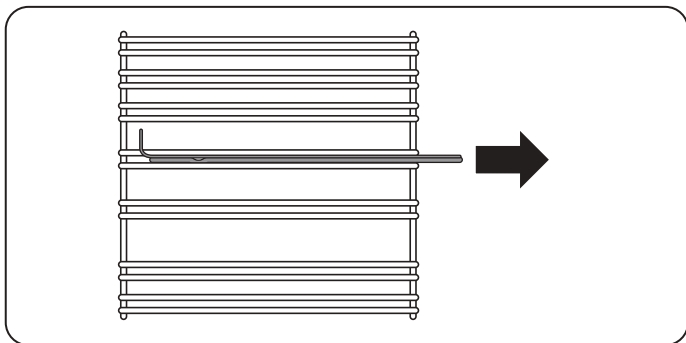

Installation de la grille télescopique du four

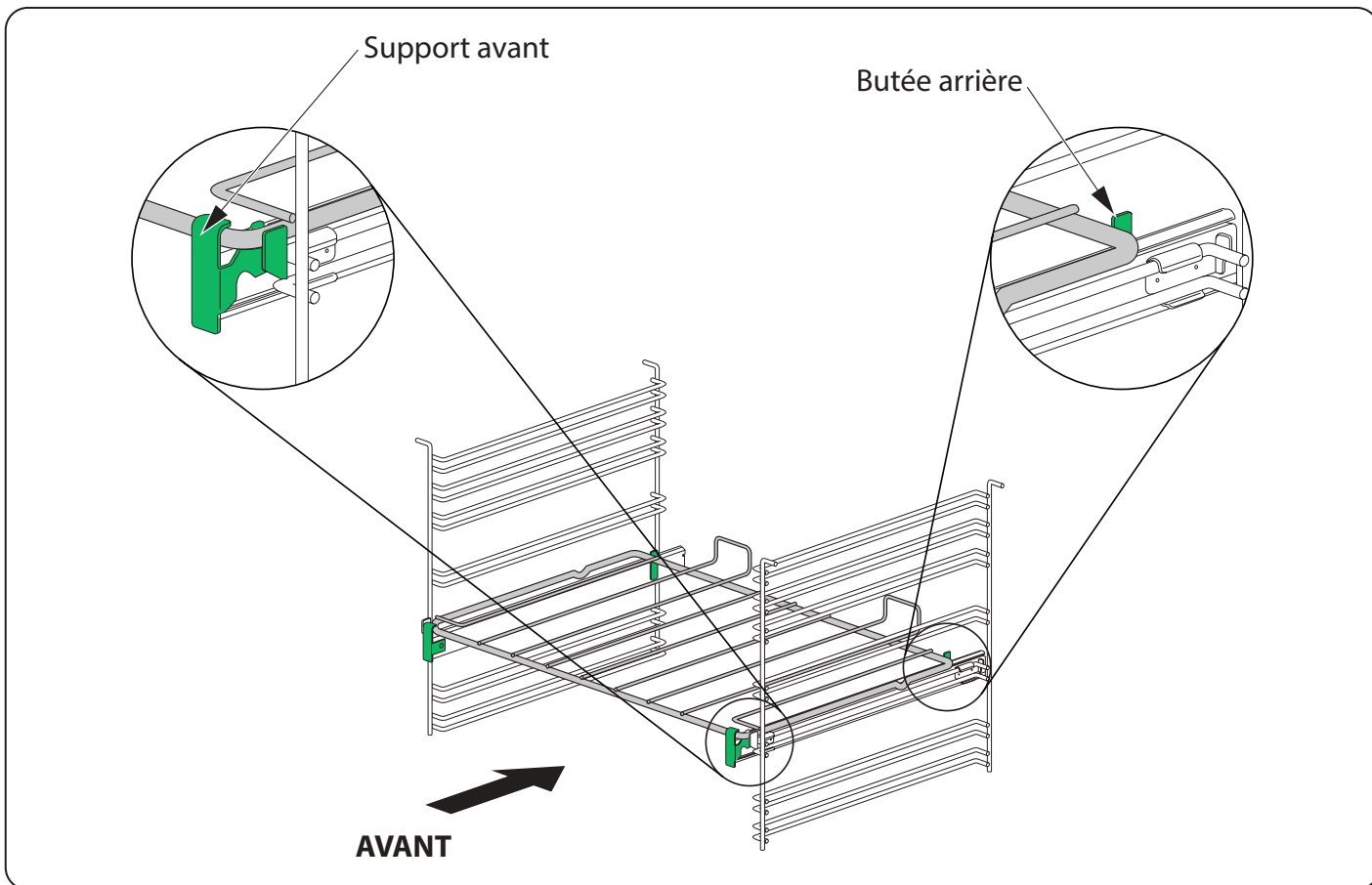
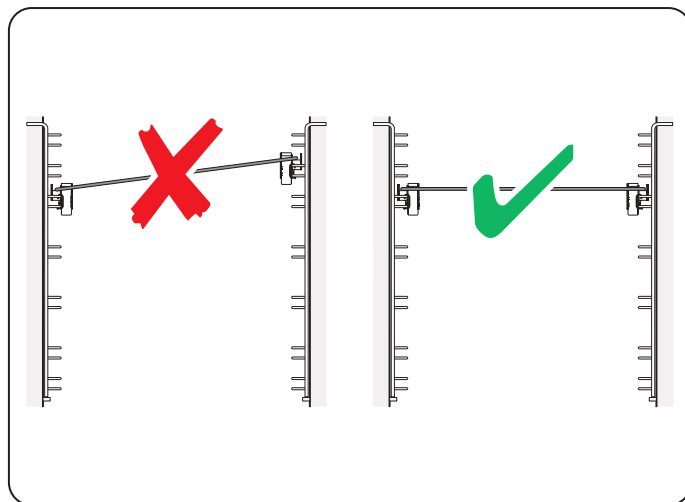
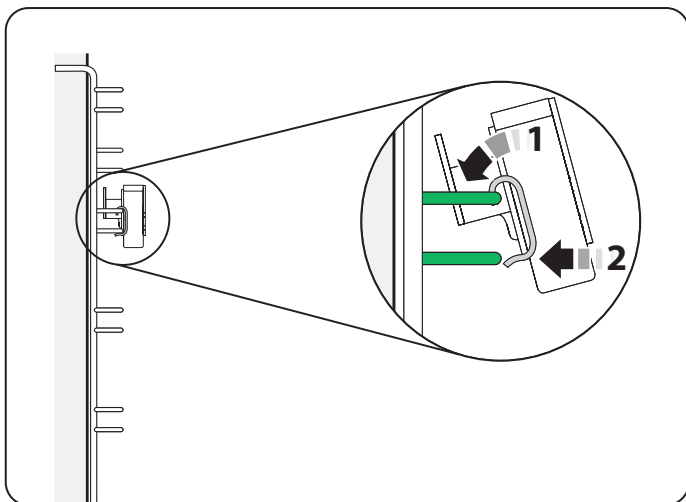

Cavité unique - Panneau d'économie d'énergie

Insertion du panneau d'économie d'énergie

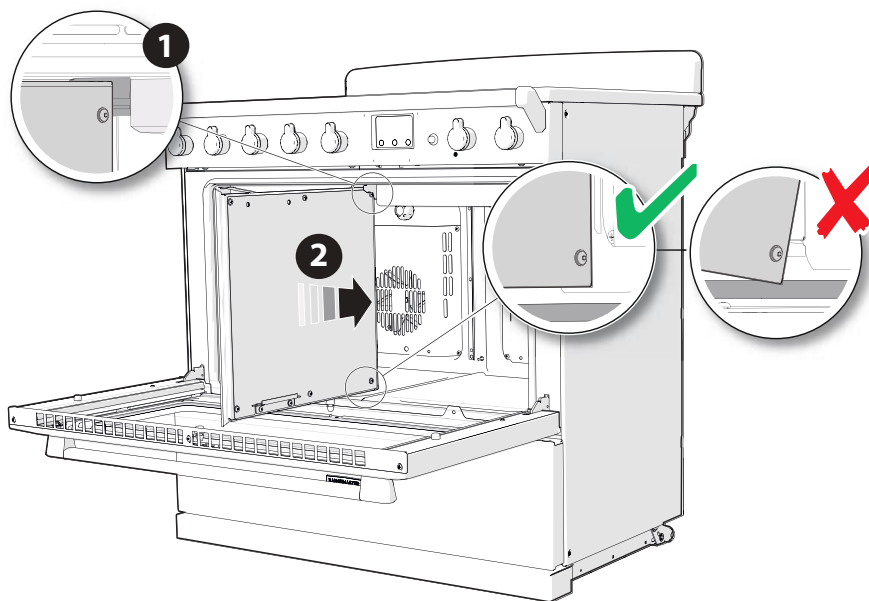

Rentrez le joint en caoutchouc le long du bord intérieur du verre.

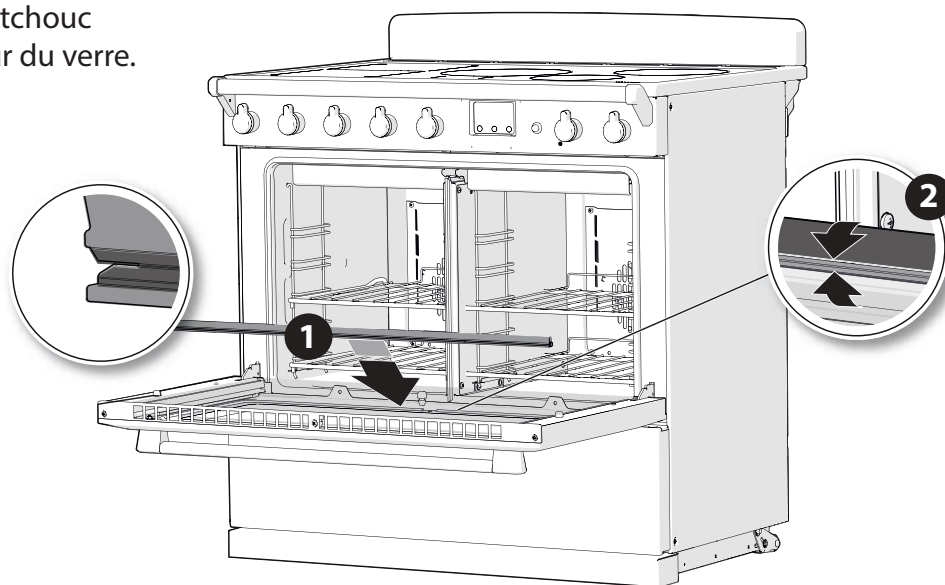

Panneau d'économie d'énergie

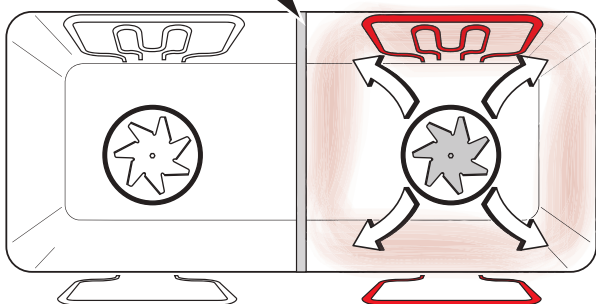

Retrait du panneau d'économie d'énergie

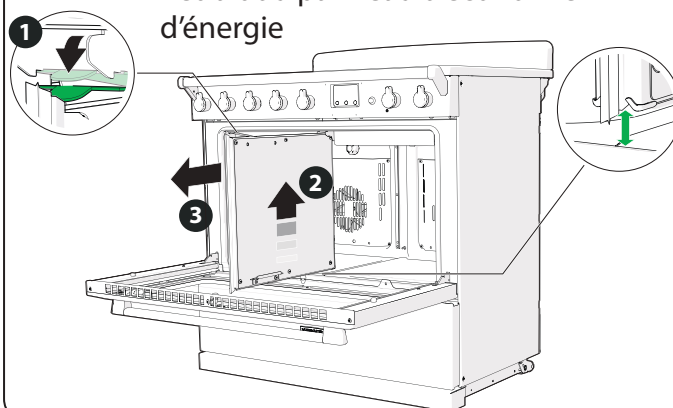

Plaque de cuisson - Disposition et fonctionnement

Mixte

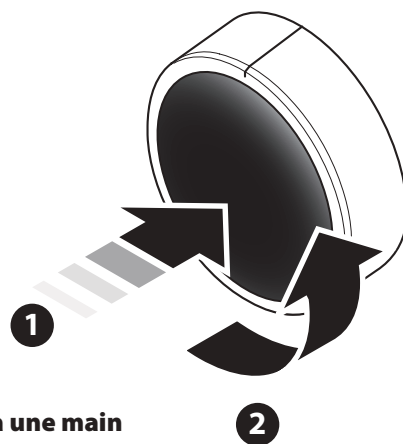
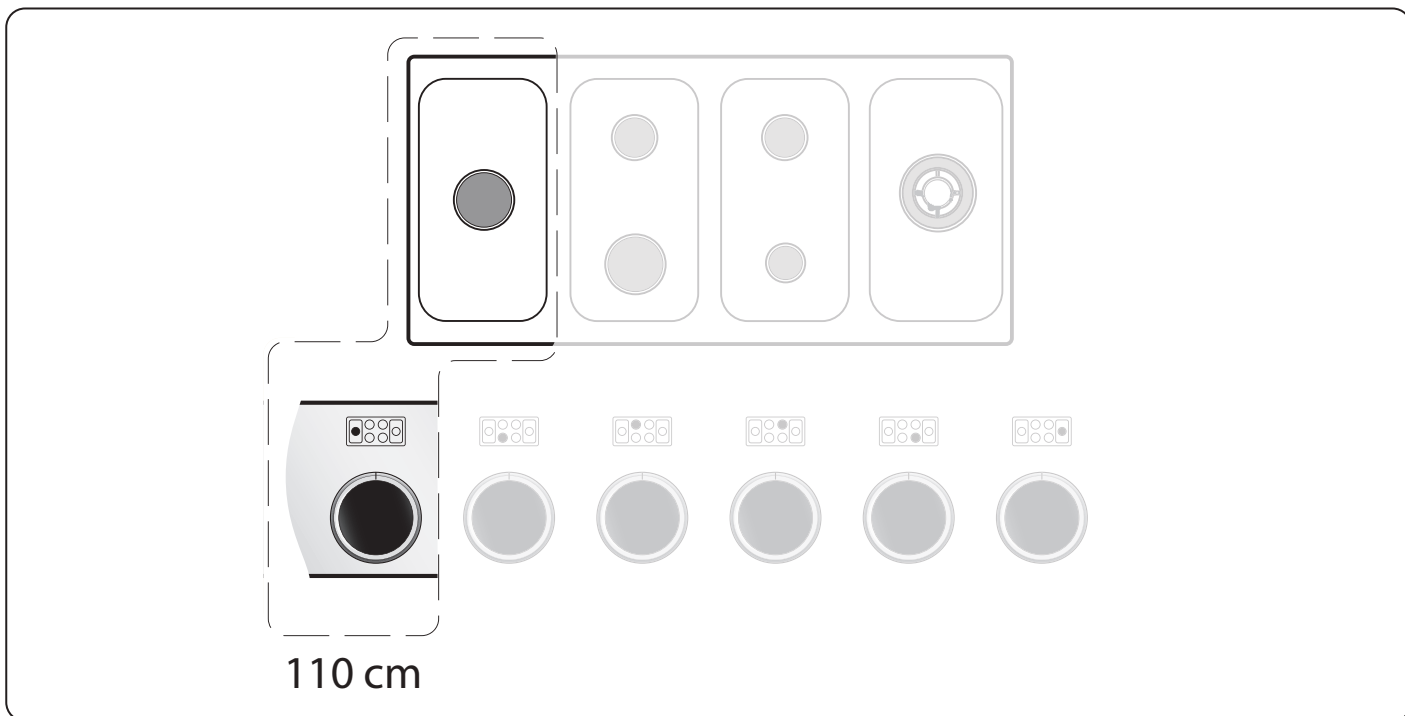

Allumage à une main

Modèles de 110 cm avec zone multiple

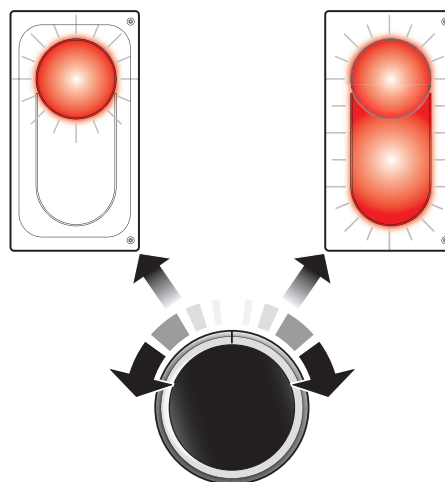
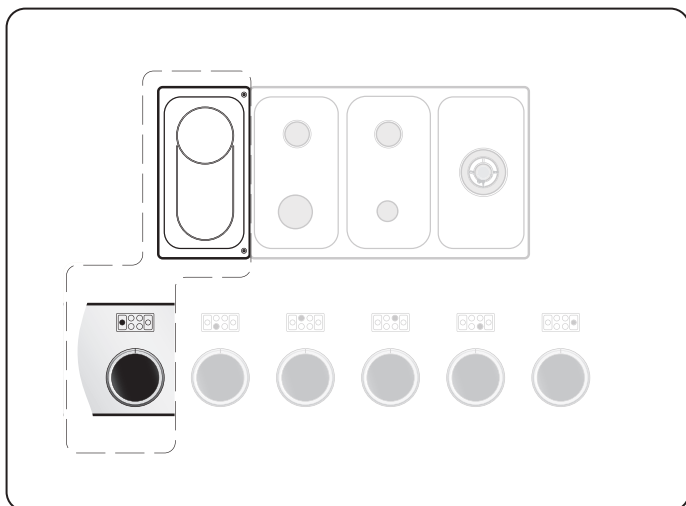

Plaque de cuisson - Disposition et fonctionnement

Induction pour Kitchener

Vérification de la performance de la casserole

Utilisez une zone de 1,85 kW (reportez-vous au manuel pour connaître les caractéristiques de chaque zone).

Remplissez une casserole sans couvercle avec 1/2 litre d'eau à température ambiante (le diamètre de la casserole ne doit pas être supérieur au cercle extérieur de la zone).

Disposition de la plaque à induction.

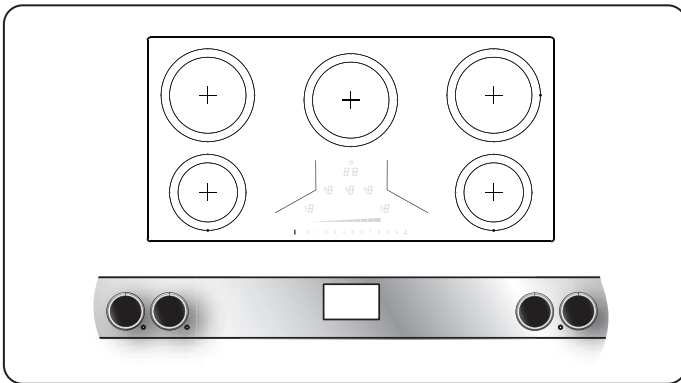

Faites fonctionner la zone au niveau de puissance 9.

L'eau doit bouillir dans les 3 ½ minutes.

Des temps d'ébullition ne correspondant pas à cette durée suggèrent que la conception de la casserole n'est pas idéale pour fournir les meilleures performances et une défaillance prématurée des composants peut en résulter.

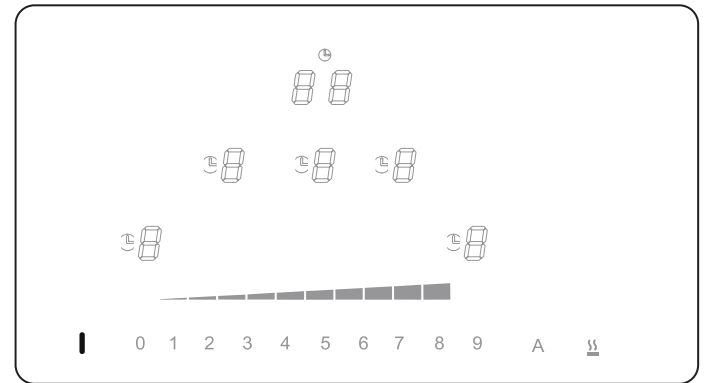

Symboles de l'induction

Pour sélectionner les fonctions, appuyez sur les symboles correspondants sur le panneau d'affichage.

Séquence d'opération [Appuyer Appuyer et glisser]	Affichage	Fonction
	CL	• Mise sous tension et minuterie prête
0 → ∞	Flash - ∞ 0 1	• Paramètres de température basse - Niveau 1 uniquement
0 → A	A	• Chauffage automatique (si disponible)
CL → 0 → 0 1 2 3	99	• Réglage de la minuterie, avec un maximum de 99 minutes. • Minuterie de 1 minute ; compte à rebours à partir de 59 secondes.

Affichage	Fonction
0...9 0 1 2 3 4 5 6 7 8 9	• Réglages de température - Niveau 1 à 9
P	• Réglage Power Boost
H	• Indicateur de chaleur résiduelle
U	• Détecteur de casseroles
0	• Casserole/Poêle détectée sur la zone correspondante
E #	• Demande de support de service
ER	
EH	
Er	

Plaque de cuisson - Disposition et fonctionnement

Induction pour Professional+ / Professional Deluxe

Vérification de la performance du casseroles

1. Placez-la sur les zones de cuisson concernées pour l'évaluation.
2. Appuyez sur , puis appuyez sur 3 fois.
3. Appuyez sur .

La zone commence à évaluer la casserole, et la séquence clignotante affichera .

Lorsque la vérification est terminée, l'affichage montre :-

Grade 3 [] signifie Excellent; performance de cuisson optimale.

Grade 2 [] signifie Moyen; performance de cuisson réduite.

Grade 1 [] signifie Faible.

Disposition de la plaque à induction

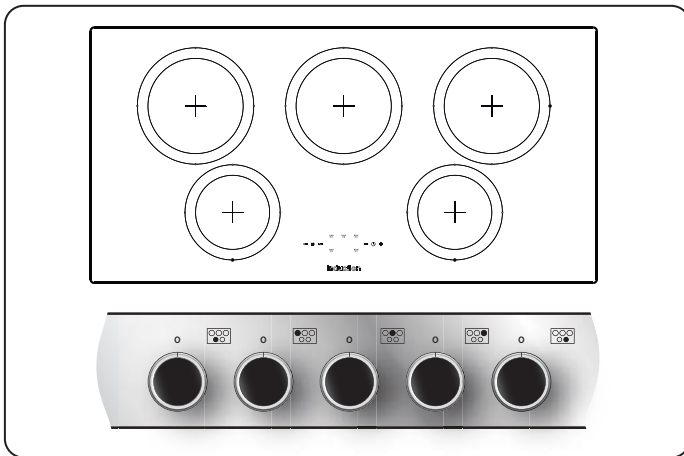

Disposition avec zone de pont

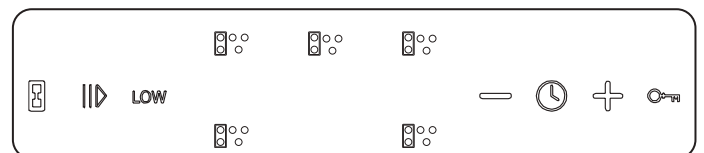
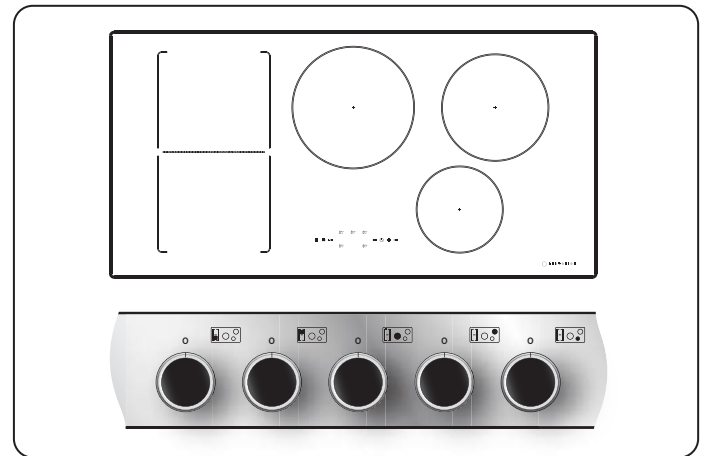

Symboles de l'induction

Pour sélectionner les fonctions, appuyez sur les symboles correspondants sur le panneau d'affichage.

Séquence d'opération [Appuyez sur]	Affichage	Fonction
	L	• Verrou enfant
		• Activer/Désactiver la zone de pont
		• Mettre en pause toutes les zones de cuisson
→	TIMER 99	• Réglage du minuteur, avec un maximum de 99 minutes.
LOW →	LOW 1...2...3	• Réglages de basse température - Niveau 1 à 3 uniquement

Affichage	Fonction
1...9	• Réglages de température - Niveau 1 à 9
P	• Réglage Power Boost
H	• Indicateur de chaleur résiduelle
	• Demande de support de service
	• Détecteur de casseroles

Plaque de cuisson - Disposition et fonctionnement

Induction

Disposition de la plaque à induction.

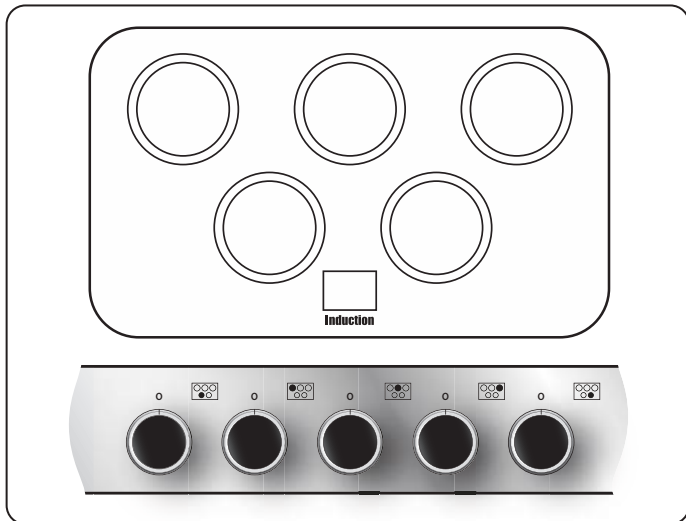

Disposition avec zone de pont.

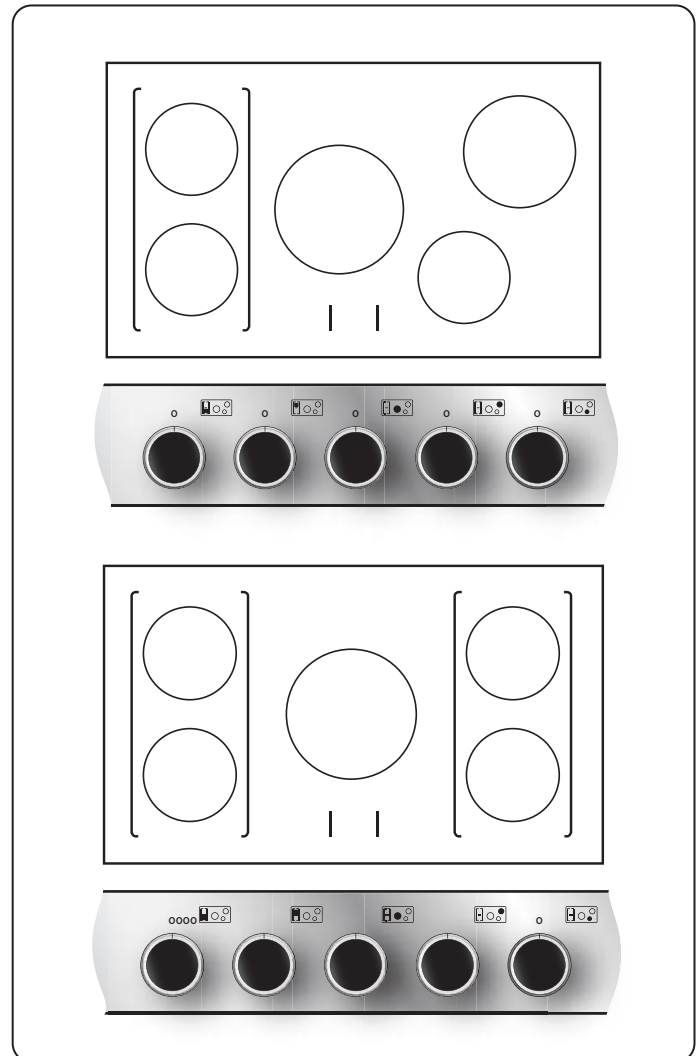

Vérification de la performance de la casserole

Utilisez une zone de 1,85 kW (reportez-vous au manuel pour connaître les caractéristiques de chaque zone).

Remplissez une casserole sans couvercle avec 1/2 litre d'eau à température ambiante (le diamètre de la casserole ne doit pas être supérieur au cercle extérieur de la zone).







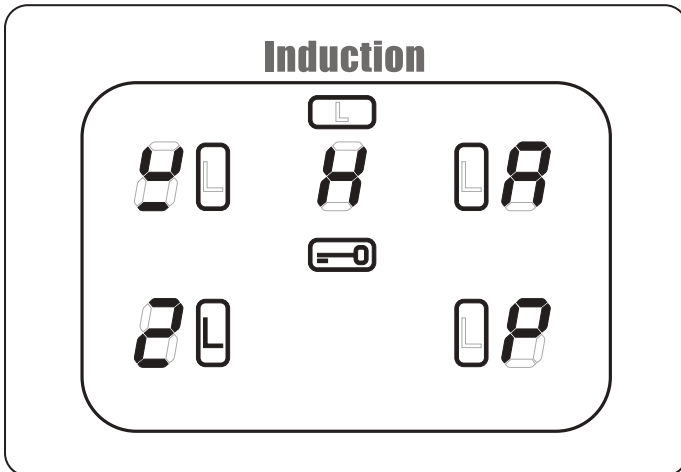

Faites fonctionner la zone au niveau de puissance 9.

L'eau doit bouillir dans les 3 ½ minutes.

Des temps d'ébullition ne correspondant pas à cette durée suggèrent que la conception de la casserole n'est pas idéale pour fournir les meilleures performances et une défaillance prématurée des composants peut en résulter.

Symboles de l'induction



U	Détecteur de casseroles
H	Indicateur de chaleur résiduelle
A	Chauffage automatique - si disponible
	Verrou enfant
	Réglage basse température 1 - Fondre:  2 - Mijoter: 
	Réglage basse température 1 - Fondre:  2 - Garder au chaud:  3 - Mijoter: 
1...9	Réglages de température - Niveau 1 à 9
P	Réglage Power Boost
E 2	La température de la casserole ou du verre est trop élevée. Laissez le système refroidir.
E 3	Ustensile de cuisson inadapté ; effectuez le test de performance de la casserole ou essayez un autre ustensile.
Er - E	Effectuez une réinitialisation manuelle. Si le problème persiste, contactez le service client.

Plaque de cuisson - Disposition et fonctionnement

Céramique

Disposition 110 cm

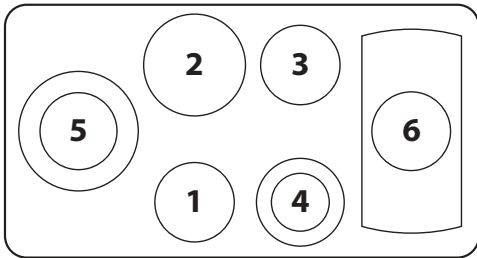

Disposition 90 cm et 100 cm

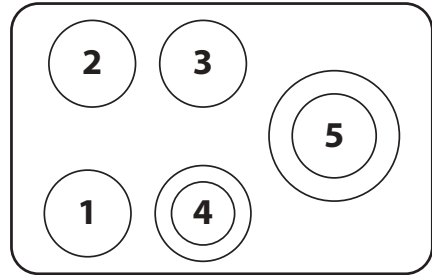

Positions de la plaque de cuisson à élément double - 4 et 5

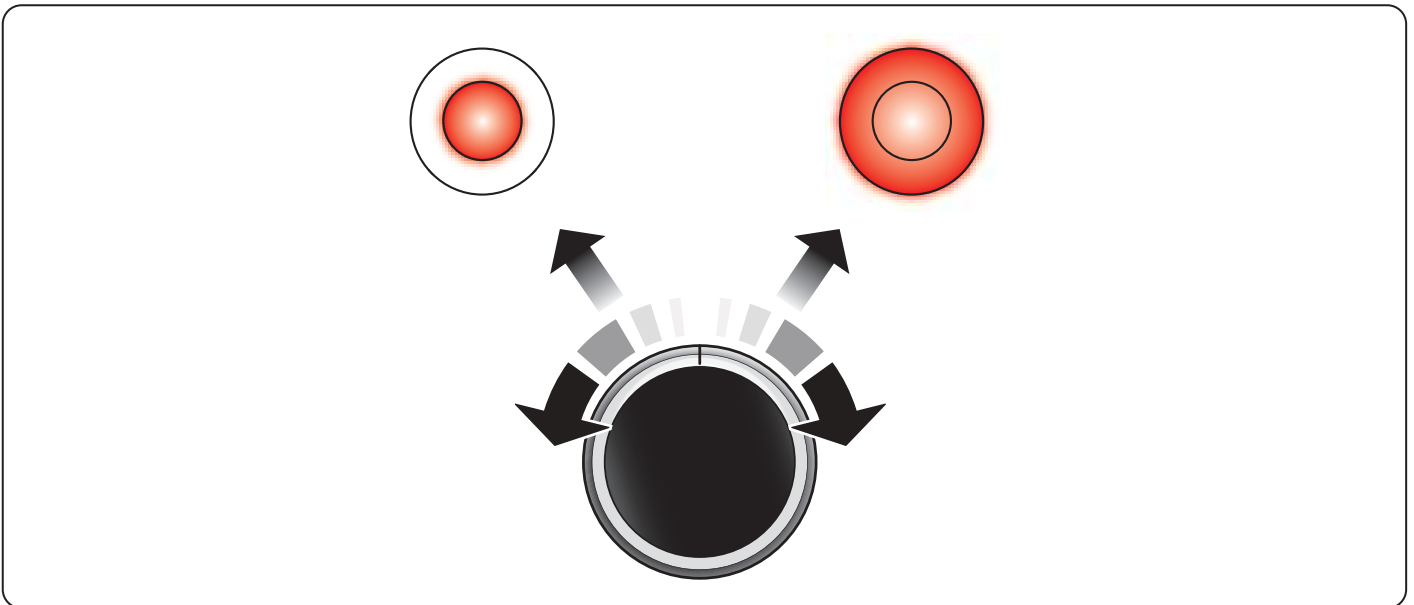

Zone chauffe-plats / Zone de cuisson - 6

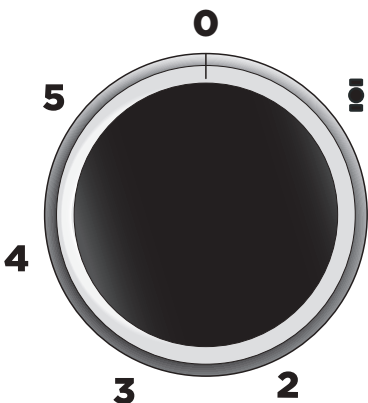

	1	2	3	4	5
Zone chauffe-plats complète	Chaleur faible	Chaleur moyenne - faire fondre du beurre	Chaleur moyenne - mijoter	Chaleur élevée	Chaleur très élevée

Entretien de l'appareil

⚠ Isoler l'alimentation électrique avant de nettoyer. Laisser la cuisinière refroidir.

Toutes les parties de la cuisinière peuvent être nettoyées à l'eau savonneuse – **mais veiller à ce que le surplus d'eau ne pénètre pas dans l'appareil.**

Pour une liste complète des recommandations de nettoyage pour chaque partie de la cuisinière, veuillez vous référer au mode d'emploi.

- Un nettoyage régulier est recommandé, pour un nettoyage simplifié, immédiatement nettoyer les saletés.
- Toutes les parties de la cuisinière peuvent être nettoyées avec de l'eau savonneuse et un chiffon doux ou des chiffons E-cloths.
- Pour les taches plus tenaces qui ne peuvent être éliminées avec de l'eau savonneuse et un chiffon doux, il est possible d'utiliser une crème nettoyante et une éponge en nylon.
- Les produits de nettoyage pour four adaptés à l'émail (tels que Oven Pride) peuvent être utilisés sur la base et l'arrière de la cavité du four, ainsi que sur d'autres surfaces émaillées. Ne laissez pas ces produits chimiques entrer en contact avec les éléments du four ou les revêtements catalytiques.
- N'utilisez pas de solvants pour peinture, de carbonate de sodium, de poudres biologiques, d'eau de Javel, de nettoyeurs blanchissants à base de chlore, d'abrasifs puissants ou de sel.
- N'utilisez pas de laine d'acier (paille de fer), d'éponges-grattoir pour nettoyer les fours ou tout autre matériel, car ils pourraient rayer la surface des cuisinières.
- Un grattoir peut être utilisé sur les plaques de cuisson à induction et en céramique pour éliminer les débris brûlés tenaces.

Pièces compatibles et non compatibles avec le lave-vaisselle

Pièces compatibles avec le lave-vaisselle	Pièces non compatibles avec le lave-vaisselle
Grilles de four	Glissières latérales
Grille pratique	Revêtements latéraux
Grille du chauffe-plat	Têtes des brûleurs
Lèchefrite	Glissières de four coulissantes
MeatTin (qui va sur le Handyrack)	Glissières de lèchefrite coulissantes
Bouchons des brûleurs	Cadrans de contrôle
Grils (à l'exception du gril à induction)	Gril à induction
Supports de casseroles	
Support pour wok	

Plats de test

Cuisson

Conformément à la norme EN60350-1

Cette table de cuisson a été produite pour les instituts de test afin de faciliter les tests des appareils.

* Préchauffé

** Fatless Sponge

Aliment	Plaque/Moule	Fonction du four	Niveau de la grille	Température	Temps
Sablé	Plaque de cuisson de 34cm x 34cm	Four ventilé	3	160°C*	12 minutes
Sablé	Plaque de cuisson de 34cm x 34cm	Four Conventionnel	3	170°C*	12 minutes
Sablés, 2 plaques	Plaque de cuisson de 34cm x 34cm	Four ventilé	2 et 4	160°C*	12 minutes
Sablés, 3 plaques	Plaque de cuisson de 34cm x 34cm	Four ventilé	1, 3 et 5	160°C*	12 minutes
Petits gâteaux	Plaque de cuisson de 34 cm x 34 cm - 16 gâteaux par plaque	Four ventilé	3	160°C*	30 minutes
Petits gâteaux	Plaque de cuisson de 34 cm x 34 cm - 16 gâteaux par plaque	Four Conventionnel	2	180°C*	30 minutes
Petits gâteaux, 2 étagères	Plaque de cuisson de 34 cm x 34 cm - 16 gâteaux par plaque	Four ventilé	2 et 4	160°C*	30 minutes
Petits gâteaux, 3 étagères	Plaque de cuisson de 34 cm x 34 cm - 16 gâteaux par plaque	Four ventilé	1, 3 et 5	160°C*	30 minutes
Éponge dégraissée**	Moule à charnière de 26 cm	Four ventilé	3	170°C*	35 minutes
Éponge dégraissée**	Moule à charnière de 26 cm	Four Conventionnel	2	180°C*	35 minutes
Éponge dégraissée**, 2 étagères	Moule à charnière de 26 cm	Four ventilé	2 et 4	160°C*	30 minutes
Tarte aux pommes	Moule à tarte de 20 cm	Four ventilé	3	200°C*	45 minutes
Tarte aux pommes	Moule à tarte de 20 cm	Four Conventionnel	2	210°C*	45 minutes
Tarte aux pommes, 2 étagères	Moule à tarte de 20 cm	Four ventilé	2 et 4	200°C*	45 minutes



Positions des grilles du four



Positions des grilles du grill

Grill * Préchauffé pendant 3 minutes **Retourner les aliments à mi-cuisson ou aux deux tiers de la cuisson

Aliment	Plaque/Moule	Niveau du grill	Position de la grille	Trivet Position	Temps
Toast	Poêle à griller et grille	3*	3	Highest	3-4 minutes**
Burgers de bœuf	Poêle à griller et grille	3*	3	Highest	15 minutes**

Remarques

Voordat u begint

- Zorg ervoor dat u **ALLE** verpakkingsmaterialen verwijderd heeft.
- Stel de klok op het juiste tijdstip van de dag in.
- Zorg dat de ruimte goed geventileerd wordt.
- Schakel de ovens in op 200 °C en laat het fornuis minstens een uur lang op deze temperatuur verwarmen om alle productiegeuren te laten verdwijnen.
- Schakel de grill in en laat deze 30 minuten actief met de grillpan in positie, volledig naar achteren geduwd en de grilldeur geopend.
- Veeg het emaille en de glazen oppervlakken af met een schone, pluisvrije, vochtige doek nadat het apparaat is afgekoeld.
- Inductiekookplaten vereisen bepaalde pannen voor optimale prestaties van de kookplaat. Zie panprestaties op pagina 35.
- Raadpleeg voor aanvullende informatie, waaronder de volledige gebruikershandleiding en technische en installatie-informatie het **Verdere ondersteuning** -gedeelte op pagina 79.

Indeling van uw apparaat

110 cm Modellen

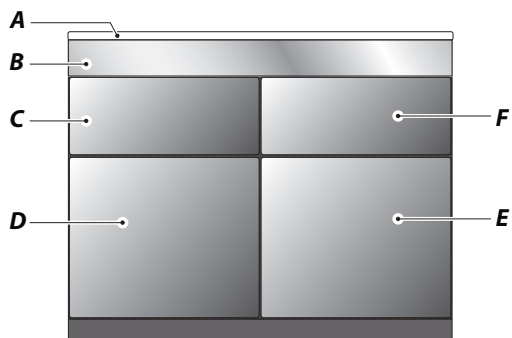
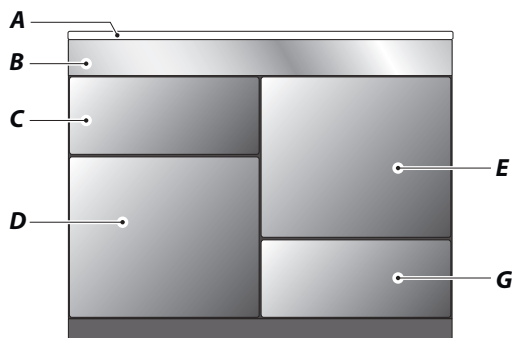

90 cm en 100 cm Modellen

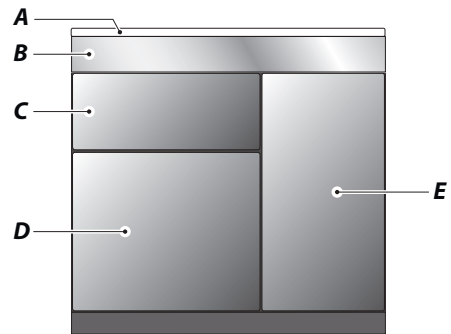

Enkele ovenruimte

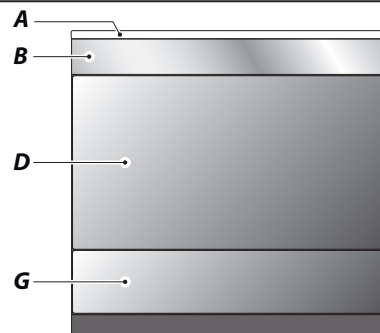

- A. Kookplaat**
- B. Bedieningspaneel**
- C. Grill**
- D. Multifunctionele/ Geventileerde oven**
- E. Geventileerde oven**
- F. Slow cooking-oven**
- G. Broodrijslade/Opberglade**

Geleverde accessoires

-  Geleverd met inductie-apparaten
-  Geleverd met gas-/elektra-apparaten
-  Geleverd met apparaat
-  Verkrijgbaar als een optionele extra

Alle afmetingen zijn in cm

	Wokring	Klassieke bakplaat	Deluxe bakplaat	Inductie-bakplaat	Grillpan	Telescopische geleiders	Plat rek Hoofdoven	Lang ovenrek	Bordenrek	Handyrack & ovenschaal
	90/100	110	alleen 110	90/100	110	90/100	110	90/100	110	90/100
Cotswold										
Camden										
Estate										
Classic										
Infusion Classic										
Professional +										
Infusion										
Toledo										
Longstock										
Classic Deluxe										
Estel Deluxe										
Leckford Deluxe										
Professional Deluxe										
Longstock Deluxe										
Encore Deluxe										
Edge Deluxe										
Arina Nexus										
Elise										
Stanley Supreme										

Geleverde accessoires - Enkele ruimte

- ▲ Geleverd met inductie-apparaten
- ◆ Geleverd met gas-/elektra-apparaten
- Geleverd met apparaat
- Verkrijgbaar als een optionele extra

	Wokring	Klassieke bakplaat	Inductie-bakplaat	Rek enkele ovenruimte	Grillpanrek	Grillpan	Grillonderzetter	Half rek	Energiebesparend-paneel
Classic Deluxe	◆		▲	■ x2	■ x1	■ x2	■ x2	■ x3	■ x1
Estel Deluxe	◆	◆	▲	■ x2	■ x1	■ x2	■ x2	■ x3	■ x1
Professional Deluxe	◆	◆	▲	■ x2	■ x1	■ x2	■ x2	■ x3	■ x1
Arina	◆		▲	■ x2	■ x1	■ x2	■ x2	■ x3	■ x1
Nexus	◆	◆	▲	■ x2	■ x1	■ x2	■ x2	■ x3	■ x1
Elise	◆		▲	■ x2	■ x1	■ x2	■ x2	■ x3	■ x1

Aan de slag

De klok instellen

Voordat de ovens kunnen werken, moet de klok worden ingesteld op het tijdstip van de dag.

Step. 1



Tik op de kloktoets [🕒] of druk gelijktijdig de toetsen [+] en [-] in om de klok in te stellen. Het decimaalpunt [.] gaat knipperen.

Step. 2

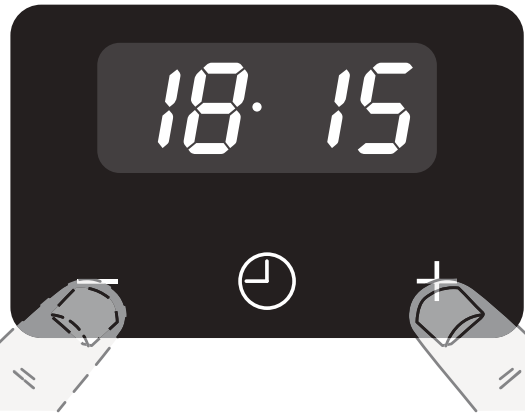

Gebruik de toetsen [+] of [-] om de juiste tijd in te stellen. Druk op de kloktoets [🕒] om te bevestigen.

Aanduidingen verlichting, oven en grill

De afbeeldingen naast elke draaiknop zijn ter illustratie en komen mogelijk niet overeen met die op uw apparaat.



Grill	peratuur- bediening LH-oven	Knop voor ltifunctionele oven (indien aanwezig)	Oven Verlichting	Rijslade voor brood	Slow cooking- oven	Temperatuur- bediening RH-oven

Aanduiding verlichting en oven - Enkele ovenruimte

De afbeeldingen naast elke draaiknop zijn ter illustratie en komen mogelijk niet overeen met die op uw apparaat.

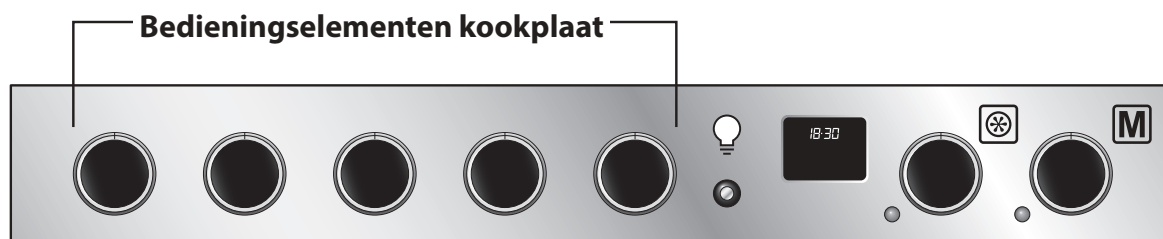

		
Temperatuur- bediening	Keuzeknop ultifunctionele oven	Oven Verlichting

De grill

Bediening van de grill

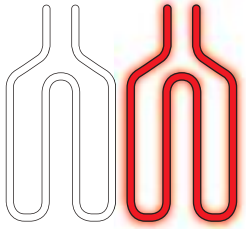

Het halfelement aanzetten

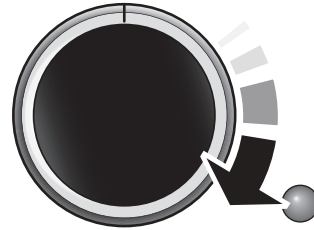

Beide elementen aanzetten

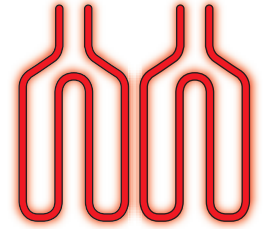

Hoogte-afstelling grillonderzetter

A
Dichtst bij het element

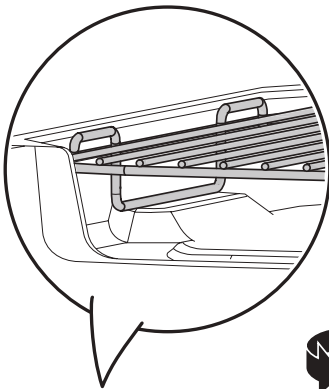

B
Middelhoog

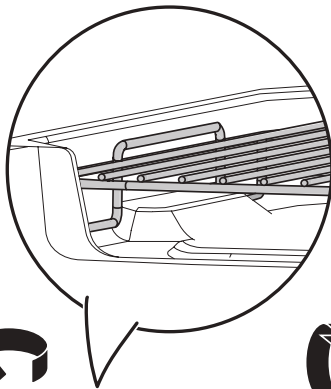

C
Verst van het element

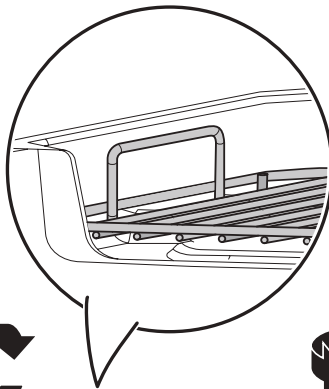

D
Middellaag

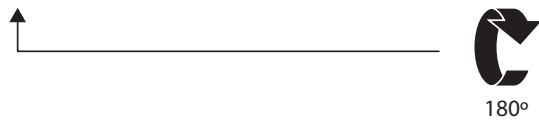
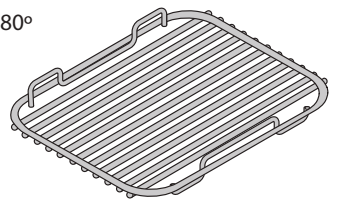
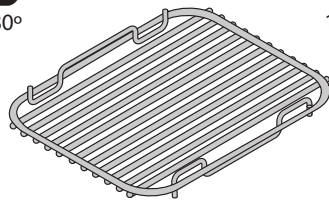
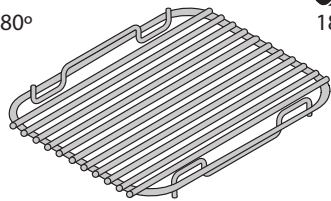
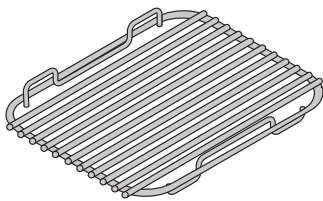
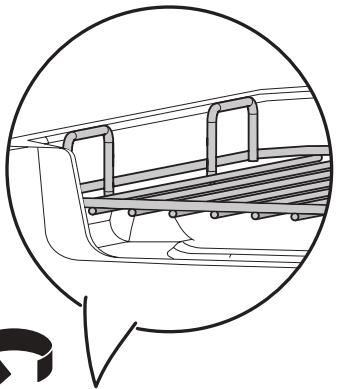

180°

Monteren telescopisch grillgeleider

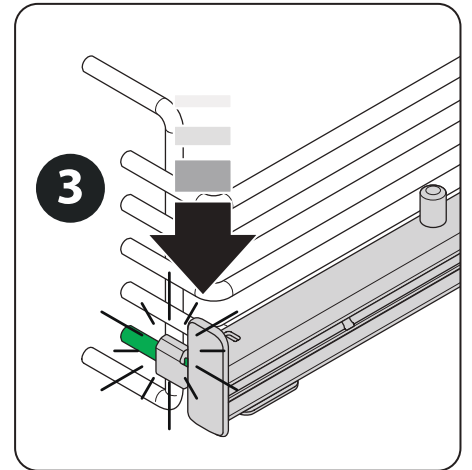
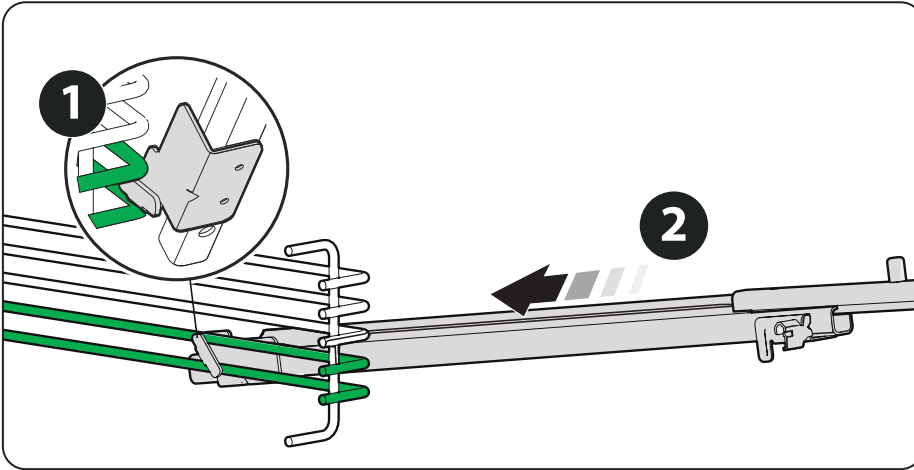

Monteren/verwijderen grillpan

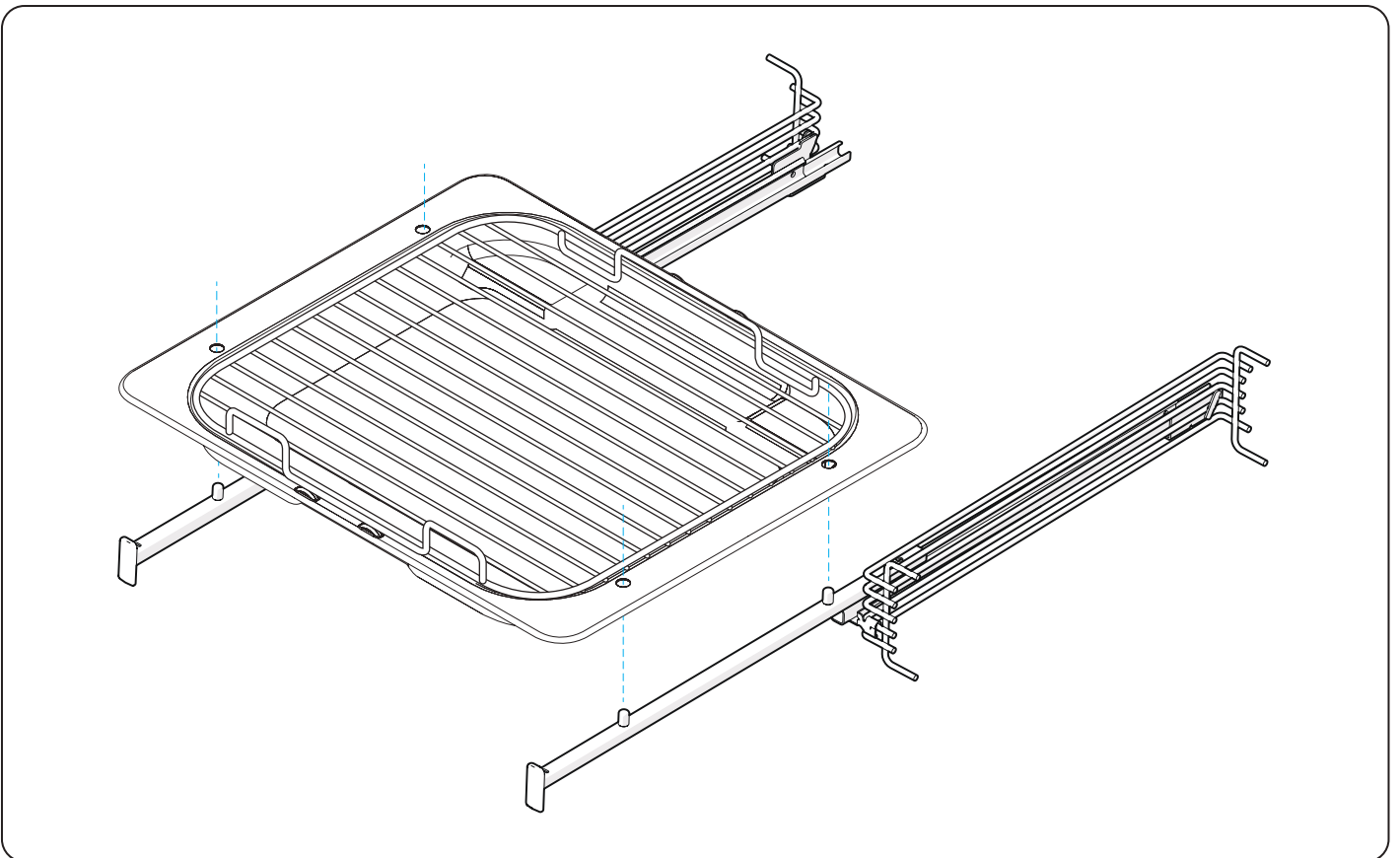

Posities van de grillpan

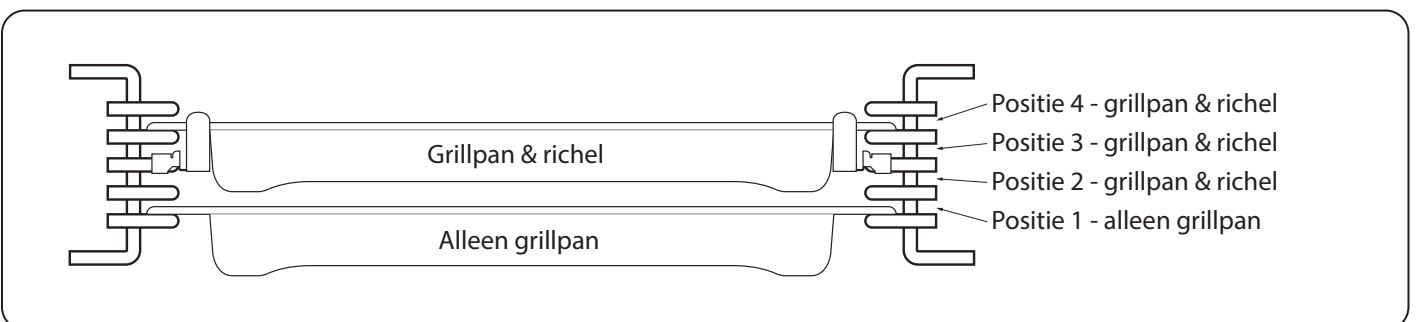

De ovens

Symbolen multifunctionele oven

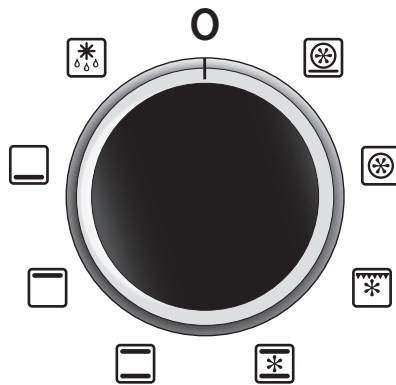

Duo	Heteluchtoven	Grillen met ventilator	Ventilatorondersteuning	Conventioneel	Bruin maken	Onderwarmte	Ontdooien

Raadpleeg de volledige gebruikershandleiding voor meer informatie over deze functies.

Bediening multifunctionele oven

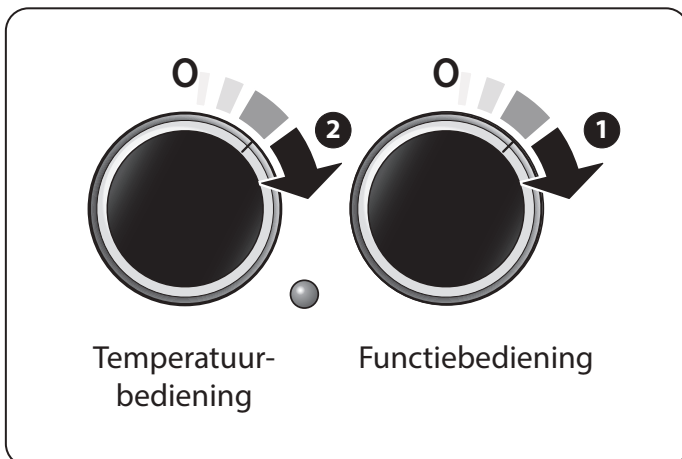

Bediening heteluchtoven

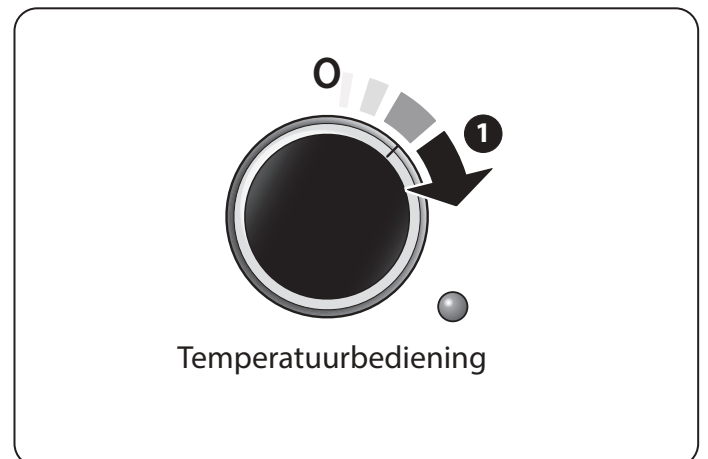

Monteren overrek

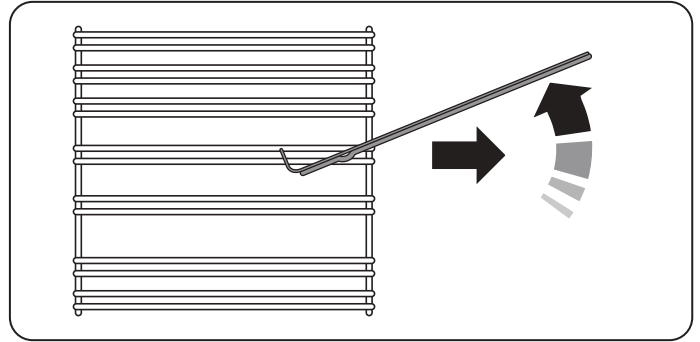
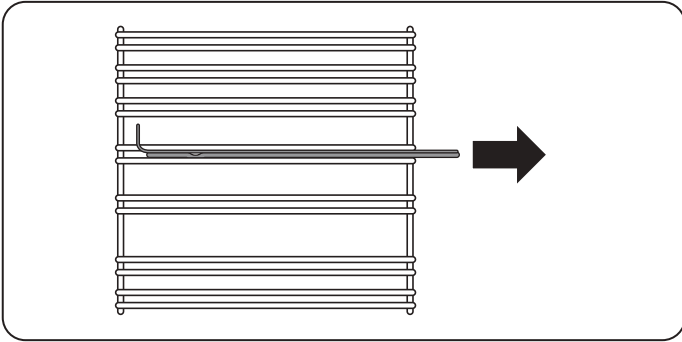

Monteren telescopisch overrek

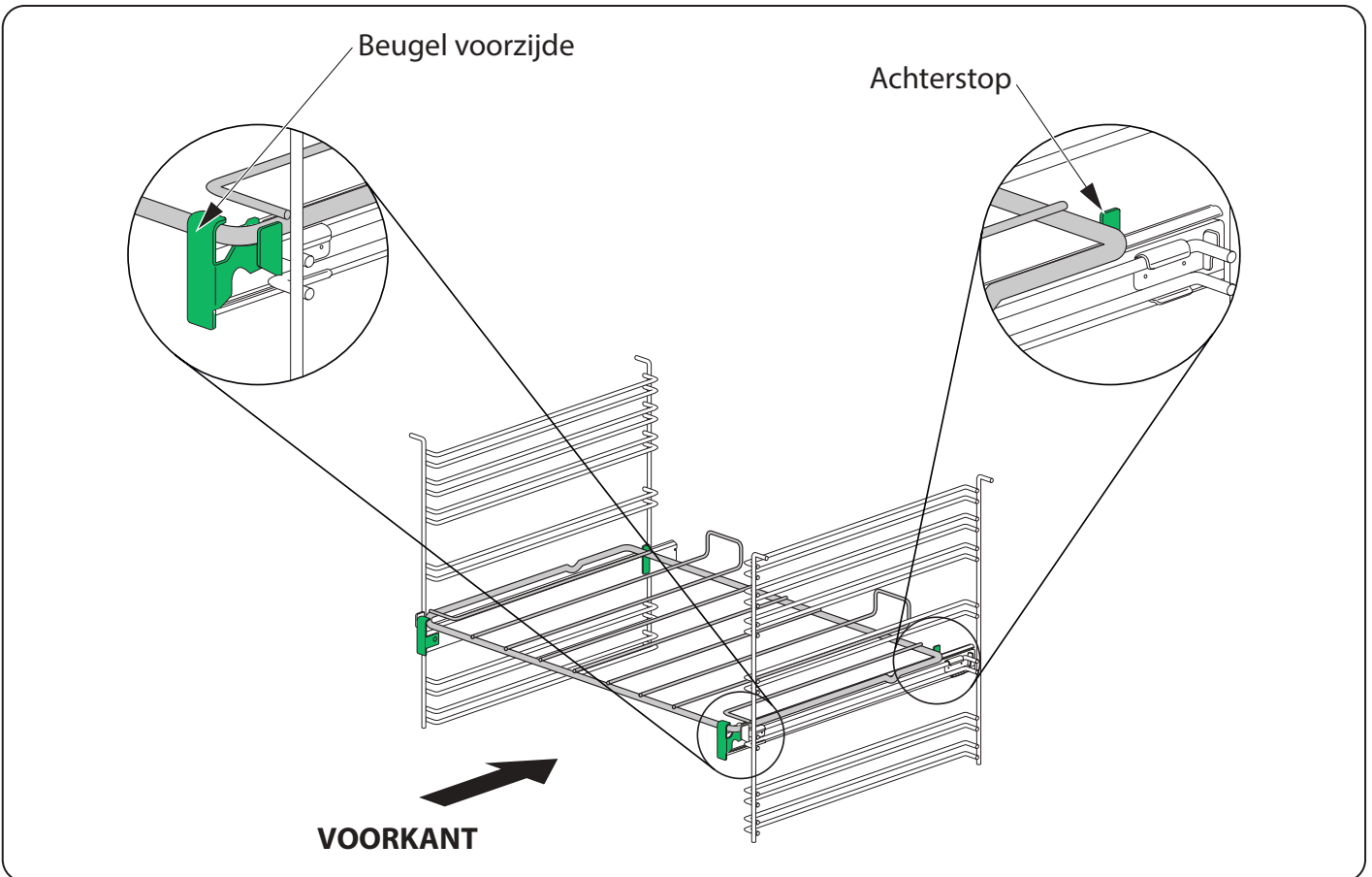
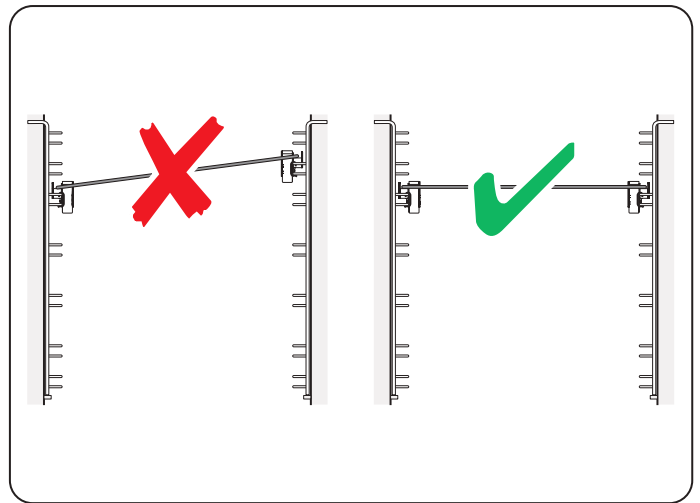
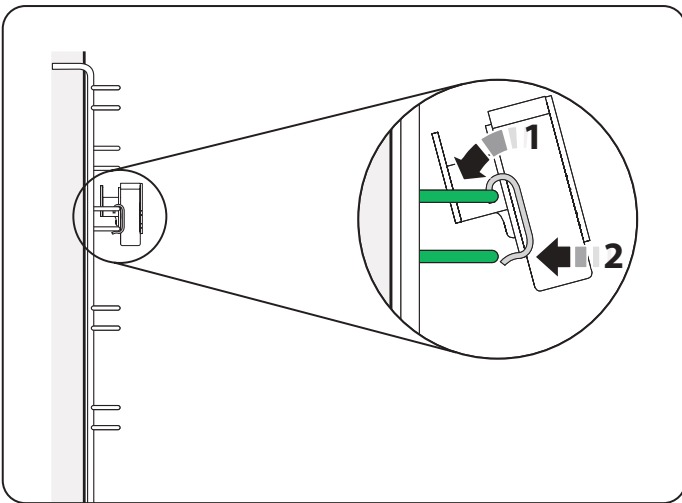

Enkele ovenruimte - Energiebesparingspaneel

Energiebesparingspaneel plaatsen

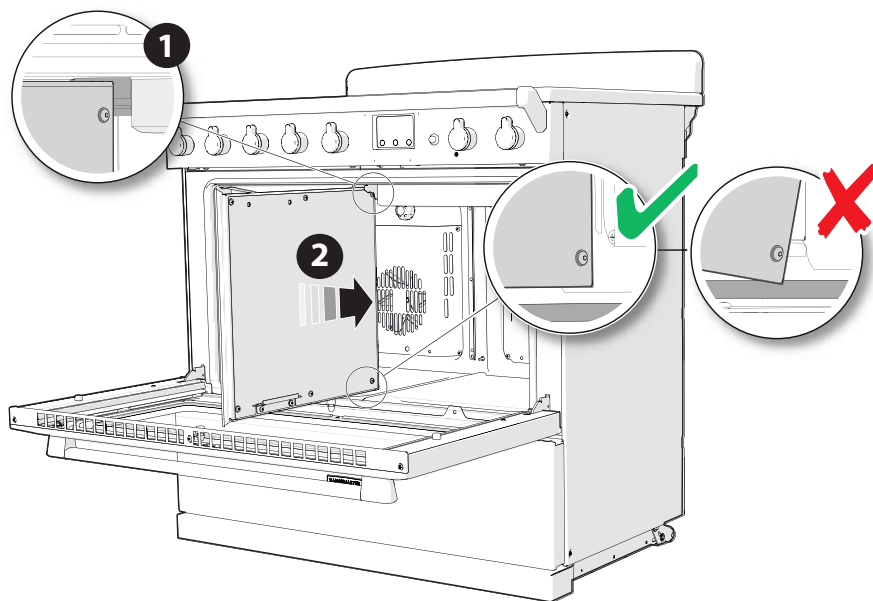

Stop de rubberen afdichting langs de binnenste glasrand.

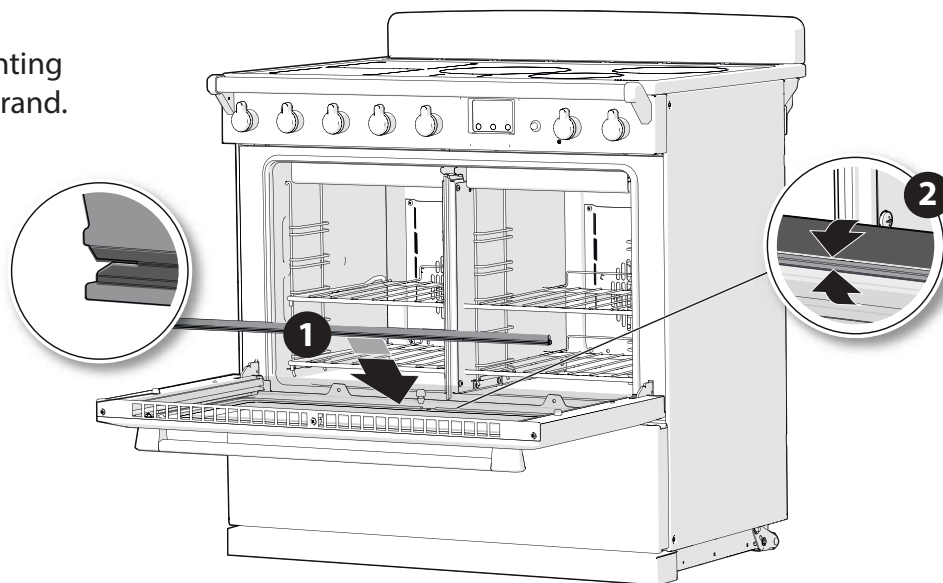

Energiebesparingspaneel

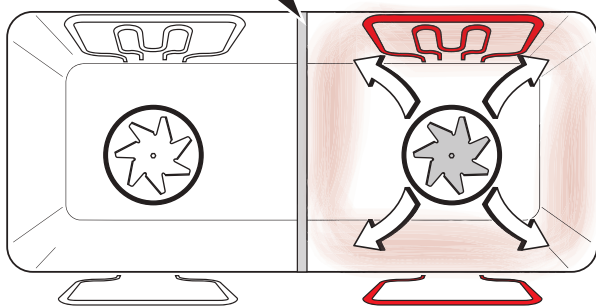

Energiebesparingspaneel verwijderen

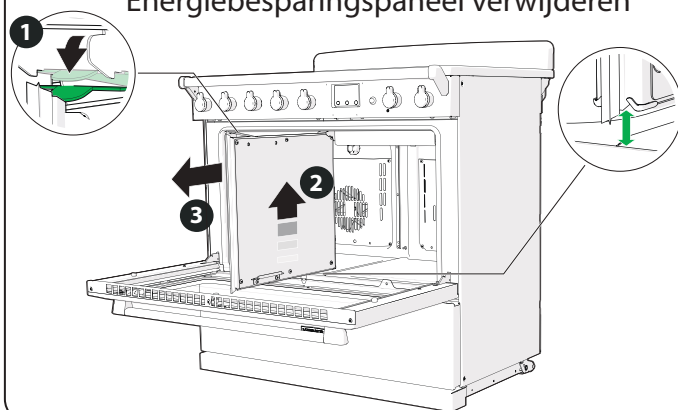

Kookplaat - indeling en bediening

Dubbele brandstof

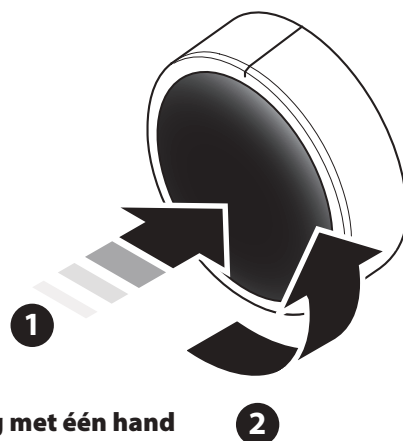
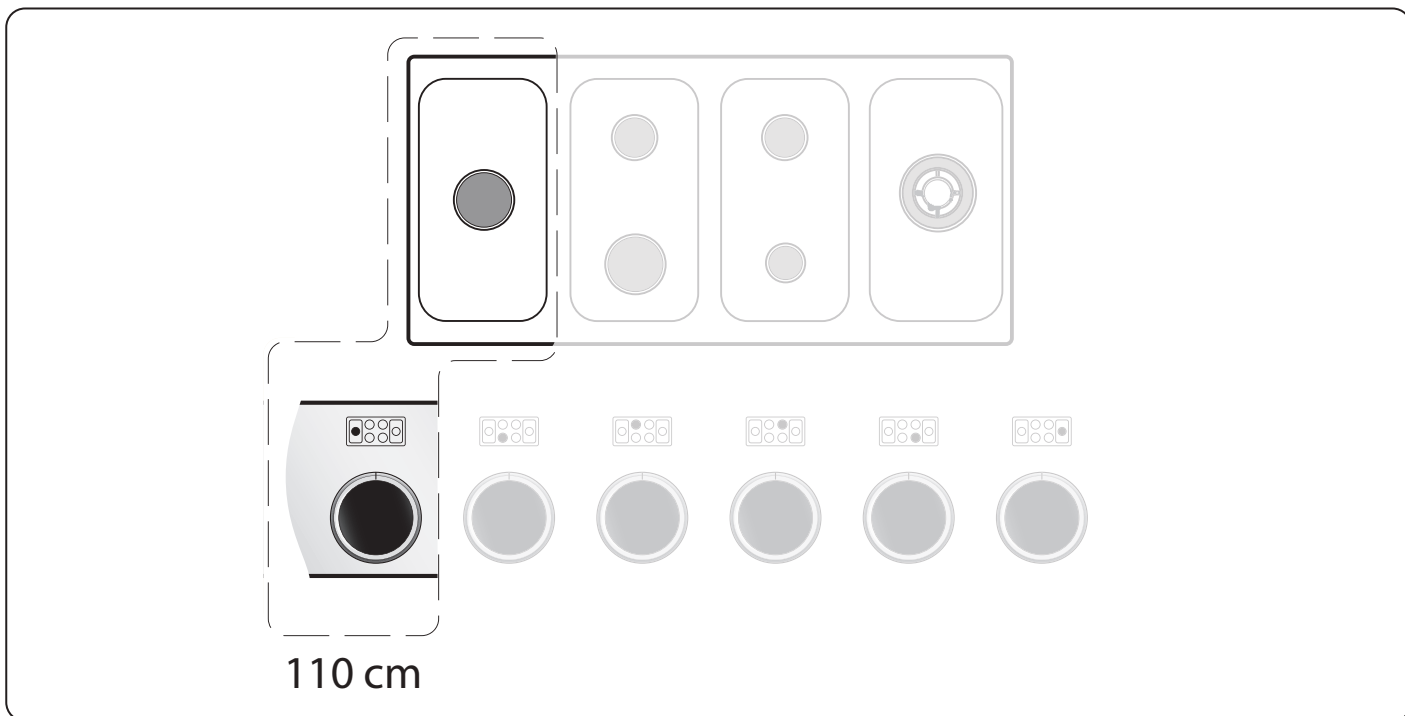

110 cm Modellen met meerdere zones

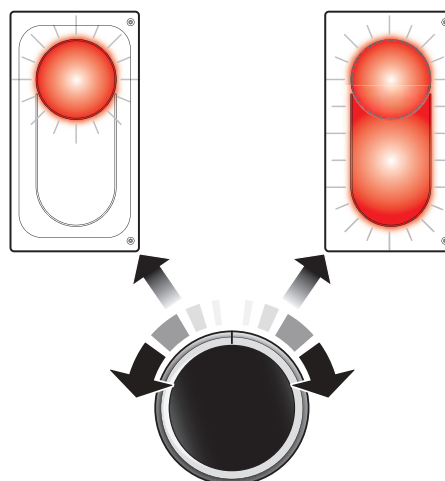
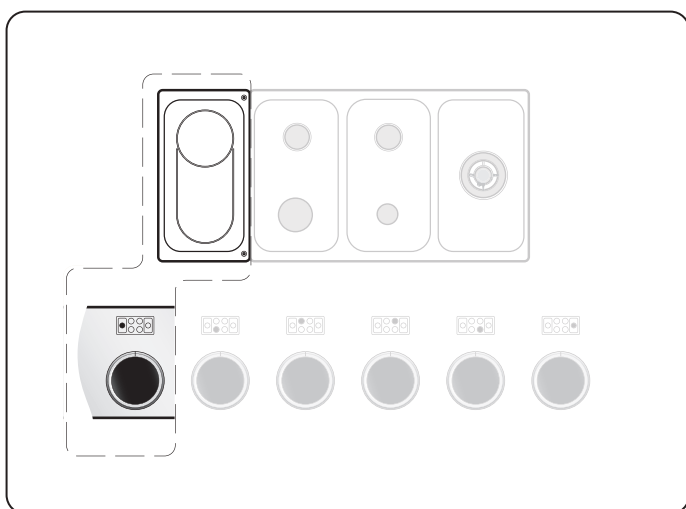

Kookplaat - indeling en bediening

Inductie för Kitchener

Controle van panprestaties

Gebruik een 1,85 kW-zone (raadpleeg de handleiding voor nominale waarden van elke zone).

Vul een pan zonder deksel met 1/2 liter water op kamertemperatuur (de diameter van de pan mag niet groter zijn dan de buitenste cirkel van de zone).

Inductie-indeling

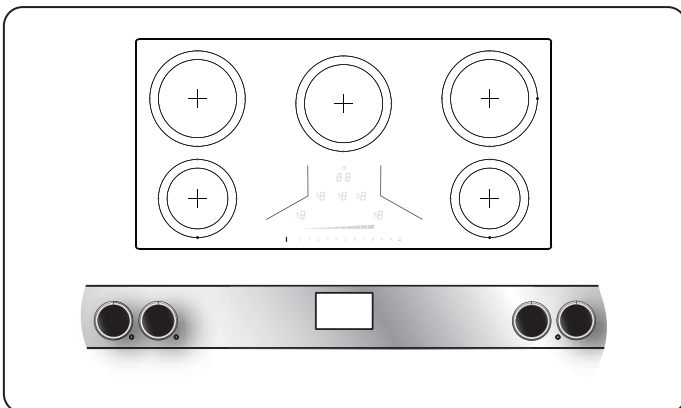

Gebruik de zone op vermogensniveau 9.

Het water zou binnen 3½ minuten moeten koken.

Kooktijden buiten deze tijdsduur wijzen erop dat de constructie van de pan niet ideaal is om de beste prestaties te leveren en tot voortijdig defect van onderdelen kan leiden.

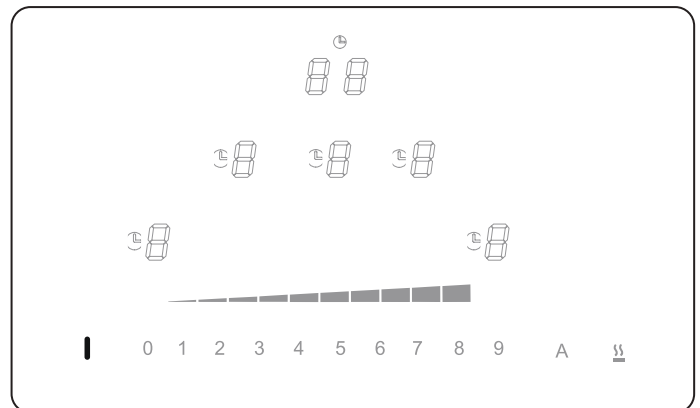

Inductiesymbolen

Om de functies te selecteren, drukt u op de desbetreffende symbolen op het schermpaneel.

Bedieningsvolgorde [Drukken Drukken en vegen]	Schermweergave	Functie	Schermweergave	Functie
	CL	• Zet aan en timer gereed	0...9 0 1 2 3 4 5 6 7 8 9	• Temperatuurinstellingen - Niveau 1 tot 9
0 → ss	- ss knippert 0 1	• Instellingen voor lage temperatuur - Alleen niveau 1	P	• Instelling vermogensboost
0 → A	A	• Automatisch opwarmen (indien beschikbaar)	H	• Restwarmte-indicatielampje
CL → 0 → 0 1 2 3	99	• Timerinstelling, met een maximum van 99 minuten. • 1-minuut timer; aftellen vanaf 59 seconden.	U	• Geen pan indicatie
			0	• Pannetje/Koekenpan gedetecteerd op de betreffende zone
			E #	• Verzoek om serviceondersteuning
			ER	
			EH	
			Er	

Kookplaat - indeling en bediening

Inductie för Professional+ / Professional Deluxe

Controle van potprestaties

1. Zet de pot op de betreffende kookzones om te beoordelen.
2. Druk op en druk vervolgens 3 keer op .
3. Druk op .

De zone begint de pot te beoordelen en de knipperende sequentie van .

Wanneer de controle is voltooid, toont het display:-
Graad 3 [] betekent Uitstekend; optimale kookprestaties.

Graad 2 [] betekent Gemiddeld; verminderde kookprestaties.

Graad 1 [] betekent Slecht.

Inductie-indeling

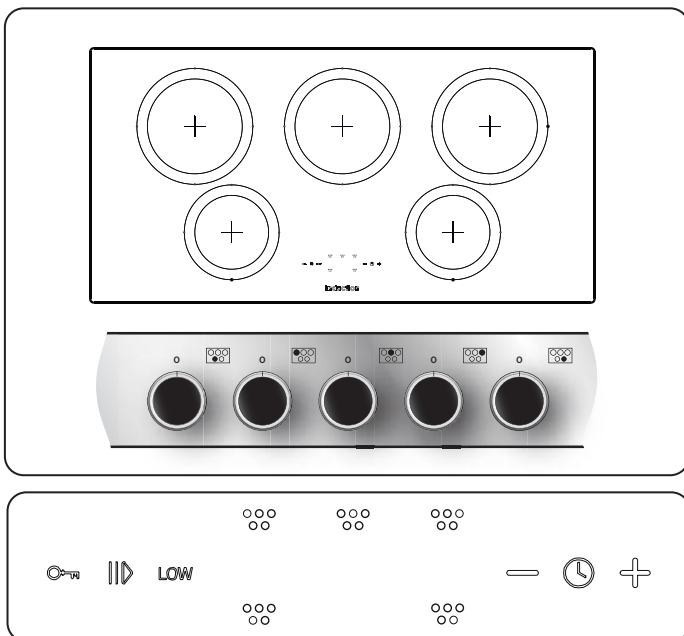

Indeling met overbruggingszone

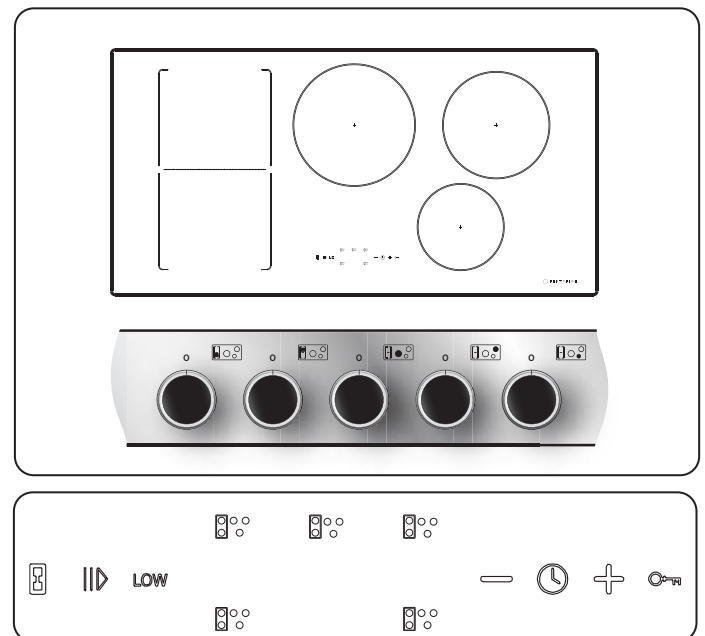

Inductiesymbolen

Om de functies te selecteren, drukt u op de desbetreffende symbolen op het schermpaneel.

Volgorde van de operatie [Druk op]	Schermweergave	Functie
		• Kindersicherung
		• Overbruggingszone activeren/deactiveren
		• Pauzeer alle kookzones
→	TIMER	• Timerinstelling, tot maximaal 99 minuten
LOW →	LOW	• Lage temperatuurinstellingen - alleen Niveau 1 tot 3

Schermweergave	Functie
	• Temperatuurinstellingen - Niveau 1 tot 9
	• Instelling vermogensboost
	• Restwarmte-indicatielampje
	• Verzoek om serviceondersteuning
	• Geen pan indicatie

Kookplaat - indeling en bediening

Inductie

Inductie-indeling

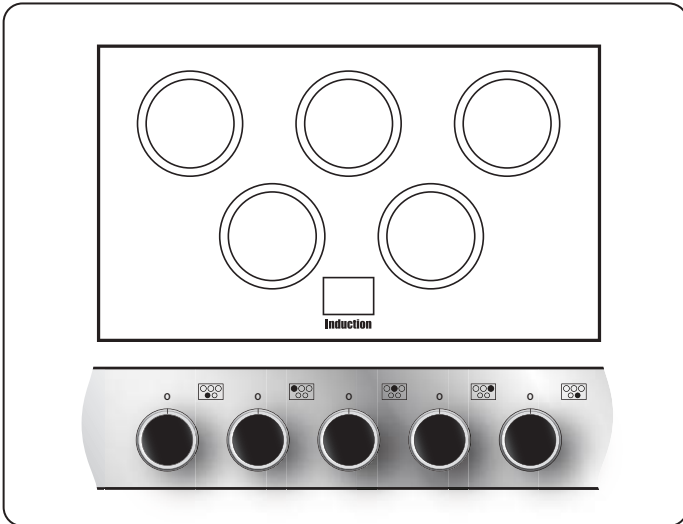

Indeling met overbruggingszone

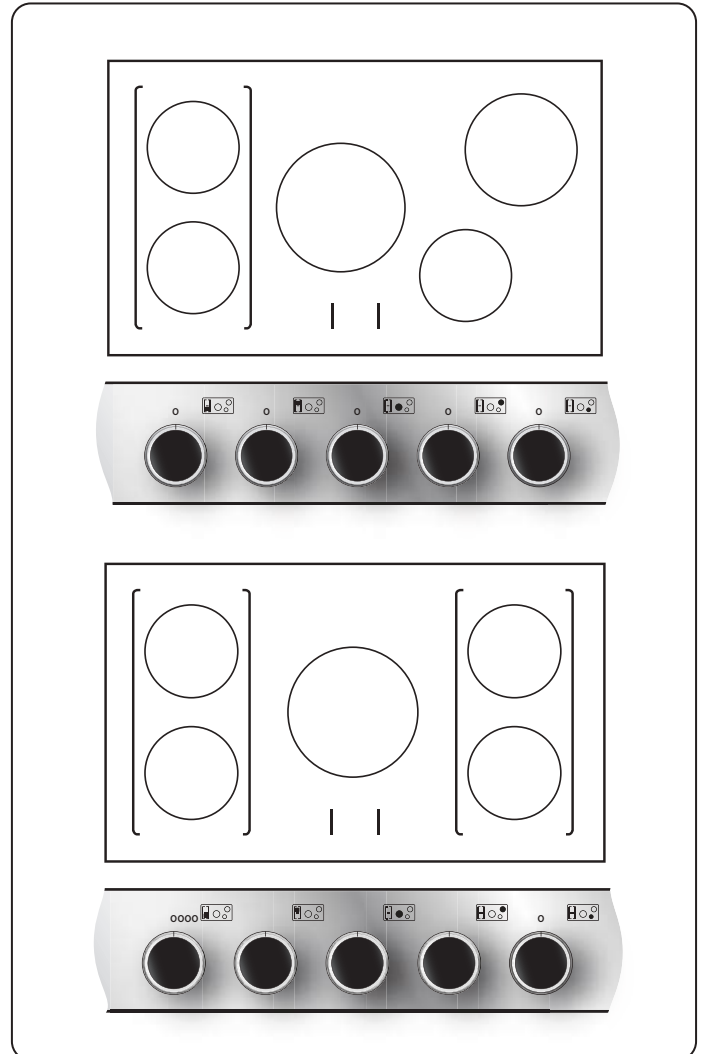

Controle van panprestaties

Gebruik een 1,85 kW-zone (raadpleeg de handleiding voor nominale waarden van elke zone).

Vul een pan zonder deksel met 1/2 liter water op kamertemperatuur (de diameter van de pan mag niet groter zijn dan de buitenste cirkel van de zone).

Gebruik de zone op vermogensniveau 9.







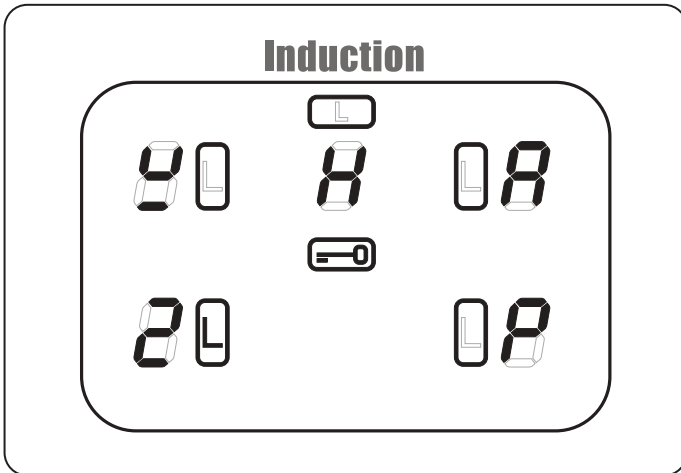

Het water zou binnen 3½ minuten moeten koken.

Kooktijden buiten deze tijdsduur wijzen erop dat de constructie van de pan niet ideaal is om de beste prestaties te leveren en tot voortijdig defect van onderdelen kan leiden.

Kookplaat - indeling en bediening

Inductiesymbolen



U	Geen pan indicatie
H	Restwarmte-indicatielampje
A	Automatisch opwarmen - indien beschikbaar
	Kindersicherung
	Instelling lage temperatuur 1 - Smelten:  2 - Suddereren: 
	Instelling lage temperatuur 1 - Smelten:  2 - Blijf warm:  3 - Suddereren: 
1...9	Temperatuurinstellingen - Niveau 1 tot 9
P	Instelling vermogensboost
E 2	De temperatuur van de pan of het glas is te hoog. Laat het systeem afkoelen.
E 3	Ongeschikt kookgerei; voer de pannentest uit of probeer ander kookgerei.
Er-E	Handmatige reset uitvoeren. Neem contact op met de klantenservice als het probleem aanhoudt.

Kookplaat - indeling en bediening

Keramisch

110 cm Indeling

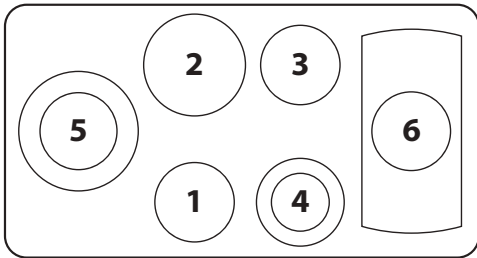

90 cm en 100 cm Indeling

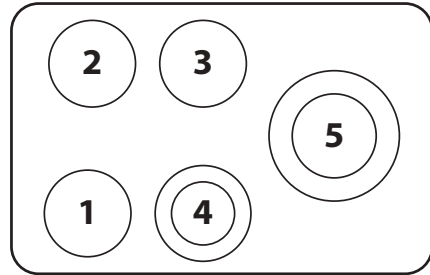

Dubbel element kookplaatposities - 4 en 5

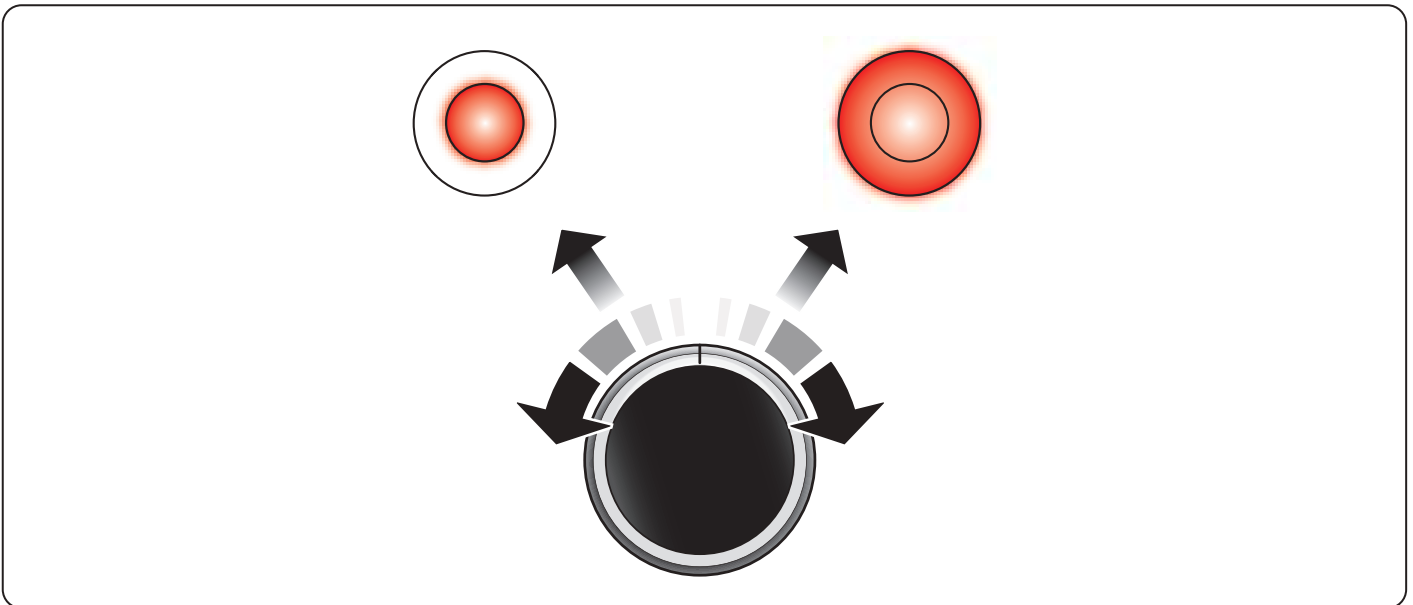

Verwarmingszone/Kookzone - 6

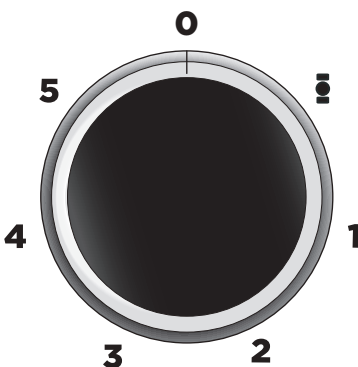

	1	2	3	4	5
Volledige verwarmingszone	Lage verwarmingsstand	Gemiddelde verwarming - boter smelten	Gemiddelde verwarming - sudderen	Hoge verwarmingsstand	Zeer hoge verwarmingsstand

Verzorging van het apparaat

⚠ Schakel de stroomtoevoer uit voordat u een grondige schoonmaak uitvoert. Laat het fornuis afkoelen.

Alle onderdelen van het fornuis kunnen worden schoongemaakt met warm zeepwater - **Zorg echter dat er geen overtollig water in het apparaat sijpelt.**

Raadpleeg de gebruikershandleiding voor een volledige lijst met aanbevolen schoonmaakbeurten voor elk onderdeel van het fornuis.

- Regelmatig schoonmaken wordt aanbevolen. Veeg gemorste vloeistof onmiddellijk op om het schoonmaken te vergemakkelijken.
- Alle onderdelen van het fornuis kunnen worden schoongemaakt met warm zeepwater en een zachte doek of e-doekjes.
- Crèmereiniger en nylon schuursponsjes kunnen worden gebruikt voor hardnekkiger vlekken die niet met zeepwater of met een zachte doek kunnen worden verwijderd.
- Een speciale ovenreiniger die geschikt is voor emaille (zoals Auro) kan gebruikt worden op de bodem en achterkant van de ovenruimte en andere oppervlakken van emaille. Laat deze chemicaliën niet in contact komen met de ovenelementen of katalytische voeringen.
- Gebruik geen verfoplosmiddelen, soda, biologische poeders, bleekmiddel, chloorbleekmiddelen, grove schuurmiddelen of zout.
- Gebruik geen staalwol, ovenpads of andere materialen, omdat deze krassen kunnen veroorzaken op het oppervlak van het fornuis.
- Voor hardnekkig, aangebrand vuil kan op inductiekookplaten en keramische kookplaten een kookplaatschraper worden gebruikt.

Vaatwasmachinebestendige en niet-vaatwasmachinebestendige onderdelen

Vaatwasmachinebestendige onderdelen	Niet-vaatwasmachinebestendige onderdelen
Ovenroosters	Zijgeleiders
Handyrack	Zijbekleding
Bordverwarmingsrek	Branderkoppen
Grillpan	Uittrekbare ovengeleiders
MeatTin (die op het Handyrack gaat)	Uittrekbare grillgeleiders
Branderkappen	Draaiknoppen
Bakplaten (behalve inductiebakplaat)	Inductiebakplaat
Pannendragers	
Wokring	

Testgerechten

Bakken

In overeenstemming met EN60350-1

Deze kooktabel is gemaakt voor testinstituten om het testen van apparaten te vergemakkelijken.

* Voorverwarmd

** Fatless Sponge

Voedsel	Dienblad / Blik	Ovenfunctie	Roosterhoogte	Temperatuur	Tijd
Zandkoek	34cm x 34cm Bakpapier	Heteluchtoven	3	160°C*	12 minuten
Zandkoek	34cm x 34cm Bakpapier	Conventionele oven	3	170°C*	12 minuten
Zandkoek, 2 bakjes	34cm x 34cm Bakpapier	Heteluchtoven	2 & 4	160°C*	12 minuten
Zandkoek, 3 bakjes	34cm x 34cm Bakpapier	Heteluchtoven	1, 3 & 5	160°C*	12 minuten
Kleine taarten	Bakplaat van 34 cm x 34 cm - 16 cakejes per bakplaat	Heteluchtoven	3	160°C*	30 minuten
Kleine taarten	Bakplaat van 34 cm x 34 cm - 16 cakejes per bakplaat	Conventionele oven	2	180°C*	30 minuten
Kleine taarten, 2 bakjes	Bakplaat van 34 cm x 34 cm - 16 cakejes per bakplaat	Heteluchtoven	2 & 4	160°C*	30 minuten
Kleine taarten, 3 bakjes	Bakplaat van 34 cm x 34 cm - 16 cakejes per bakplaat	Heteluchtoven	1, 3 & 5	160°C*	30 minuten
Vetvrije spons**	Springvorm van 26 cm	Heteluchtoven	3	170°C*	35 minuten
Vetvrije spons**	Springvorm van 26 cm	Conventionele oven	2	180°C*	35 minuten
Vetvrije spons**, 2 roosters	Springvorm van 26 cm	Heteluchtoven	2 & 4	160°C*	30 minuten
Appeltaart	Taartvorm van 20 cm	Heteluchtoven	3	200°C*	45 minuten
Appeltaart	Taartvorm van 20 cm	Conventionele oven	2	210°C*	45 minuten
Appeltaart, 2 roosters	Taartvorm van 20 cm	Heteluchtoven	2 & 4	200°C*	45 minuten

Grill * Voorverwarmd gedurende 3 minuten **Keer het voedsel tussen de helft en tweede van de kooktijd om

Food	Dienblad / Blik	Grillniveau	Rekpositie	Positie onderzetter	Tijd
Toast	Grillpan en onderzetter	3*	3	Hoogste	3 - 4 minuten**
Rundvleesburgers	Grillpan en onderzetter	3*	3	Hoogste	15 minuten**



Ovenrekposities

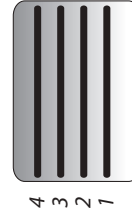

Posities van grillplanken

Opmerking

Vor der Inbetriebnahme

- Stellen Sie sicher, dass **ALLE** Verpackungsmaterialien entfernt wurden.
- Stellen Sie die korrekte Uhrzeit ein.
- Achten Sie darauf, dass der Raum gut belüftet ist.
- Stellen Sie alle Öfen auf 200 °C ein und lassen Sie sie mindestens eine Stunde lang laufen, um herstellungsbedingte Gerüche zu beseitigen.
- Stellen Sie den Grill ein und lassen Sie ihn 30 Minuten lang laufen. Schieben Sie zuvor die Grillpfanne vollständig ein und öffnen Sie die Grilltür.
- Nachdem das Gerät abgekühlt ist, wischen Sie die Emaille- und Glasflächen mit einem sauberen, fusselfreien, feuchten Tuch ab.
- Für die optimale Leistung von Induktionskochfeldern ist spezielles Kochgeschirr erforderlich. Siehe Leistung des Kochgeschirrs auf Seite 54.
- Zusätzliche Informationen, u. a. die komplette Bedienungsanleitung, technische Angaben und die Installationsanleitung siehe Abschnitt **Weitere Unterstützung** auf Seite 79.

Übersicht Ihres Geräts

Modelle 110 cm

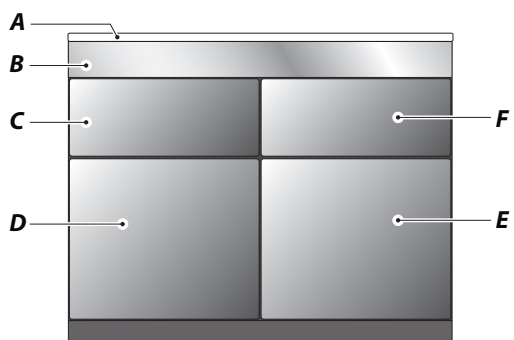
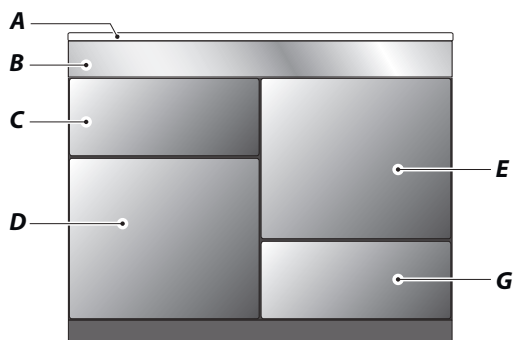

- A. Kochfeld**
- B. Bedienfeld**
- C. Grill**
- D. Multifunktions-/Umluftofen**
- E. Umluftofen**
- F. Niedrigtemperatur-Ofen**
- G. Brotgärfach/Ablagefach**

Modelle 90 cm und 100 cm

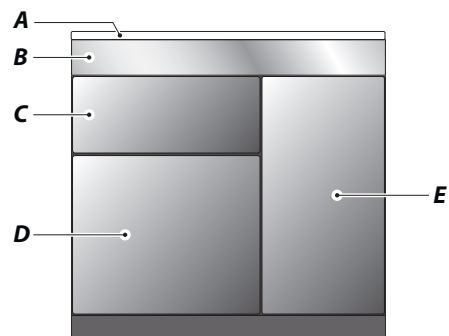

Einzelgarraum

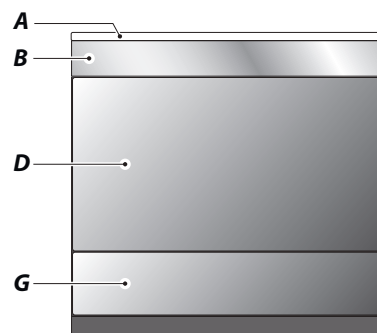

Im Lieferumfang enthaltenes Zubehör

- ▲ Im Lieferumfang der Induktionsgeräte enthalten
 - ◆ Im Lieferumfang der Dualbrennstoff-Geräte enthalten
 - Im Lieferumfang des Geräts enthalten
 - Als Sonderausstattung erhältlich
- Alle Größenangaben in Zentimeter

	90/100	110	nur 110	90/100	110	90/100	110	90/100	110	90/100	110	90/100	110	90/100	110	90/100	110	90/100	110
	Wok-Ständer	Classic-Grillplatte	Deluxe-Grillplatte	Induktions-grillplatte	Grillpfanne ■ Standard ■ Teleskop	Teleskop-schienen	Flacher Rost Hauptofen	Rost für großen Ofen	Tellerrost	Handyrack & Blech									
Cotswold	●	●			▲		■ x 2	■ x 4	●										
Camden	●	●			▲		■ x 2	■ x 4	●										
Estate	●	◆			■	■ x 1	■ x 2	■ x 4	●										
Classic	●	◆			■	■ x 1	■ x 2	■ x 4	●										
Infusion Classic	●	◆			■	■ x 1	■ x 2	■ x 4	●										
Professional +	●	◆			■	■ x 1	■ x 2	■ x 4	●										
Infusion	●	◆			■	■ x 1	■ x 2	■ x 4	●										
Toledo	●	◆			■	■ x 1	■ x 2	■ x 4	●										
Longstock	●	◆			■	■ x 1	■ x 2	■ x 4	●										
Classic Deluxe	◆	◆	◆	▲	■	■ x 1	■ x 2	■ x 4	■	■									
Estel Deluxe	◆	◆	◆	▲	■	■ x 1	■ x 2	■ x 4	■	■									
Leckford Deluxe	◆	◆	◆	▲	■	■ x 1	■ x 2	■ x 4	■	■									
Professional Deluxe	◆	◆	◆	▲	■	■ x 1	■ x 2	■ x 4	■	■									
Longstock Deluxe	◆	◆	◆	▲	■	■ x 1	■ x 2	■ x 4	■	■									
Encore Deluxe	◆	◆	◆	▲	■	■ x 1	■ x 2	■ x 4	■	■									
Edge Deluxe	◆	◆	◆	▲	■	■ x 1	■ x 2	■ x 4	■	■									
Arina Nexus	◆	◆	◆	▲	■	■ x 2	■ x 4	■ x 4	■	■									
Elise	◆	◆	◆	▲	■	■ x 2	■ x 4	■ x 4	■	■									
Stanley Supreme	◆	◆	◆	▲	■	■ x 2	■ x 4	■ x 4	■	■									

Im Lieferumfang enthaltenes Zubehör – Einzelgarraum

- ▲ Im Lieferumfang der Induktionsgeräte enthalten
- ◆ Im Lieferumfang der Dualbrennstoff-Geräte enthalten
- Im Lieferumfang des Geräts enthalten
- Als Sonderausstattung erhältlich

	Wok-Ständer	Classic-Grillplatte	Induktions-grillplatte	Rost für Einzelgarraum	Grillpfannen-Auflagerahmen	Grillpfanne	Grillaufsatz	Halber Rost	Energiesparplatte

Classic Deluxe	◆	◆	▲	■ x 2	■ x 1	■ x 2	■ x 2	■ x 3	■ x 1
Estel Deluxe	◆	◆	▲	■ x 2	■ x 1	■ x 2	■ x 2	■ x 3	■ x 1
Professional Deluxe	◆	◆	▲	■ x 2	■ x 1	■ x 2	■ x 2	■ x 3	■ x 1
Arina	◆	◆	▲	■ x 2	■ x 1	■ x 2	■ x 2	■ x 3	■ x 1
Nexus	◆	◆	▲	■ x 2	■ x 1	■ x 2	■ x 2	■ x 3	■ x 1
Elise	◆	◆	▲	■ x 2	■ x 1	■ x 2	■ x 2	■ x 3	■ x 1

Erste Schritte

Einstellen der Uhr

Bevor die Öfen verwendet werden können, muss die Uhrzeit eingestellt sein.

Step. 1



Tippen Sie auf die Uhr-Taste [⌚] oder verwenden Sie die Tasten [+] und [-] gleichzeitig, um den Uhrzeit-Einstellungsmodus zu aktivieren.

Step. 2

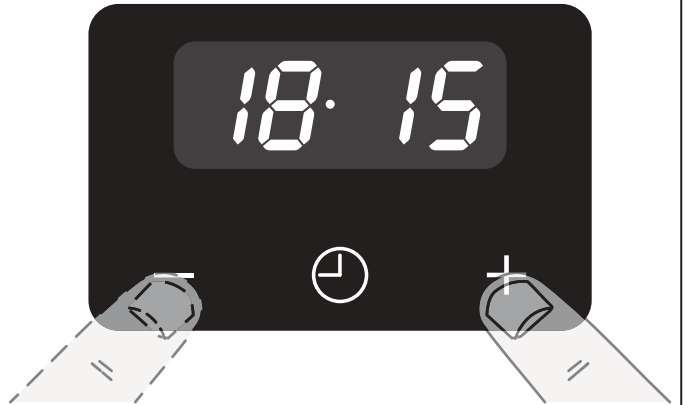

Verwenden Sie die Taste [+] oder [-] zum Einstellen der korrekten Uhrzeit.

Identifizierung von Leuchten, Ofen und Grill

Die Abbildungen neben den einzelnen Drehreglern sind repräsentativ und entsprechen möglicherweise nicht denen auf Ihrem Gerät.

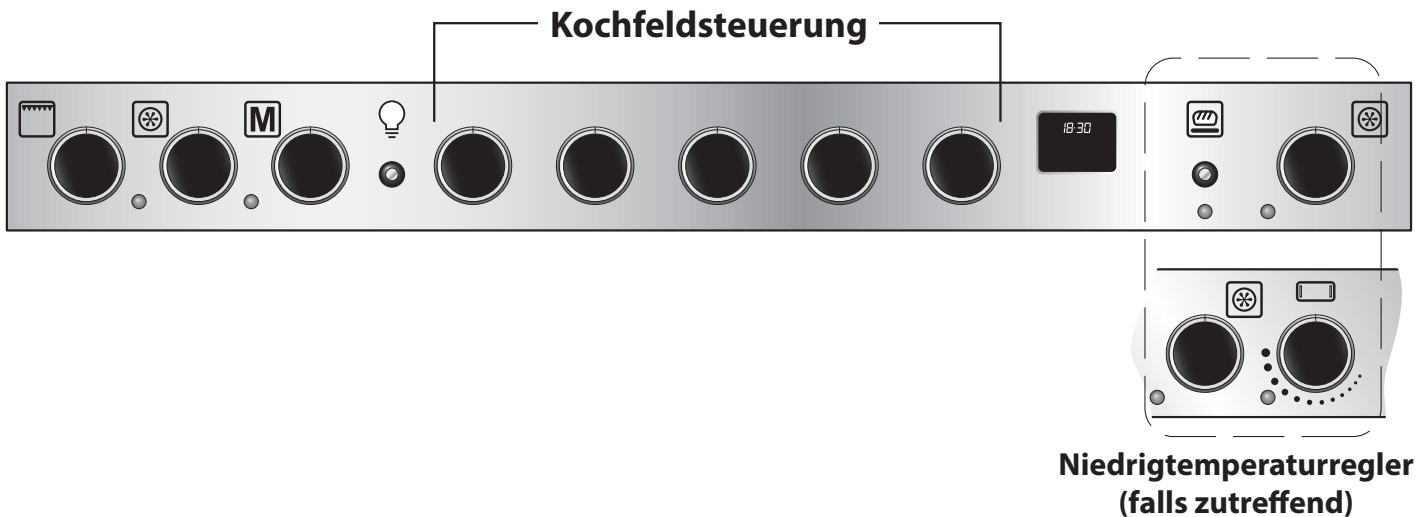

Grill	Temperaturregler linker Ofen	Multifunktionsofen-Auswahl (falls zutreffend)	Ofen Leuchte	Brotgärfach	Niedrigtemperatur-Ofen	Temperaturregler rechter Ofen

Identifizierung von Leuchten und Ofen – Einzelgarraum

Die Abbildungen neben den einzelnen Drehreglern sind repräsentativ und entsprechen möglicherweise nicht denen auf Ihrem Gerät.

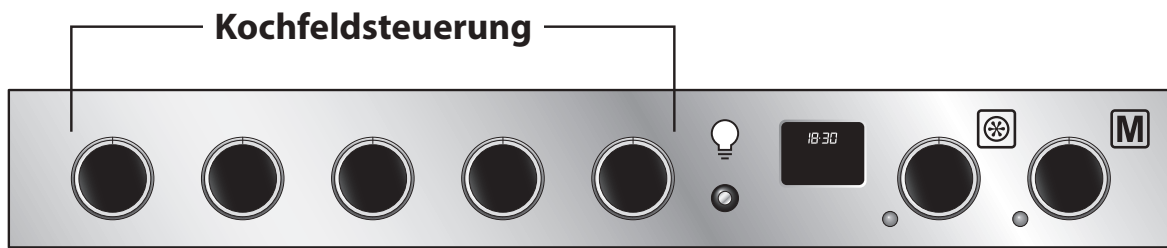

		
Temperaturregler	Multifunktionsofen- Auswahl	Ofen Leuchte

Der Grill

Betrieb des Grills

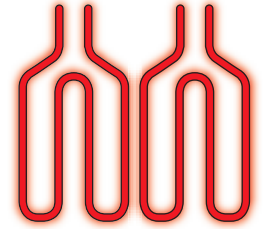
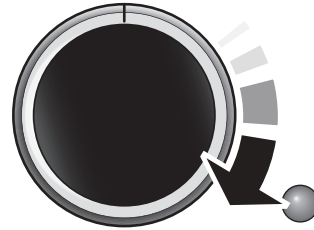
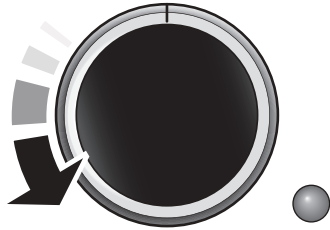
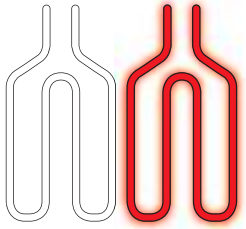

Einschalten des Halbelements

Einschalten beider Elemente

Höheneinstellung des Grillaufsatzes

A
Am nächsten zum
Element

B
Mittelhoch

C
Am weitesten vom
Element

D
Mittelniedrig

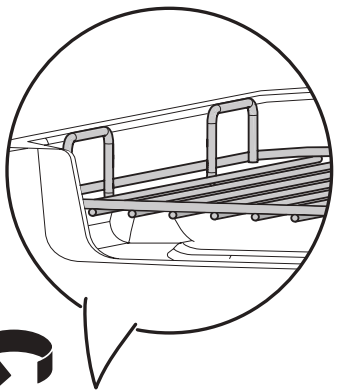
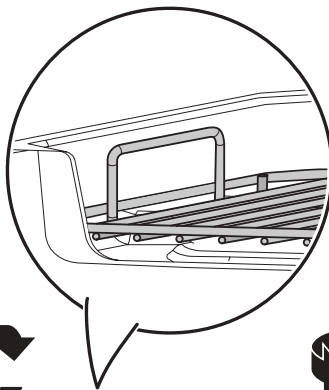
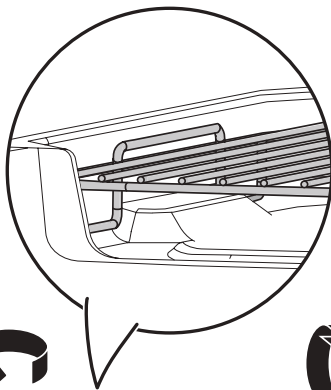
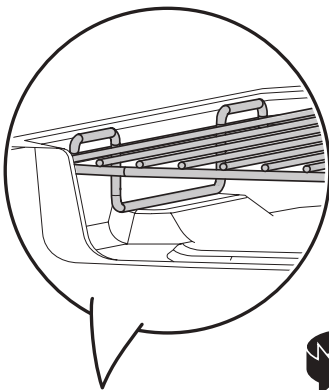

180°



180°



180°

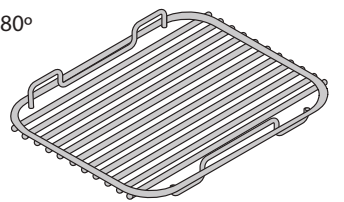
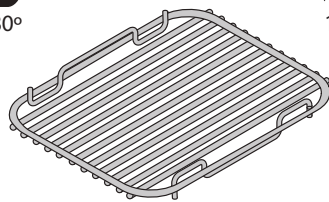
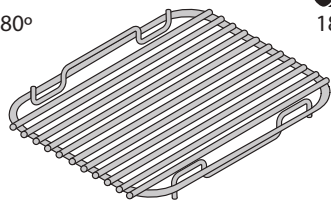
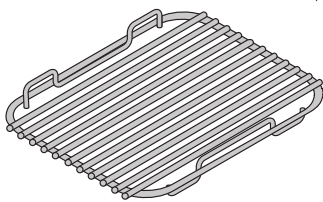

180°



Anbringen der Grill-Teleskopschiene

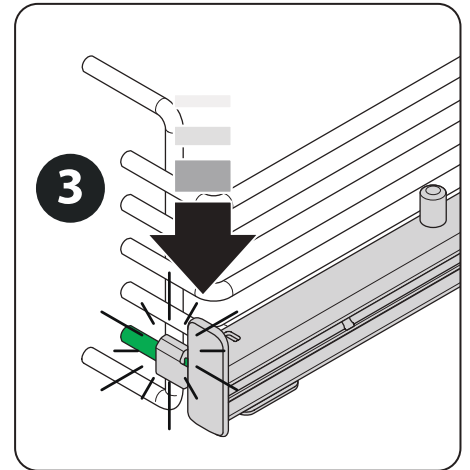
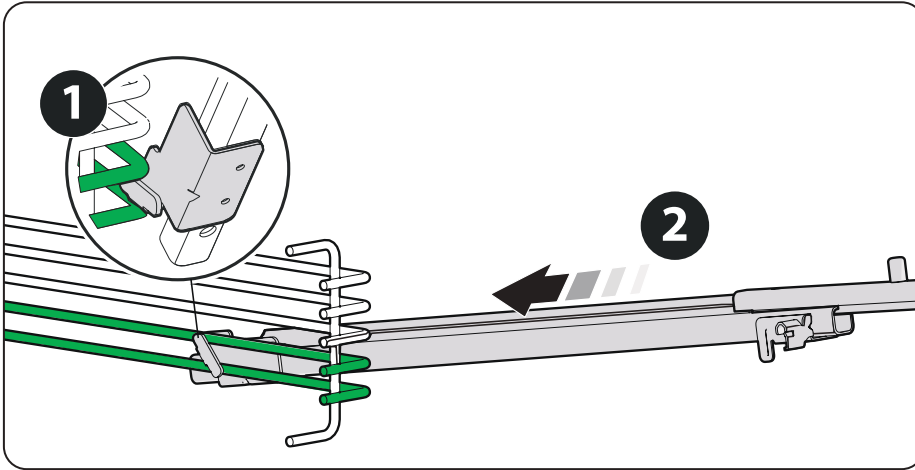

Anbringen/Entfernen von Grillpfanne

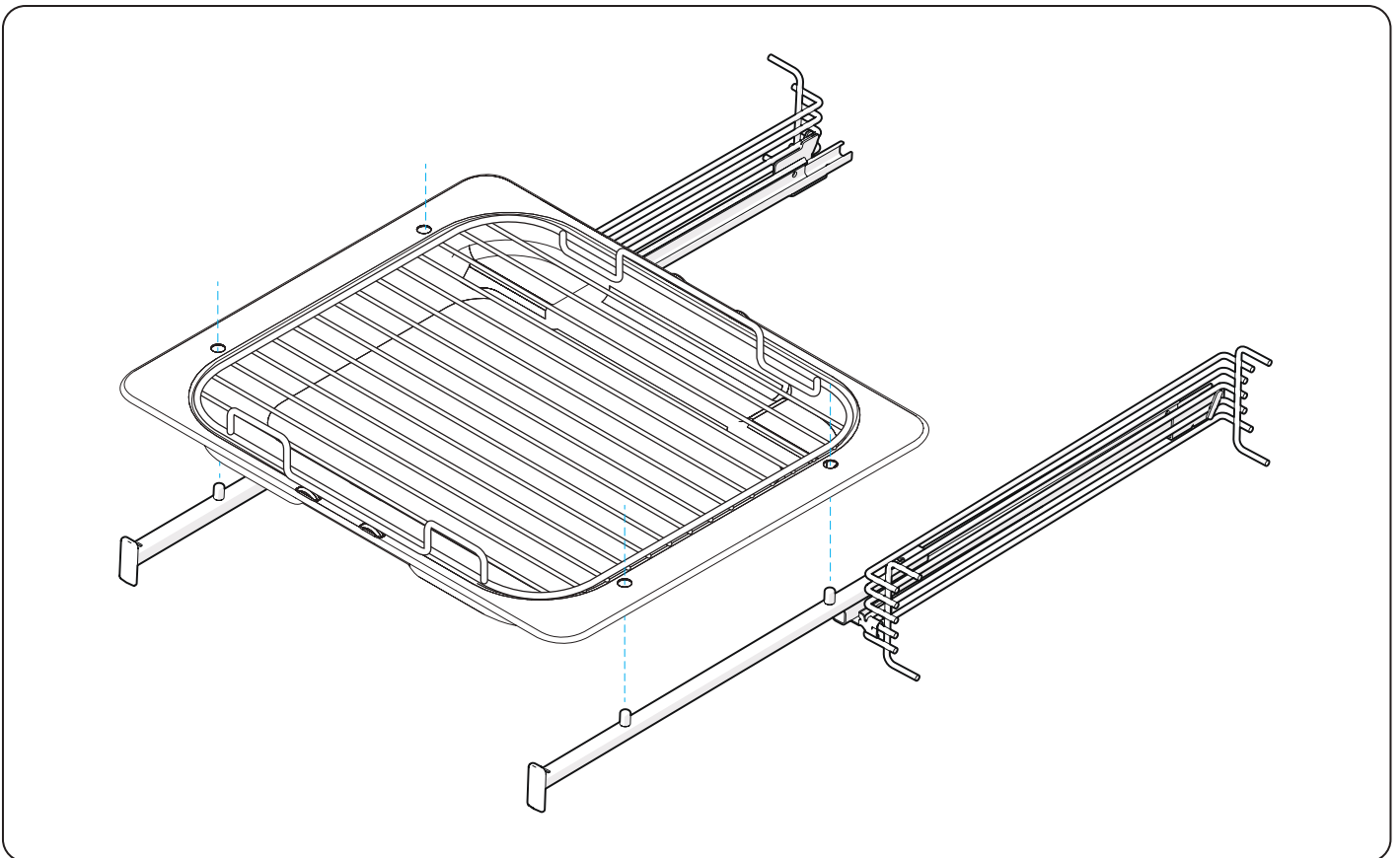

Einschubpositionen für die Grillpfanne

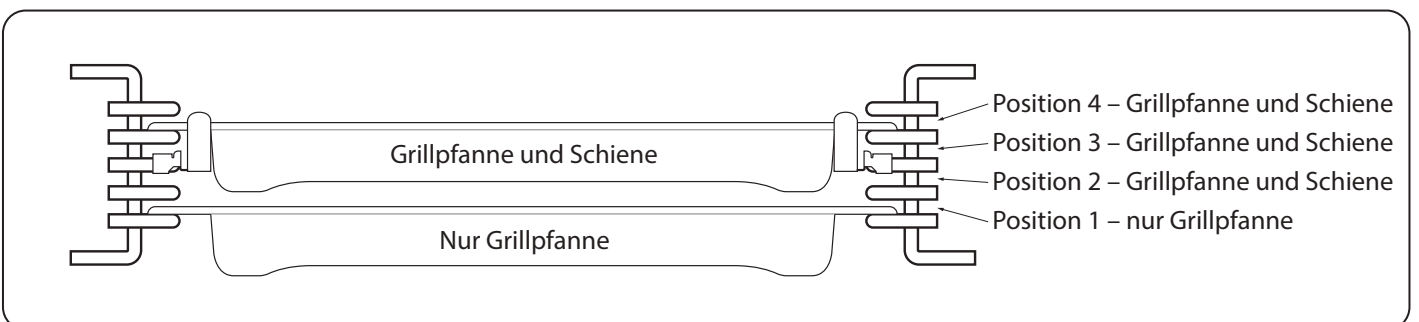

Die Öfen

Multifunktionsofen-Symbole

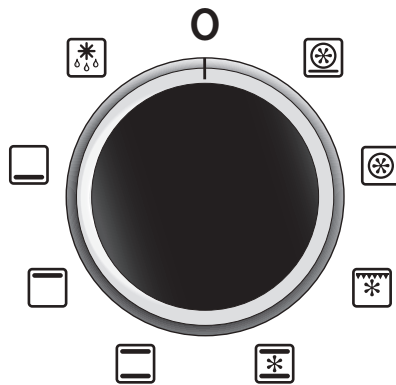

Duo	Umluftofen	Umluftgrillen	Mit zuschaltbarem Lüfter	Konventionell	Bräunen	Unterhitze	Auftauen

Um mehr über diese Funktionen zu erfahren, lesen Sie bitte die komplette Bedienungsanleitung.

Betrieb des Multifunktionsofens

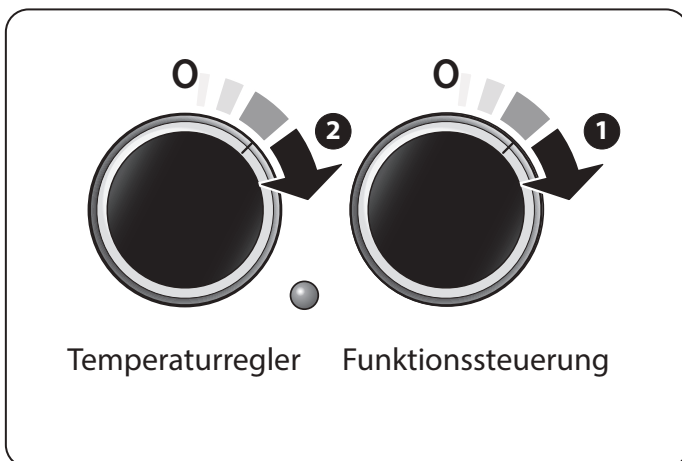

Betrieb des Umluftofens

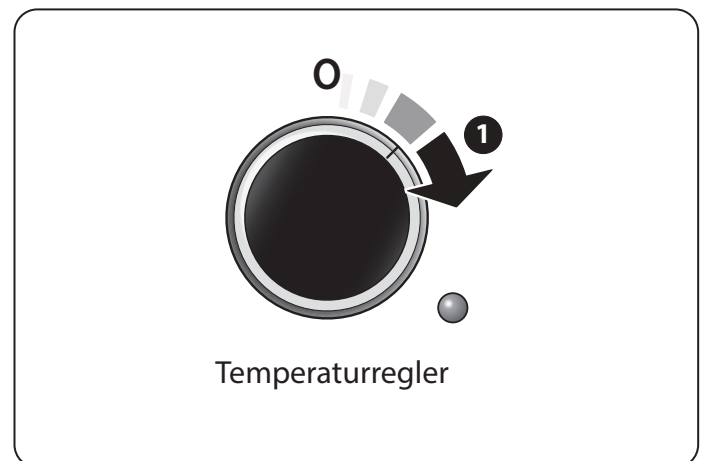

Ofenrosthalterung

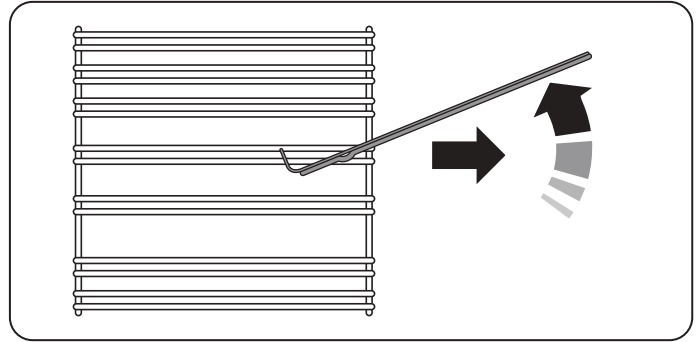
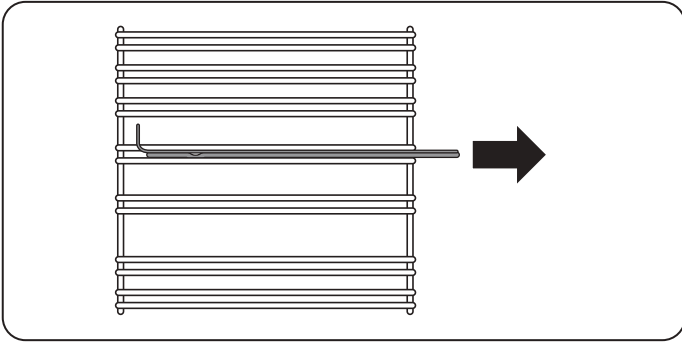

Teleskopische Ofenrosthalterung

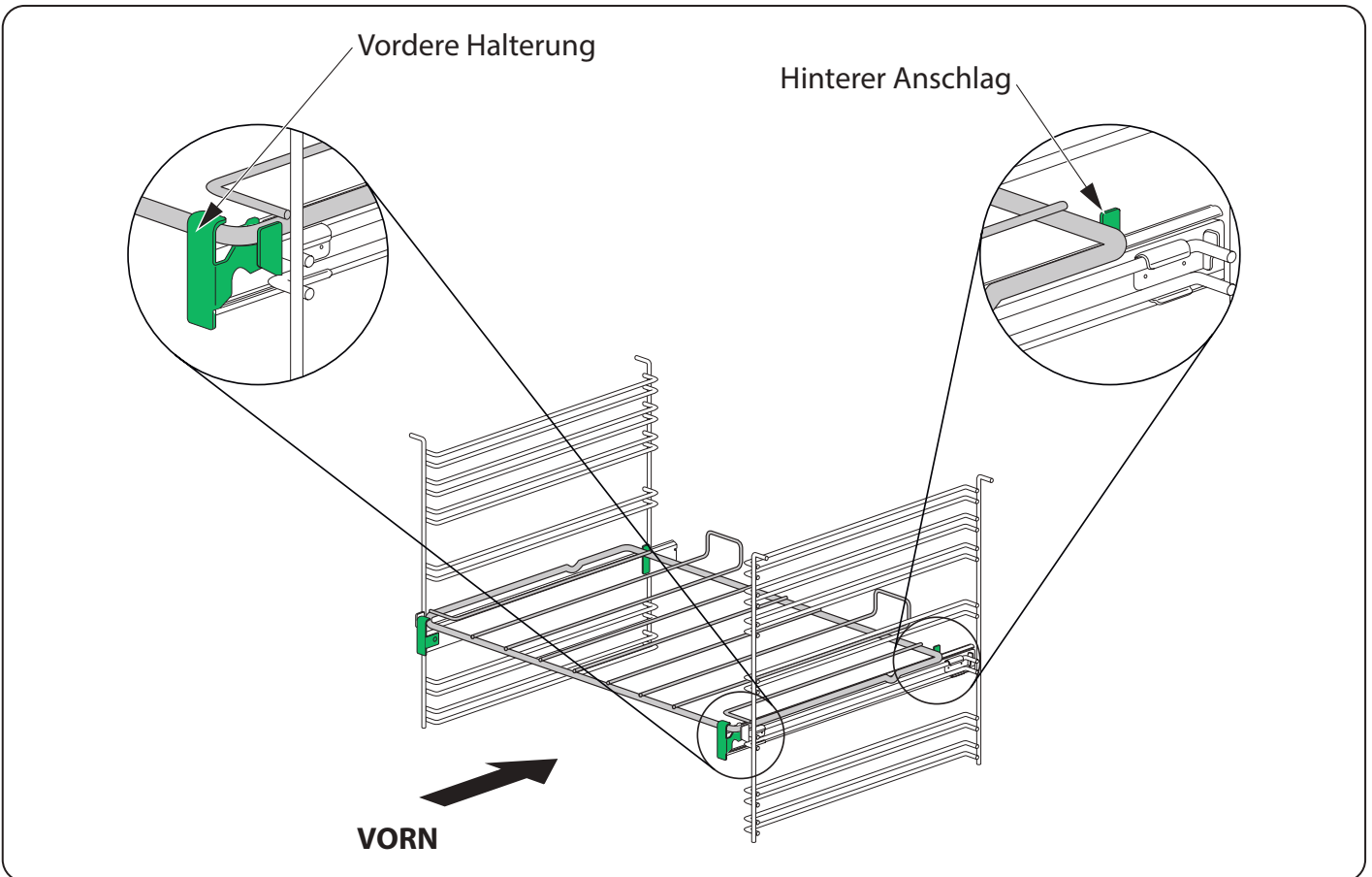
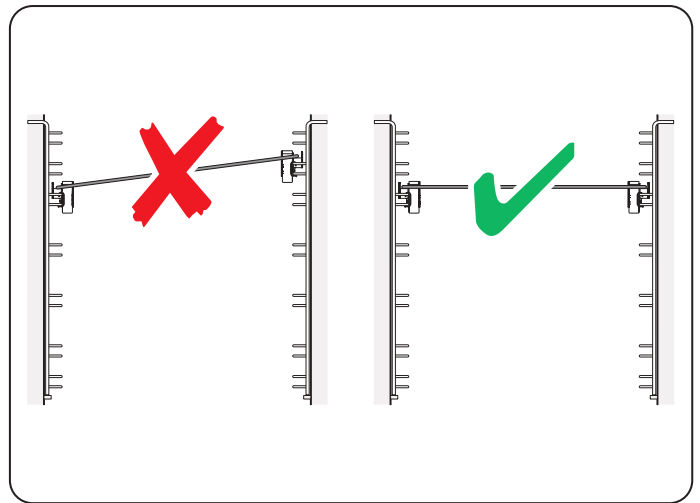
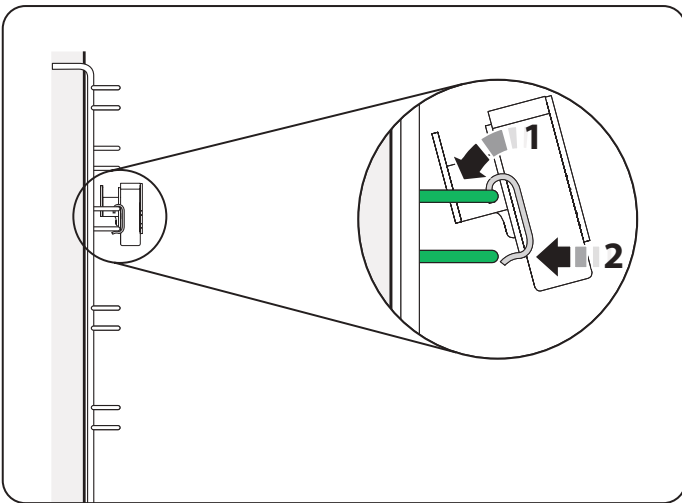

Einzelgarraum – Energiesparplatte

Energiesparplatte einsetzen

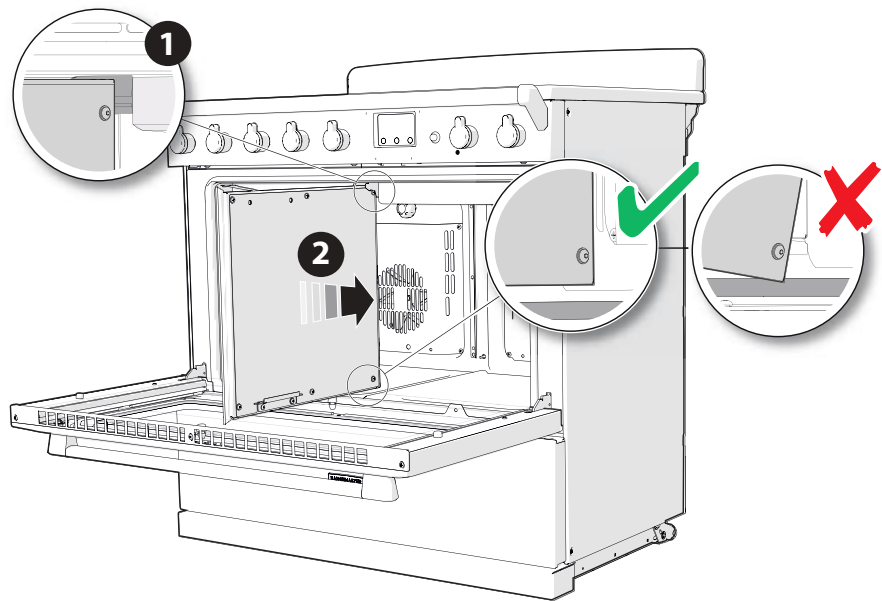

Stecken Sie die Gummidichtung entlang der inneren Glaskante.

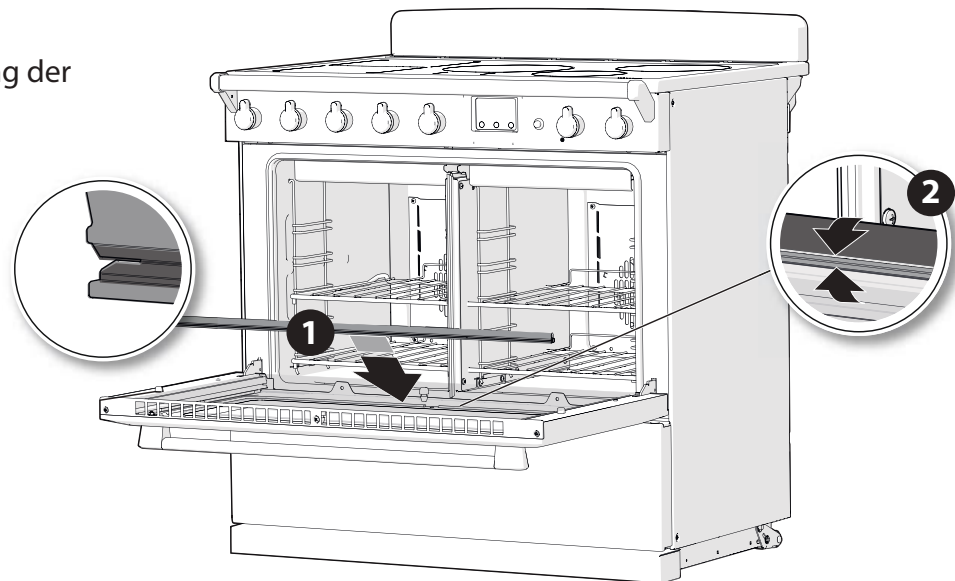

Energiesparplatte

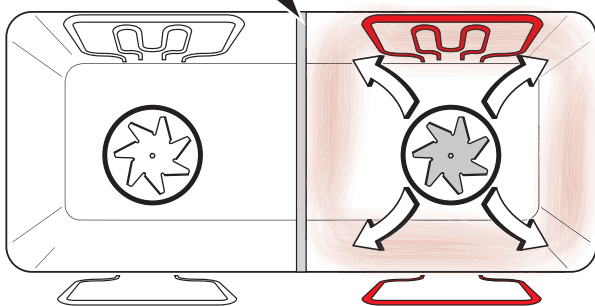

Energiesparplatte entnehmen

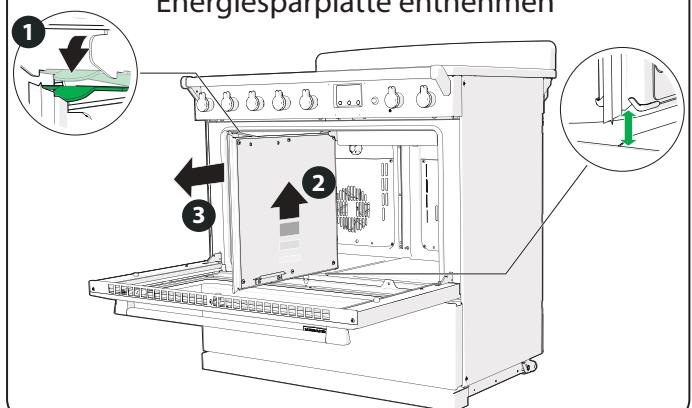

Kochfeld – Anordnung und Betrieb

Dualbrennstoff

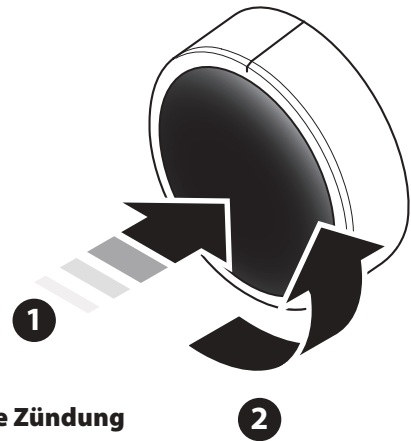
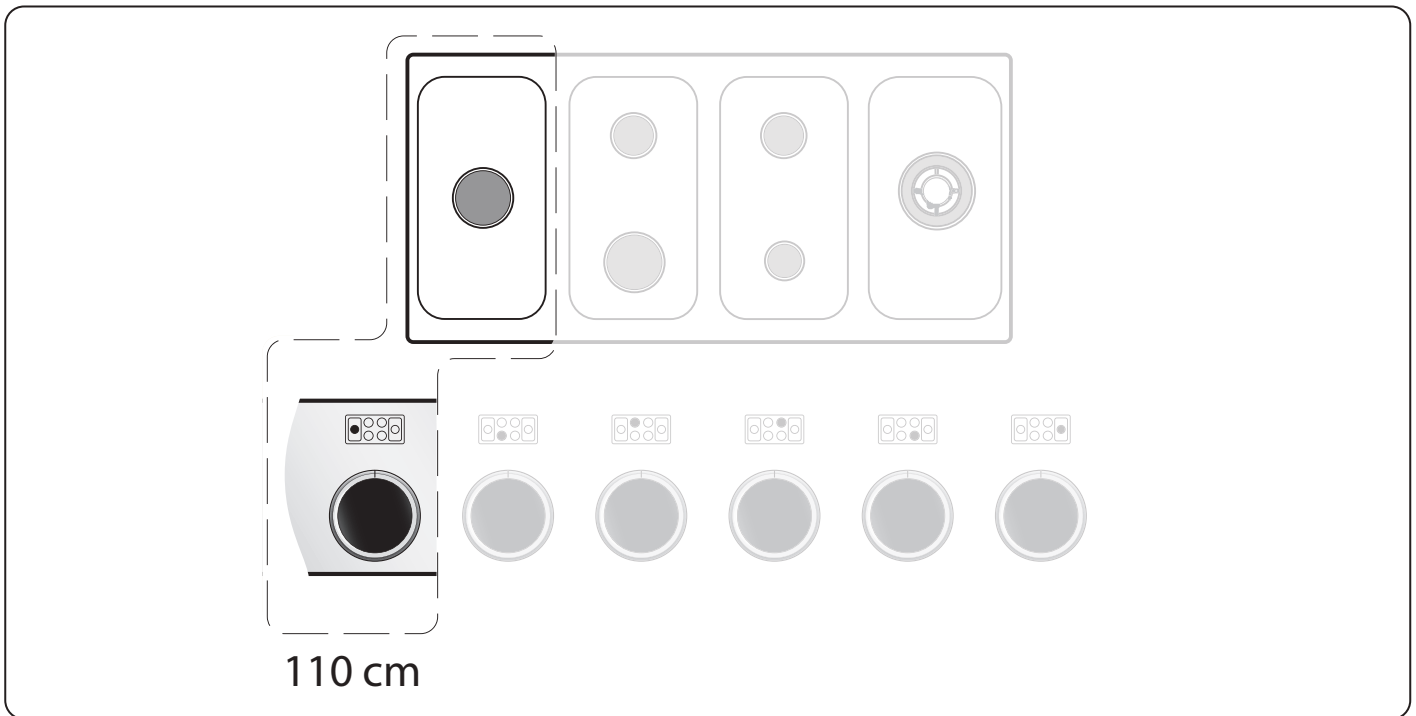

Einhändige Zündung

Modelle 110 cm mit Multi-Zone

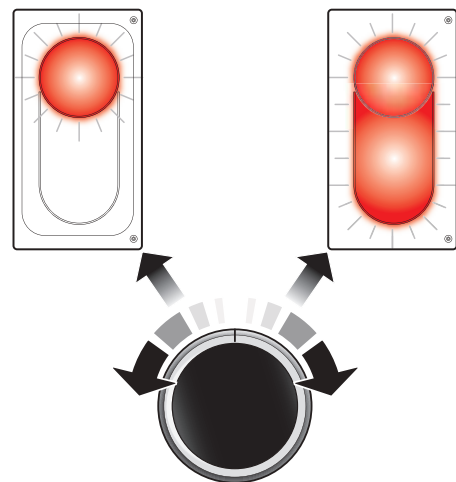
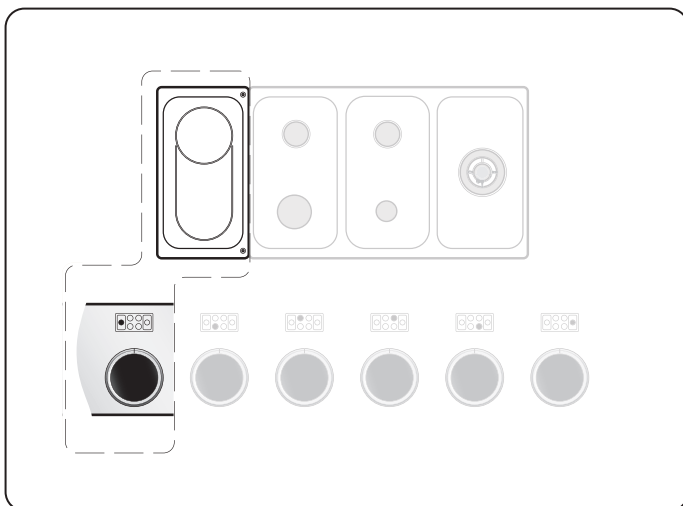

Kochfeld – Anordnung und Betrieb

Induktion für Kitchener

Leistungscheck des Kochgeschirrs

Verwenden Sie ein 1,85 kW Kochfeld (siehe Handbuch für die Einstufung der einzelnen Felder).

Füllen Sie ½ Liter Wasser mit Zimmertemperatur in einen Topf ohne Deckel (der Topfdurchmesser sollte nicht größer als das Kochfeld sein).

Stellen Sie das Kochfeld auf Stufe 9.

Das Wasser sollte nach 3 ½ Minuten kochen.

Längere Kochzeiten bedeuten, dass die Kochgeschirrkonstruktion nicht ideal dazu geeignet ist, die beste Leistung zu erbringen und es zu einem vorzeitigem Komponentenausfall kommen kann.

Inductie-indeling

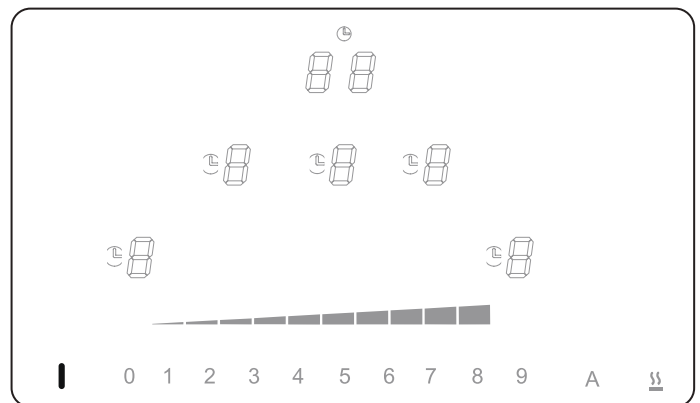
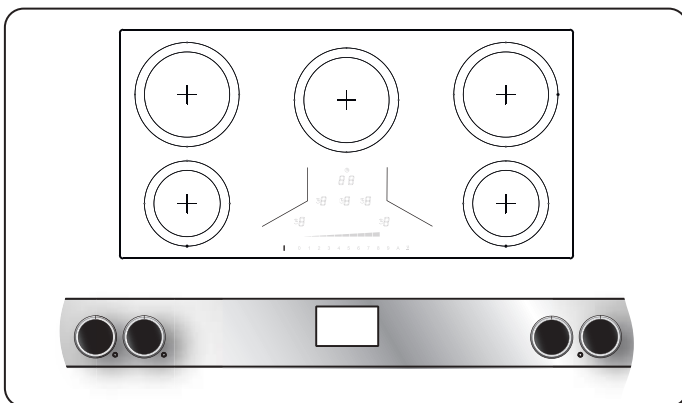

Induktionssymbole

Um die Funktionen auszuwählen, drücken Sie die jeweiligen Symbole auf dem Bildschirmpanel.

Betriebssequenz [Drücken Drücken und Wischen]	Anzeige	Funktion	Anzeige	Funktion
	CL	• Einschalten und Timer bereit	0...9 0 1 2 3 4 5 6 7 8 9	• Temperatureinstellungen - Stufe 1 bis 9
0 → SS	- SS blinken 0 1	• Niedrigtemperatur- Einstellungen - Nur Stufe 1	P	• Leistungssteigerungseinstellung
0 → A	A	• Automatisches Aufheizen (falls verfügbar)	H	• Restwärmeanzeige
CL → 0 → 0 1 2 3	99	• Timer-Einstellung, mit maximal 99 Minuten. • 1-Minuten-Timer; Countdown von 59 Sekunden.	U	• Keine Topfanzeige
			0	• Topf/Pfanne auf der jeweiligen Zone erkannt
			E #	• Anfrage für Serviceunterstützung
			ER	
			EH	
			Er	

Kochfeld – Anordnung und Betrieb

Induktion für Professional+ / Professional Deluxe

Leistungskochgeschirrs

1. Platzieren Sie es auf den entsprechenden Kochzonen, um die Leistung zu bewerten.
2. Drücken Sie und dann 3 Mal .
3. Drücken Sie .

Die Zone beginnt, den Topf zu bewerten, und die blinkende Sequenz wird angezeigt.

Wenn die Prüfung abgeschlossen ist, zeigt das Display an:-

Note 3 [] bedeutet Ausgezeichnet; Optimale Kochleistung.

Note 2 [] bedeutet Durchschnittlich; Reduzierte Kochleistung.

Note 1 [] bedeutet Schlecht.

Anordnung Induktion

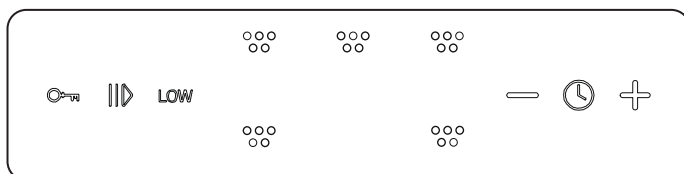
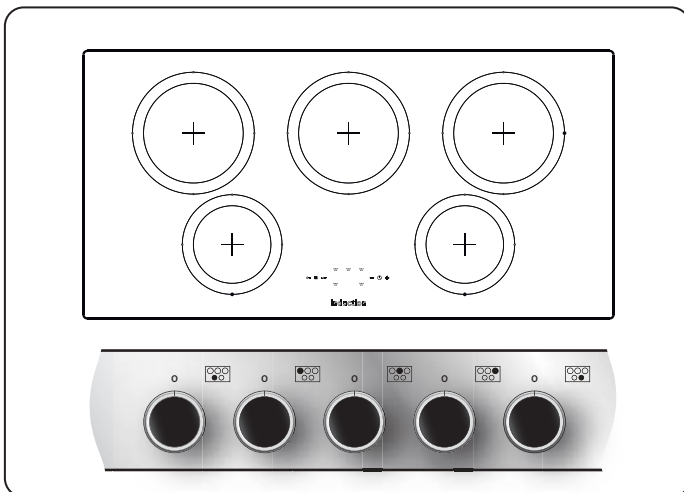

Anordnung mit Überbrückungszone

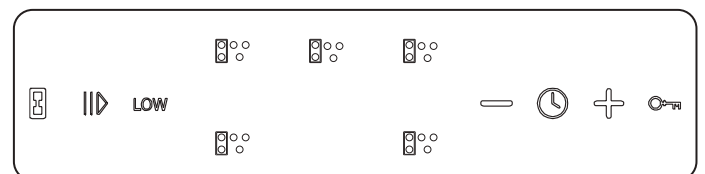
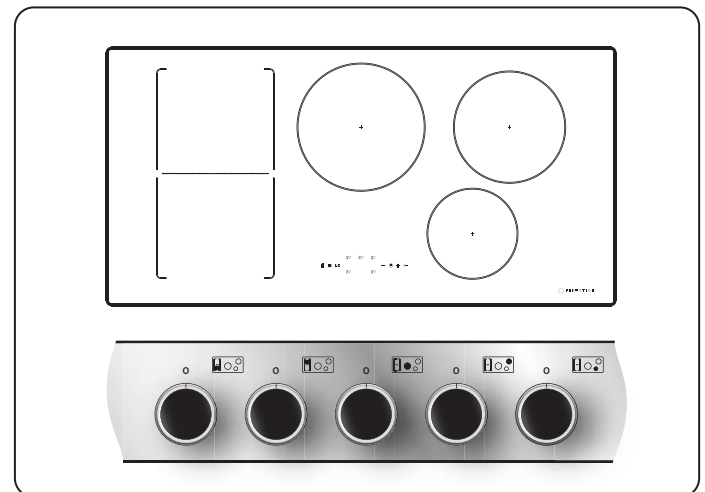

Induktionssymbole

Um die Funktionen auszuwählen, drücken Sie die jeweiligen Symbole auf dem Bildschirmpanel.

Betriebssequenz [Drücken]	Anzeige	Funktion	Anzeige	Funktion
	L	• Kindersicherung	1...9	• Temperatureinstellungen - Stufe 1 bis 9
	n	• Überbrückungsfunktion aktivieren/deaktivieren	P	• Leistungssteigerungseinstellung
		• Alle Kochzonen pausieren	H	• Restwärmeanzeige
	TIMER 99	• Timer-Einstellung mit maximal 99 Minuten.	ti	• Anfrage für Serviceunterstützung
LOW →	LOW 1...2...3	• Niedrige Temperatureinstellungen - Nur Stufe 1 bis 3	u	• Keine Topfanzeige

Kochfeld – Anordnung und Betrieb

Induktion

Anordnung Induktion

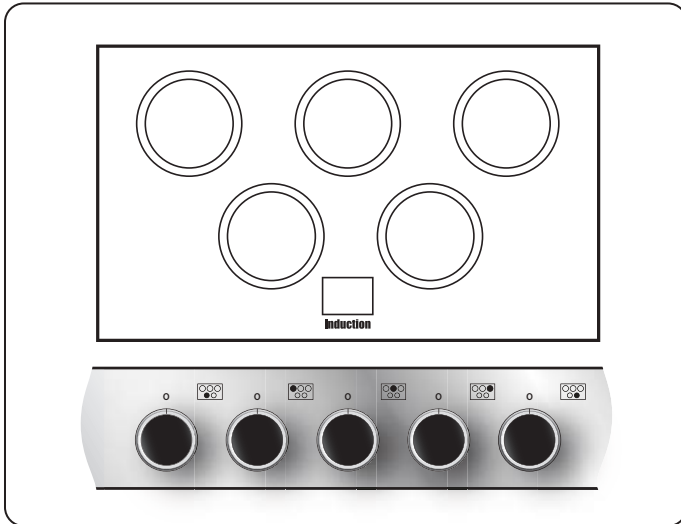

Anordnung mit Überbrückungszone

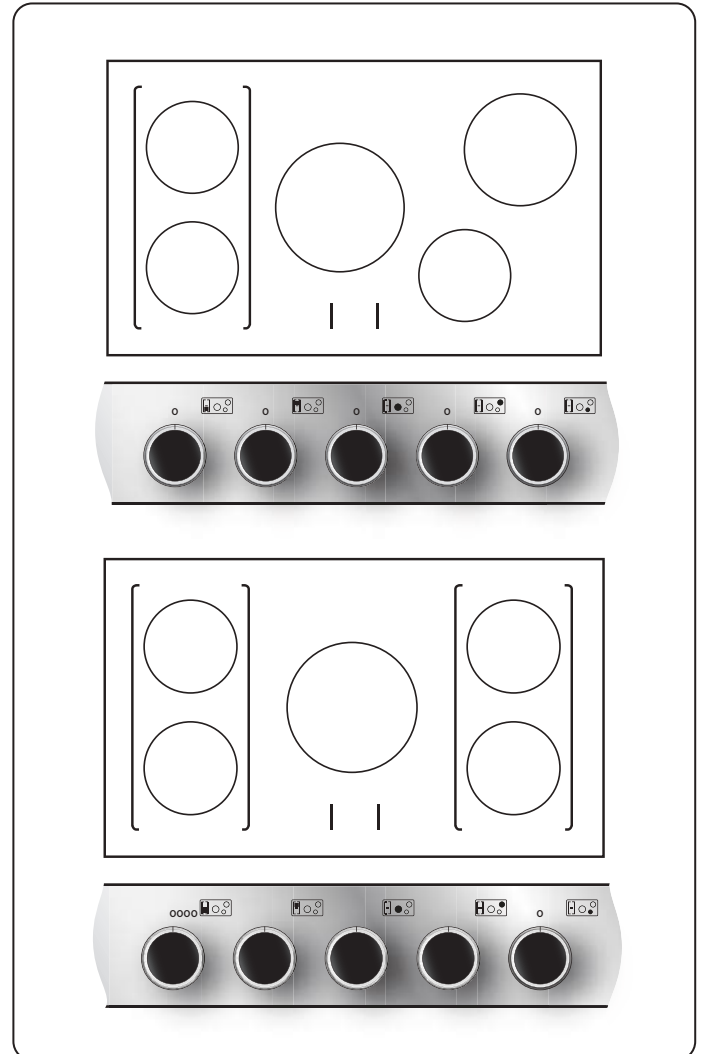

Leistungskcheck des Kochgeschirrs

Verwenden Sie ein 1,85 kW Kochfeld (siehe Handbuch für die Einstufung der einzelnen Felder).

Füllen Sie ½ Liter Wasser mit Zimmertemperatur in einen Topf ohne Deckel (der Topfdurchmesser sollte nicht größer als das Kochfeld sein). Stellen Sie das Kochfeld auf Stufe 9.

Das Wasser sollte nach 3 ½ Minuten kochen.

Längere Kochzeiten bedeuten, dass die Kochgeschirrkonstruktion nicht ideal dazu geeignet ist, die beste Leistung zu erbringen und es zu einem vorzeitigem Komponentenausfall kommen kann.

Induktionssymbole

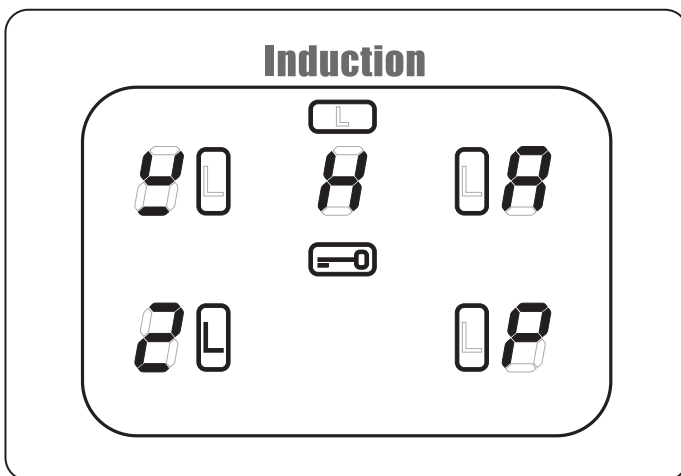

U	Keine Topfanzeige
H	Restwärmeanzeige
A	Automatisches Aufheizen – falls erhältlich
	Kindersicherung
	Niedrigtemperatur-Einstellung 1 - Schmelzen:
	2 - Kochen:
	Niedrigtemperatur-Einstellung 1 - Schmelzen:
	2 - Warm halten:
	3 - Kochen:
1...9	Temperatureinstellungen - Stufe 1 bis 9
P	Leistungssteigerungseinstellung
E 2	Die Temperatur von Topf oder Glas ist zu hoch. Lassen Sie das System abkühlen.
E 3	Ungeeignetes Kochgeschirr; führen Sie den Pfannentest durch oder verwenden Sie ein anderes Kochgeschirr.
E_r-E	Führen Sie einen manuellen Neustart durch. Wenn das Problem weiterhin besteht, wenden Sie sich an den Kundendienst.

Kochfeld – Anordnung und Betrieb

Keramik

Anordnung 110 cm

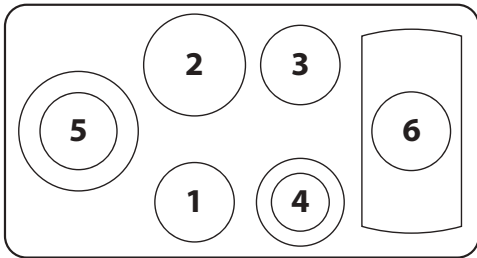

Anordnung 90 cm und 100 cm

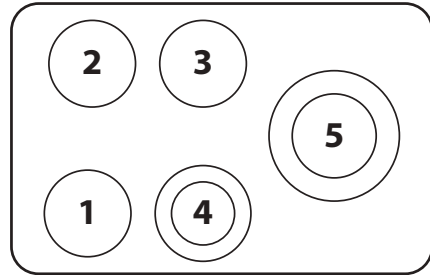

Doppelement-Kochfeldpositionen – 4 und 5

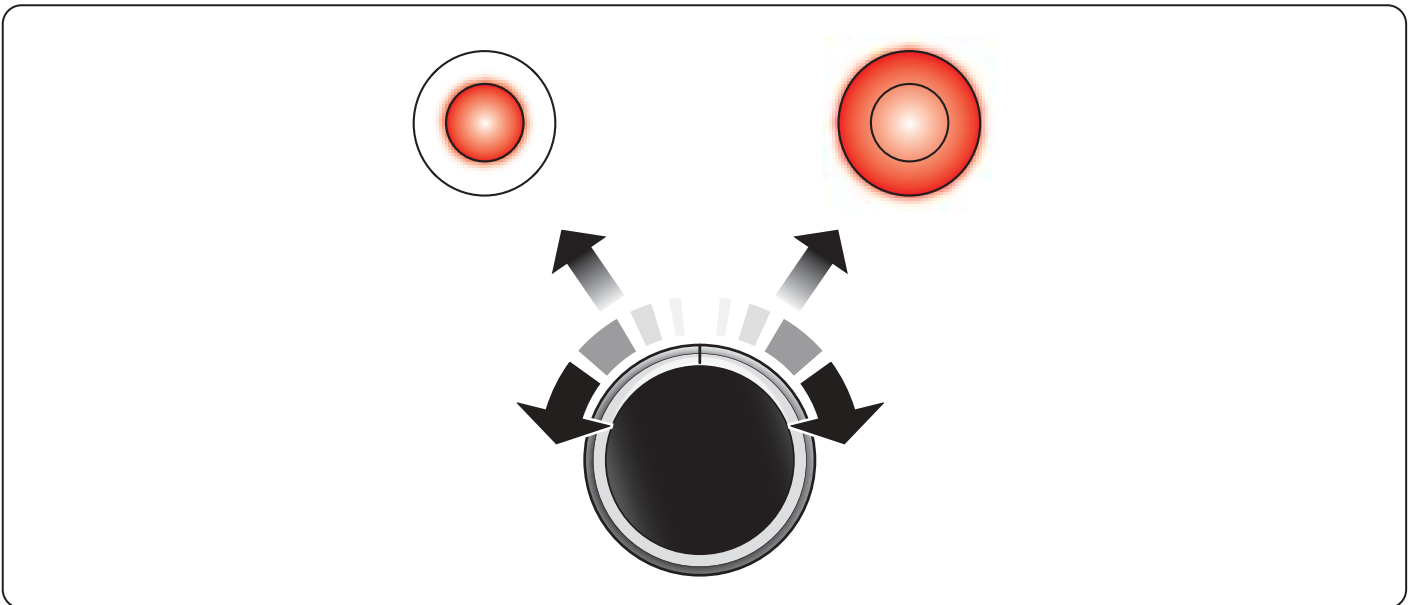

Warmhaltezone/Kochzone – 6

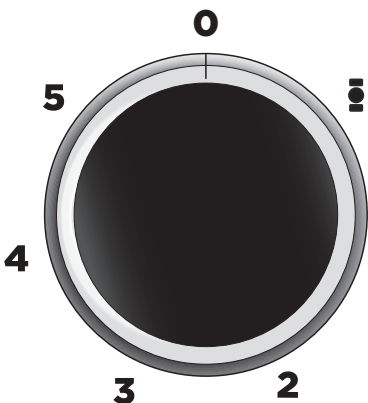

	1	2	3	4	5
Komplette Warmhaltezone	Niedrige Wärmeleistung	Mittlere Wärmeleistung – Butter schmelzen	Mittlere Wärmeleistung – Köcheln	Hohe Wärmeleistung	Sehr hohe Wärmeleistung

Pflege des Geräts

⚠ Schalten Sie die Stromversorgung ab, bevor Sie eine gründliche Reinigung durchführen. Lassen Sie das Gerät abkühlen.

Alle Teile des Herdes können mit warmer Seifenlauge gereinigt werden. **Achten Sie jedoch darauf, dass kein überschüssiges Wasser in das Gerät gelangt..**

Ein ausführliche Liste der empfohlenen Reinigungsmethoden für alle Teile des Herds finden Sie in der Bedienungsanleitung.

- Regelmäßige Reinigung wird empfohlen. Zur leichteren Reinigung nehmen Sie verschüttete Speisen sofort auf.
- Alle Teile des Herdes können mit warmer Seifenlauge und einem weichen Tuch oder E-Tüchern gereinigt werden.
- Für hartnäckige Flecken, die sich nicht mit Seifenlauge und einem weichen Tuch entfernen lassen, können Scheuermilch und Nylon-Topfreiniger verwendet werden.
- Ein spezielles, für Emaille geeignetes Ofenreinigungsmittel kann für den Boden und die Rückseite des Garraums und andere Emailleoberflächen verwendet werden. Achten Sie darauf, dass diese Chemikalien nicht mit den Ofenelementen oder den katalytischen Beschichtungen in Kontakt kommen.
- Verwenden Sie niemals Lösungsmittel, Waschsoda, bioaktive Pulver, Bleichmittel, Chlorbleiche, grobe Scheuermittel oder Salz.
- Verwenden Sie niemals Stahlwolle, Topfreiniger oder andere Materialien, die Kratzer auf der Herdoberfläche hinterlassen können.
- Auf Induktions- und Glaskeramik-Kochfeldern kann ein spezieller Reinigungsschaber verwendet werden, um hartnäckige eingebrannte Rückstände zu entfernen.

Spülmaschinenfeste und nicht spülmaschinenfeste Teile

Spülmaschinenfeste Teile	Nicht spülmaschinenfeste Teile
Ofenroste	Seitliche Schienen
Handyrack	Seitenverkleidung
Teller-Warmhalterost	Brennerköpfe
Broilerpfanne	Auszugschienen
Fleischbräter (auf Handyrack)	Broiler-Auszugschienen
Brennerkappen	Drehregler
Grillplatten (mit Ausnahme der Induktionsgrillplatte)	Induktionsgrillplatte
Topfträger	
Wok-Ständer	

Testgerichte

Backen

Nach EN60350-1

Diese Kochtabelle wurde für Prüfinstitute erstellt, um die Prüfung von Geräten zu erleichtern.

* Vorgeheizt

** Fatless Sponge

Gericht	Backblech /Backform	Ofenfunktion	Einschubhöhe	Temperatur	Zeit
Shortbread	Backblech von 34 cm x 34 cm	Gefächerter Backofen	3	160°C*	12 minuten
Shortbread	Backblech von 34 cm x 34 cm	Konventioneller Ofen	3	170°C*	12 minuten
Shortbread, 2 backbleche	Backblech von 34 cm x 34 cm	Gefächerter Backofen	2 & 4	160°C*	12 minuten
Shortbread, 3 backbleche	Backblech von 34 cm x 34 cm	Gefächerter Backofen	1, 3 & 5	160°C*	12 minuten
Törtchen	Backblech von 34 cm x 34 cm - 16 Kuchen pro Backblech	Gefächerter Backofen	3	160°C*	30 minuten
Törtchen	Backblech von 34 cm x 34 cm - 16 Kuchen pro Backblech	Konventioneller Ofen	2	180°C*	30 minuten
Törtchen, 2 backbleche	Backblech von 34 cm x 34 cm - 16 Kuchen pro Backblech	Gefächerter Backofen	2 & 4	160°C*	30 minuten
Törtchen, 3 backbleche	Backblech von 34 cm x 34 cm - 16 Kuchen pro Backblech	Gefächerter Backofen	1, 3 & 5	160°C*	30 minuten
Fettfreier Biskuit**	Springform von 26 cm	Gefächerter Backofen	3	170°C*	35 minuten
Fettfreier Biskuit**	Springform von 26 cm	Konventioneller Ofen	2	180°C*	35 minuten
Fettfreier Biskuit**, 2 Ofenregale	Springform von 26 cm	Gefächerter Backofen	2 & 4	160°C*	30 minuten
Apple pie	Backform mit 20 cm Durchmesser	Gefächerter Backofen	3	200°C*	45 minuten
Apple pie	Backform mit 20 cm Durchmesser	Konventioneller Ofen	2	210°C*	45 minuten
Apple pie, 2 Ofenregale	Backform mit 20 cm Durchmesser	Gefächerter Backofen	2 & 4	200°C*	45 minuten



**Backofen-
Einschubpositionen**



Grillrostpositionen

Grill * Vorheizen für 3 minuten **Die Speisen zur Hälfte bis zwei Drittel der Garzeit wenden

Gericht	Backblech/Backform	Grillstufe	Rostposition	Position des Untersetzers	Zeit
Toast	Grill pan and trivet	3*	3	Highest	3-4 minuten**
Beefburger	Grill pan and trivet	3*	3	Highest	15 minuten**

Innan du börjar

- Kontrollera att **ALLT** förpackningsmaterial har tagits bort.
- Ställ in klockan på rätt tidpunkt.
- Kontrollera att rummet är väl ventilerat.
- Ställ in ugnarna på 200°C och låt stå på under minst en timme för att avlägsna all lukt.
- Starta grillen och låt den stå på i 30 minuter med grillpannan på plats, intryckt hela vägen och med grillluckan öppen.
- Låt apparaten svalna och torka därefter av emalj- och glasytor med en ren och luddfri fuktig torkduk.
- Se käreless prestandauppgifter på sida 73
- Mer information, inklusive hela bruksanvisningen samt teknisk information och installationsinformation finns under **Ytterligare support** avsnittet på sida 79.

Layout för din produkt

110 cm-modeller

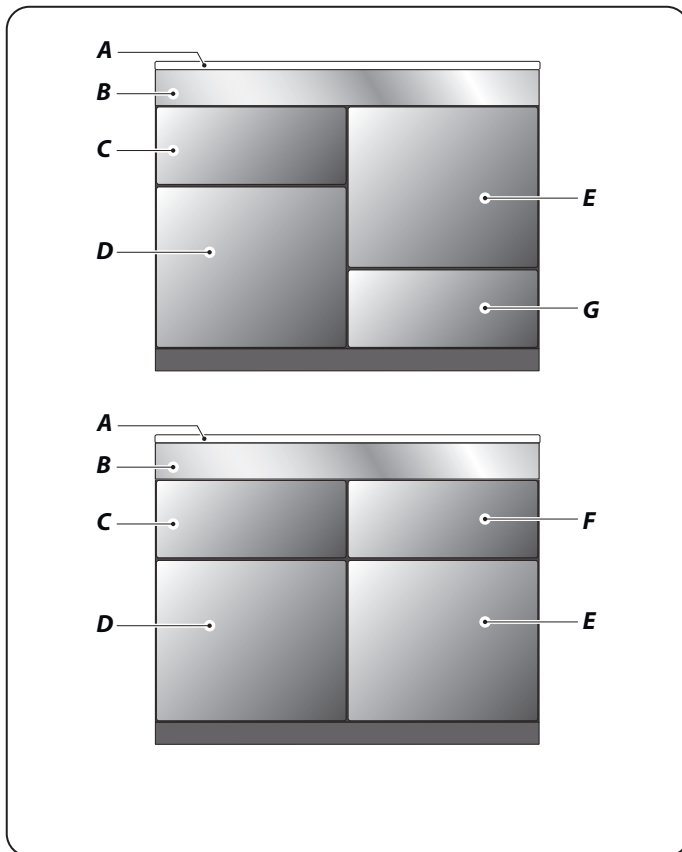

- A. Häll
- B. Kontrollpanel
- C. Grill
- D. Multifunktionsugn/Fläktugn
- E. Fläktugn
- F. Långkoksugn
- G. Brödjäsningslåda/Lagringslåda

90 cm- och 100 cm-modeller

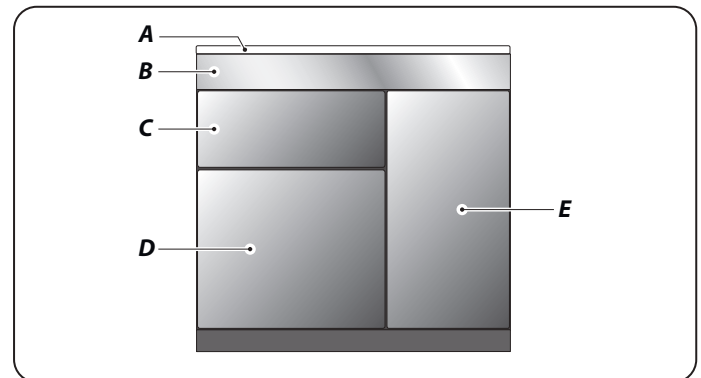



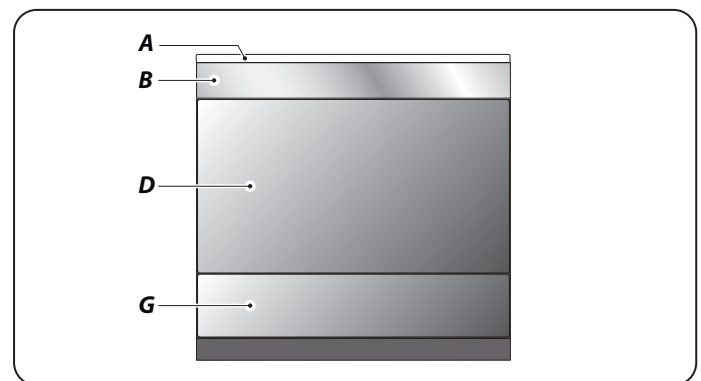























































































































































Enkelt utrymme



Medföljande tillbehör









-  Medföljer induktionsapparater
-  Medföljer apparaten
-  Medföljer dubbelbränsleapparater
-  Finns som tillval extra















































Alla mått anges i centimeter

	Wokhållare	Klassiskt stekbord	Stekbord Deluxe	Induktionsstekbord	Grillpanna	Teleskopiska sidosenor	Plan hylla Huvudugn	Hylla för hög ugn	Tallriksrack	Handyrack & tråg
Cotswold							 x2	 x4		
Camden							 x2	 x4		
Estate						 x1	 x2	 x4		
Classic						 x1	 x2	 x4		
Infusion Classic						 x1	 x2	 x4		
Professional +						 x1	 x2	 x4		
Infusion						 x1	 x2	 x4		
Toledo						 x1	 x2	 x4		
Longstock						 x1	 x2	 x4		
Classic Deluxe						 x1	 x2	 x4		
Estel Deluxe						 x1	 x2	 x4		
Leckford Deluxe						 x1	 x2	 x4		
Professional Deluxe						 x1	 x2	 x4		
Longstock Deluxe						 x1	 x2	 x4		
Encore Deluxe						 x1	 x2	 x4		
Edge Deluxe						 x1	 x2	 x4		
Arina Nexus						 x2	 x4	 x4		
Elise						 x2	 x4	 x4		
Stanley Supreme						 x2	 x4	 x4		

Medföljande tillbehör – Enkelt utrymme

-  Medföljer induktionsapparater
-  Medföljer apparaten
-  Medföljer dubbelbränsleapparater
-  Finns som tillval extra

Wokhållare	Klassiskt stekbord	Induktionsstekbord	Hylla för enkelt utrymme	Stöd för grillpanna	Grillpanna	Grillunderlägg	Halv hylla	Energisparpanel
								

Classic Deluxe			 x2	 x1	 x2	 x2	 x3	 x1
Estel Deluxe			 x2	 x1	 x2	 x2	 x3	 x1
Professional Deluxe			 x2	 x1	 x2	 x2	 x3	 x1
Arina			 x2	 x1	 x2	 x2	 x3	 x1
Nexus			 x2	 x1	 x2	 x2	 x3	 x1
Elise			 x2	 x1	 x2	 x2	 x3	 x1

Komma igång

Ställa in klockan

Klockan måste ställas in och visa rätt tid innan ugnarna kan fungera.

Step. 1



Tryck på klockknappen [🕒] eller tryck på knapparna [+] och [-] samtidigt för att gå till klockinställningen. Decimalpunkten [·] blinkar.

Step. 2

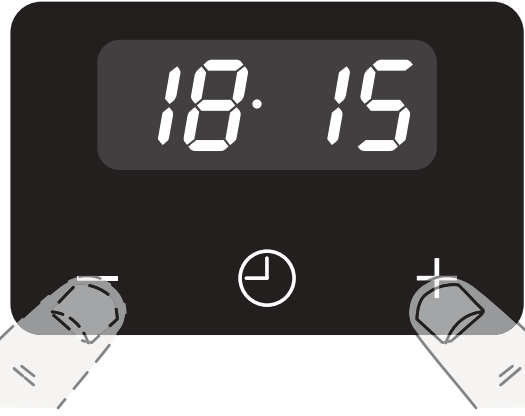

Använd knapparna [+] eller [-] för att ställa in rätt tid.

Identifiering av lampor för ugn och grill

Symbolerna bredvid varje reglage är representativa men kanske inte ser exakt likadana ut på din produkt.

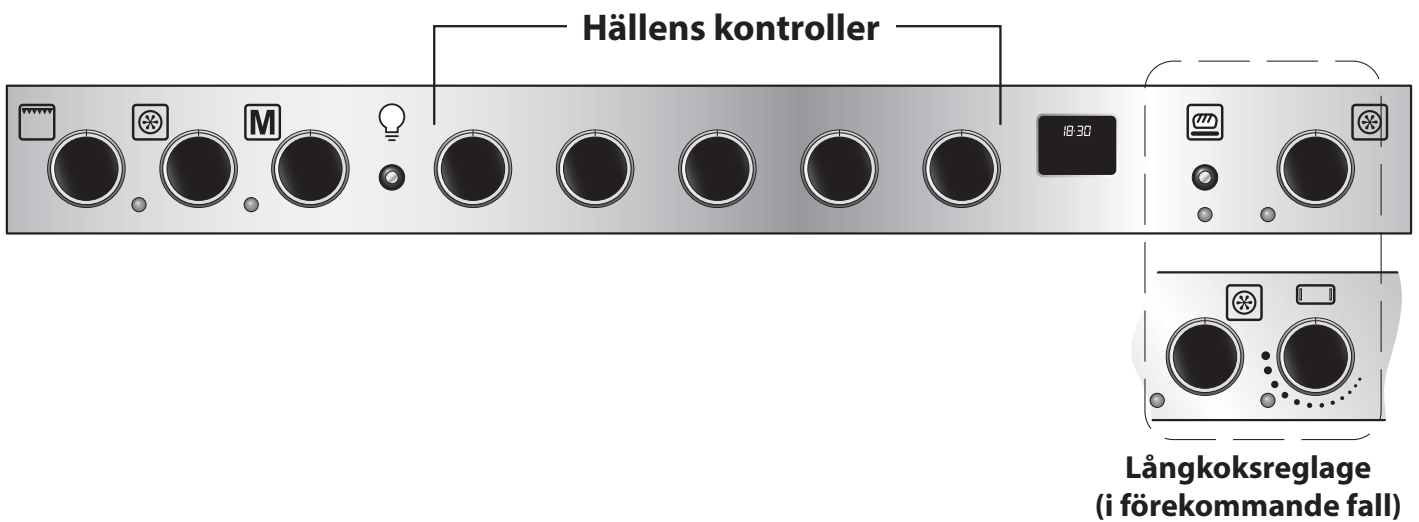

Grill	Vänster ugn - temperatur- reglering	Väljare för multifunktionsugn (i förekommande fall)	Ugn Lampa	Brödjäsning -slåda	Långkoksugn	Höger ugn - temperatur- reglering

Identifiering av lampor för ugn – enkelt utrymme

Symbolerna bredvid varje reglage är representativa men kanske inte ser exakt likadana ut på din produkt.

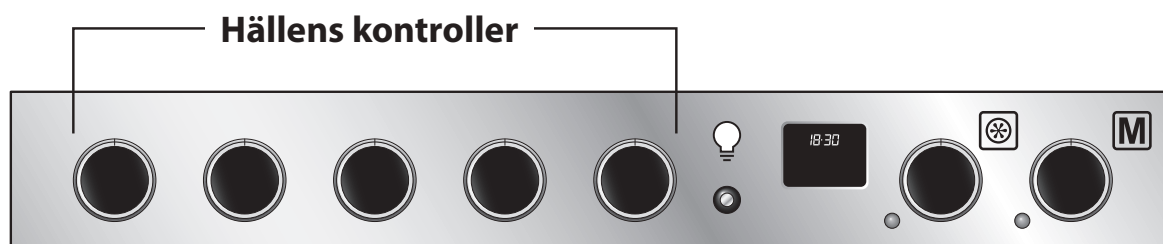

		
Temperatur -reglering	Väljare för multifunktionsugn	Ugn Lampa

Grillen

Använda grillen

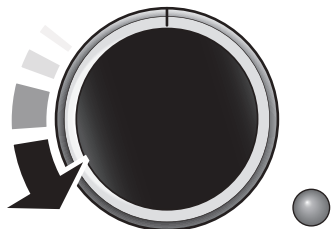
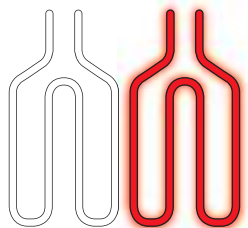

För att slå på halvelementet

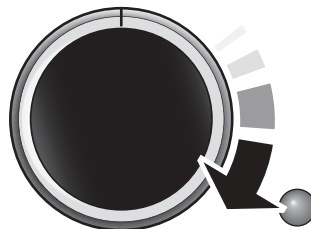

För att slå på båda elementen

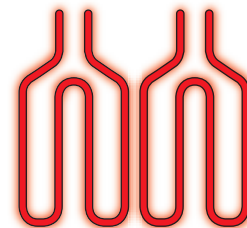

Justera grillunderlagets höjd

A
Närmast elementet

B
Medelhög

C
Längst bort från elementet

D
Medellåg

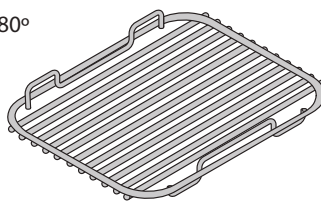
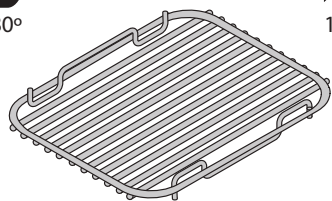
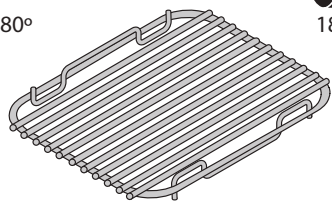
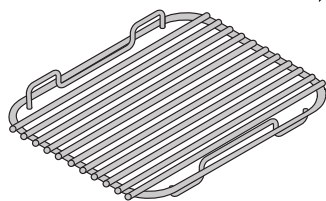
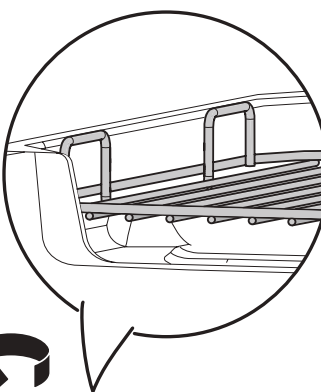
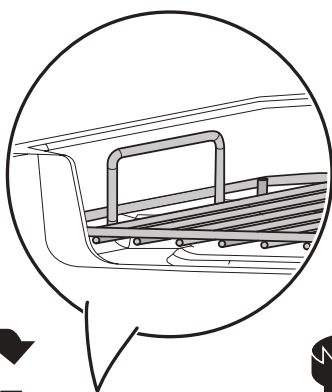
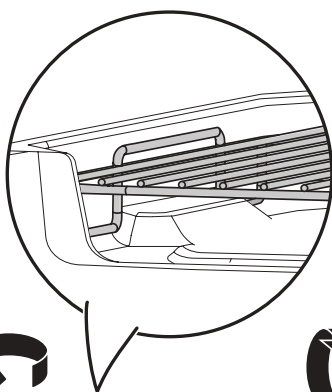
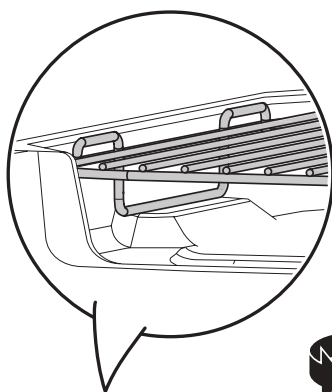

180°

Montera grillens teleskopprofil

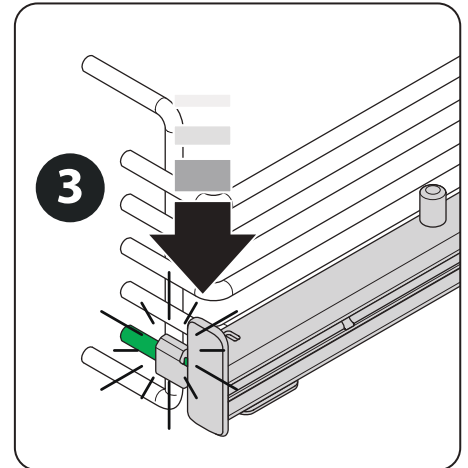
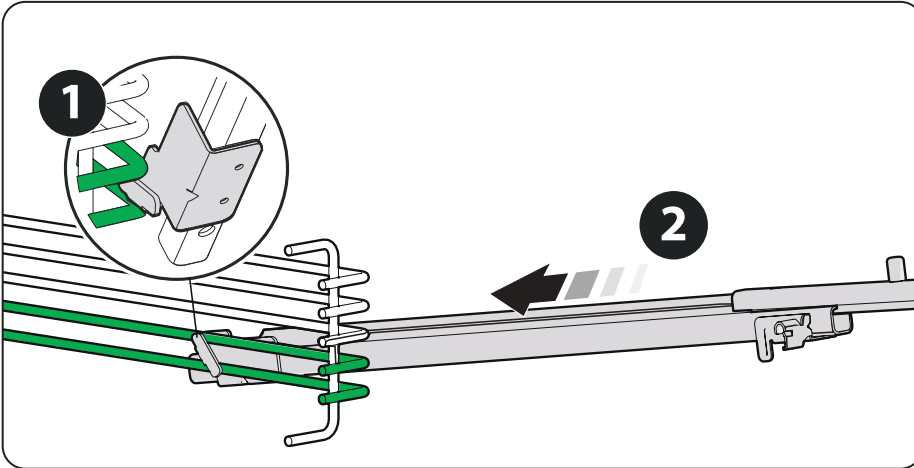

Montera/ta bort grillpannan

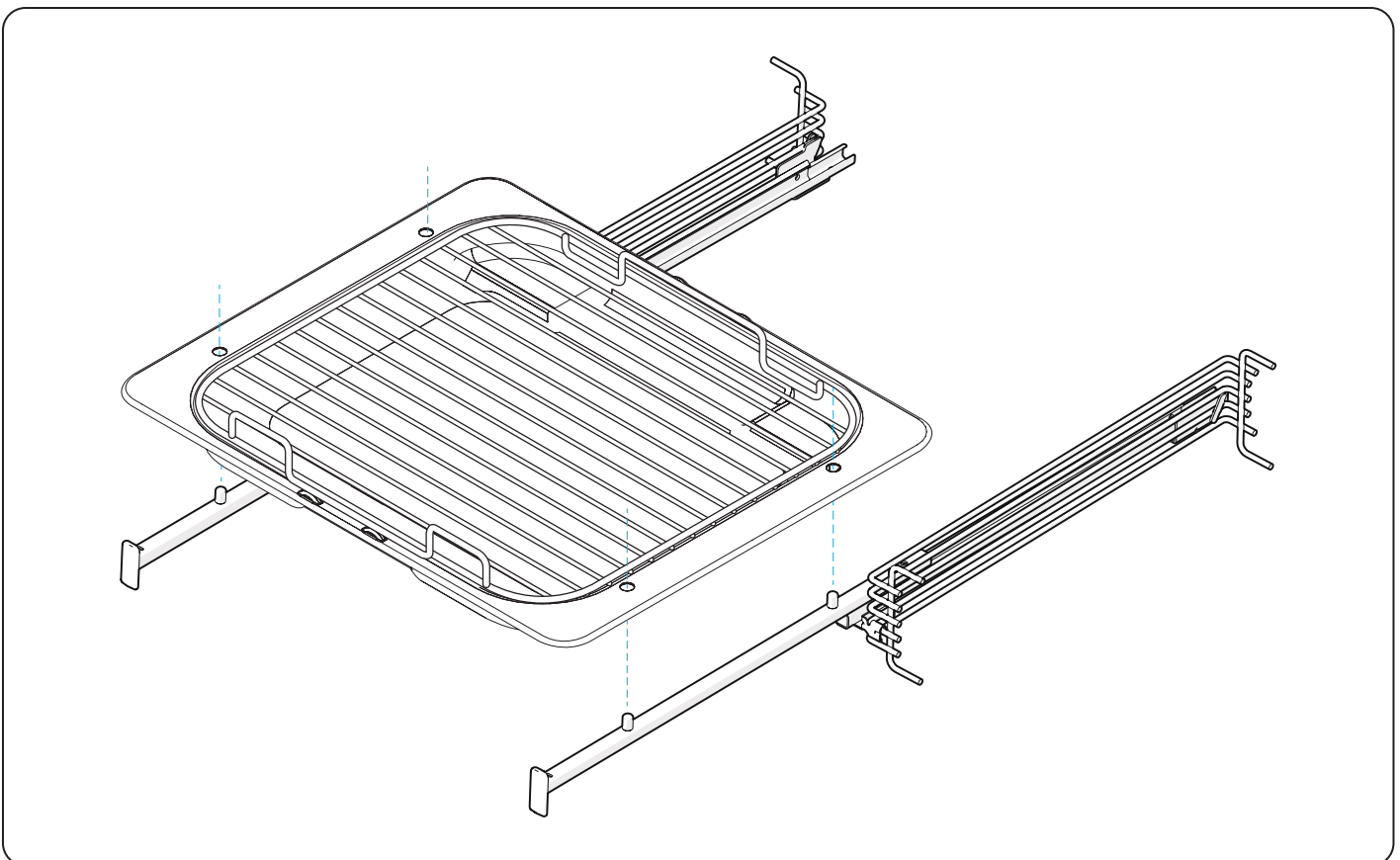

Grillpannans positioner

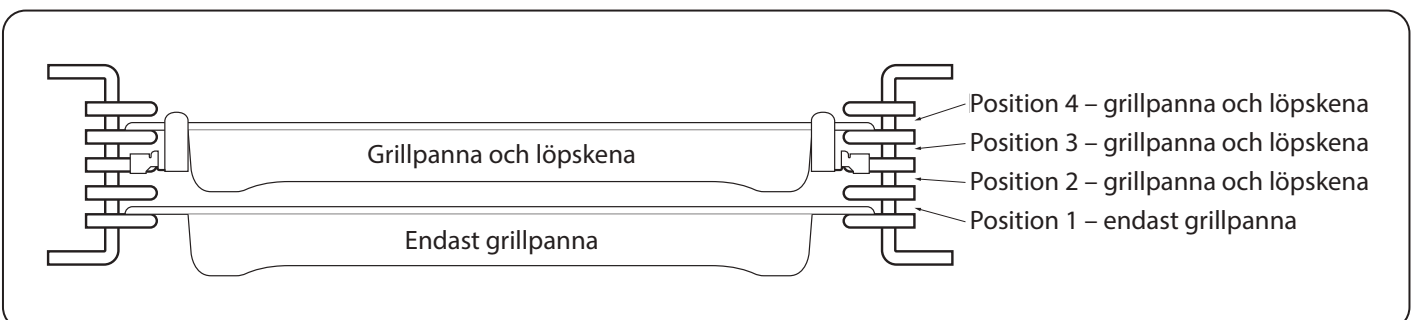

Ugnarna

Symboler på multifunktionsugn

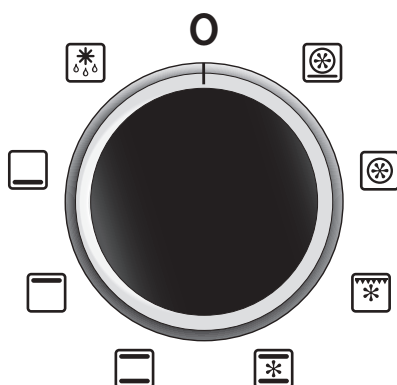

Duo	Fläktugn	Grillning med fläkt	Fläktassisterad	Konventionell	Bryning	Bottenvärme	Upptining

Du kan läsa mer om dessa funktioner i den fullständiga bruksanvisningen.

Användning av multifunktionsugn

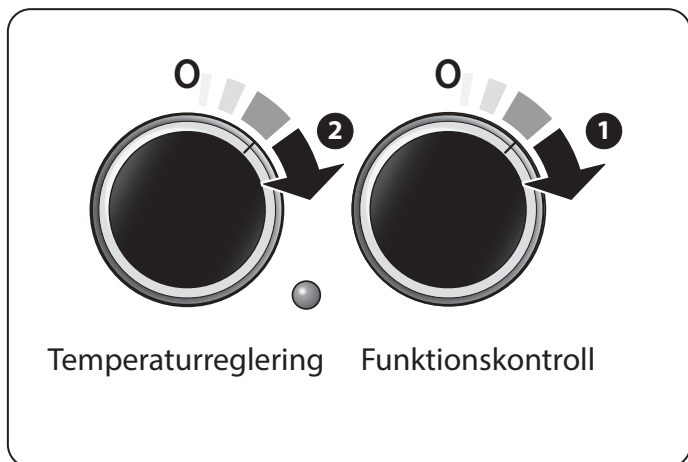

Användning av fläktugn

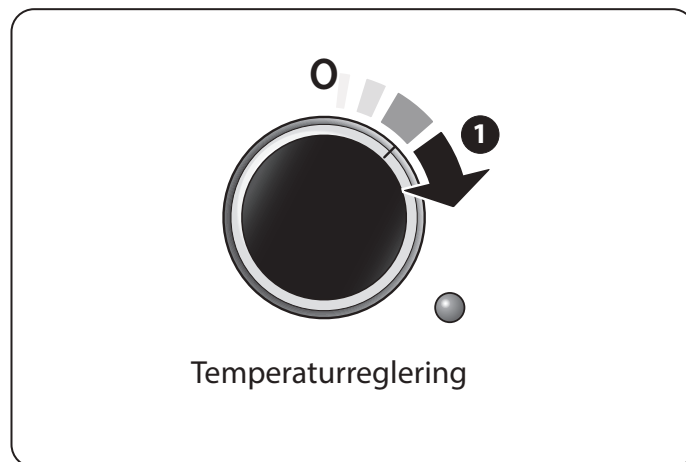

Montering av ugnshyllor

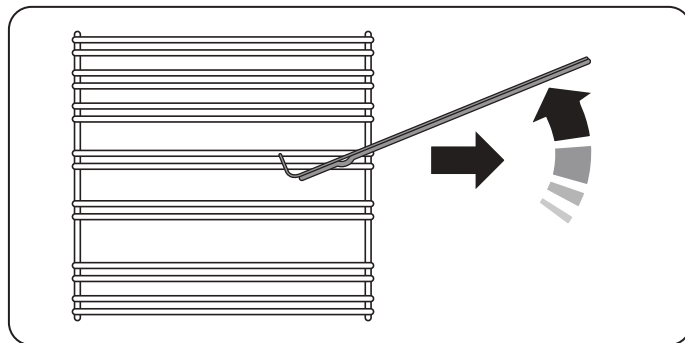
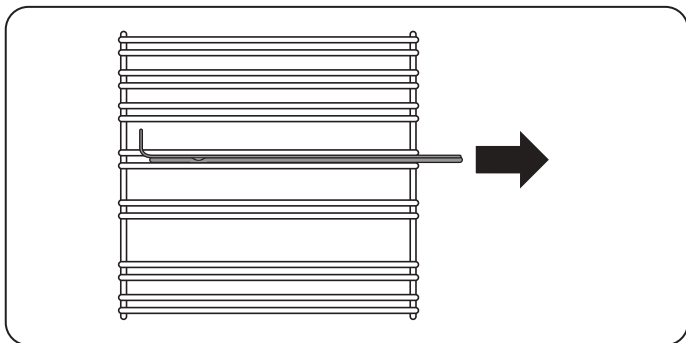

Montering av ugnens teleskophyllor

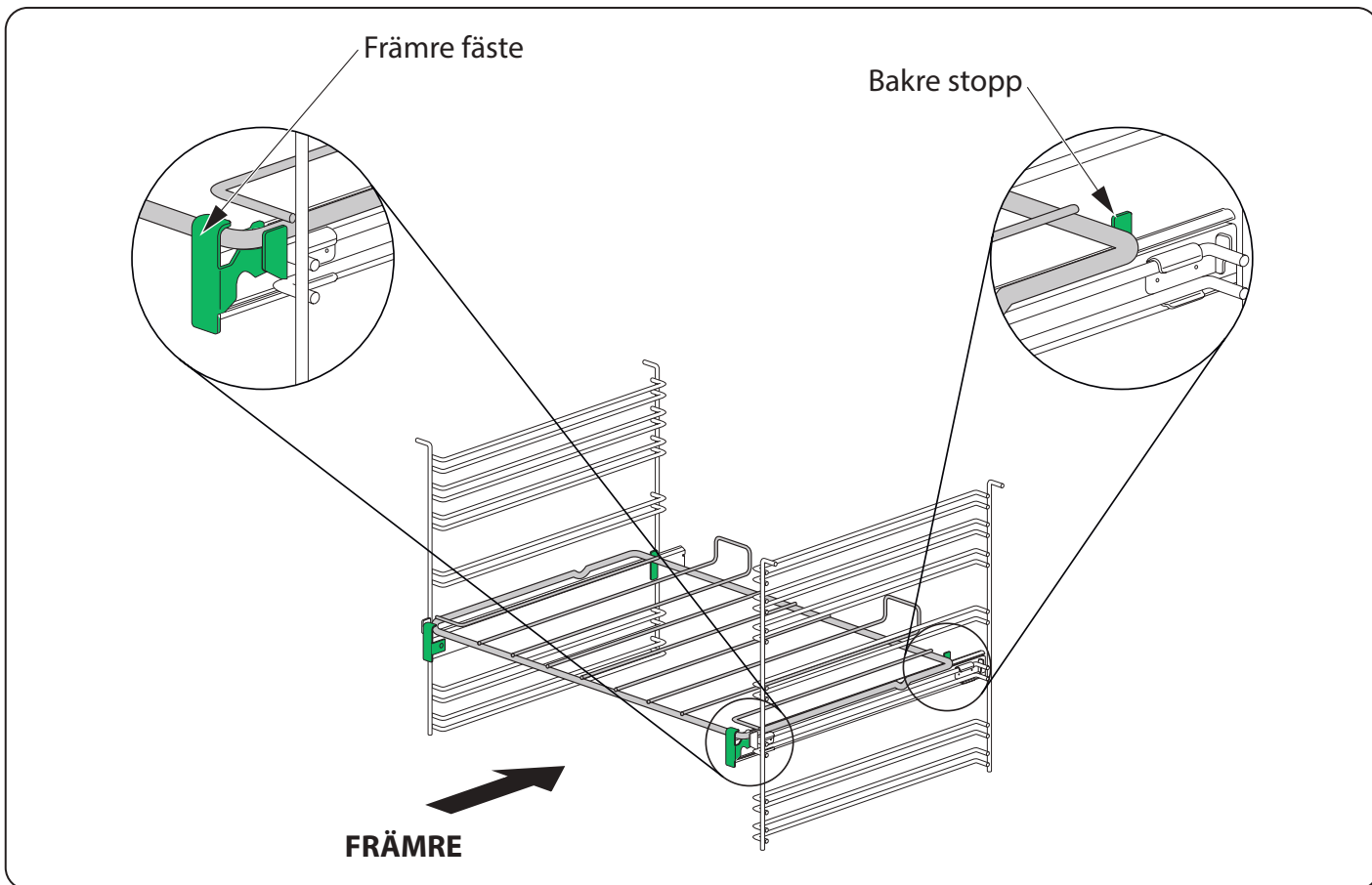
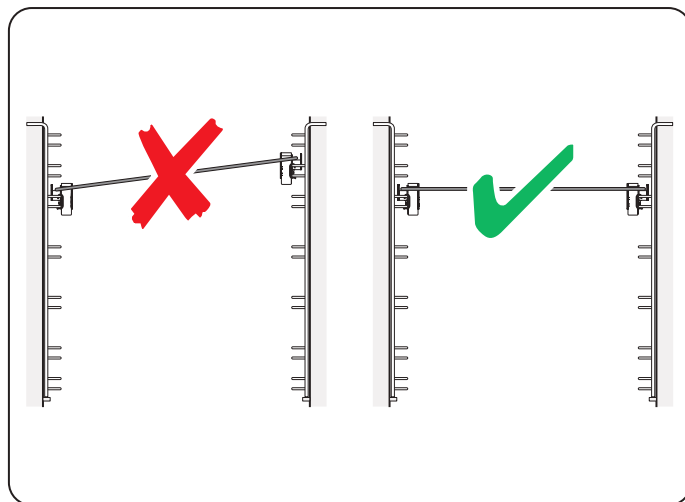
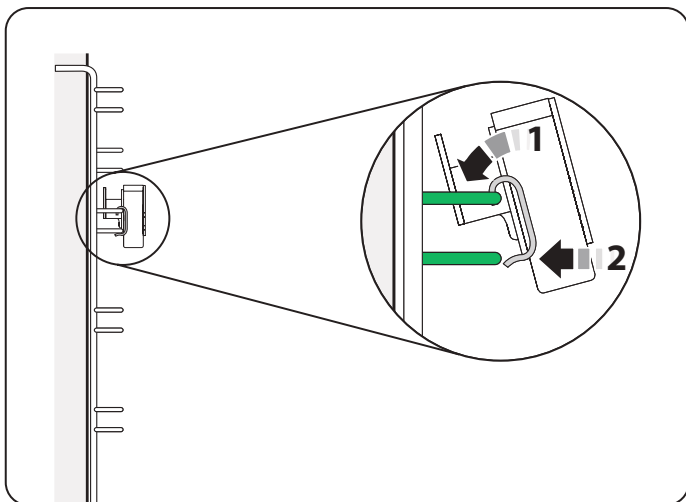

Enkelt utrymme – Energisparpanel

Sätt in energisparpanelen

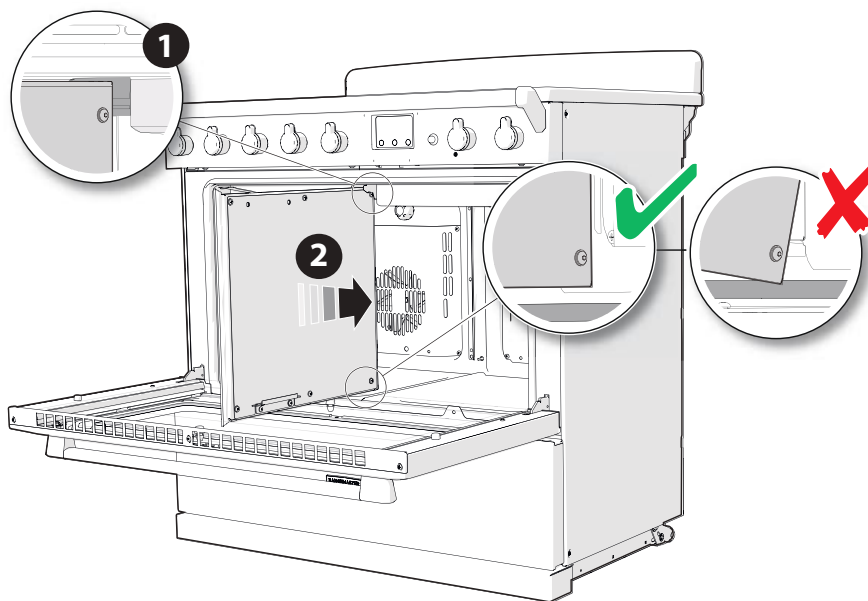

Stoppa in gummitätningen längs den inre glaskanten.

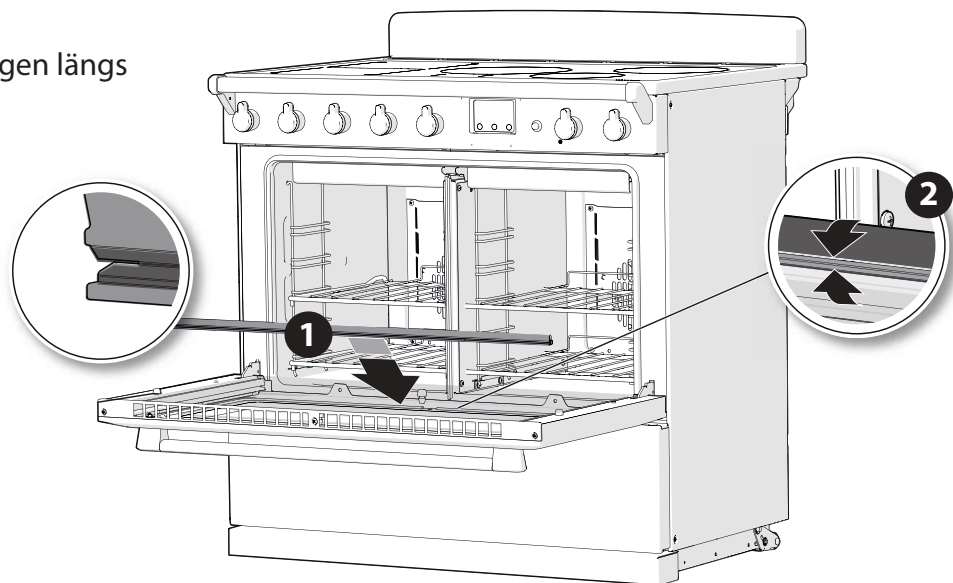

Energisparpanel

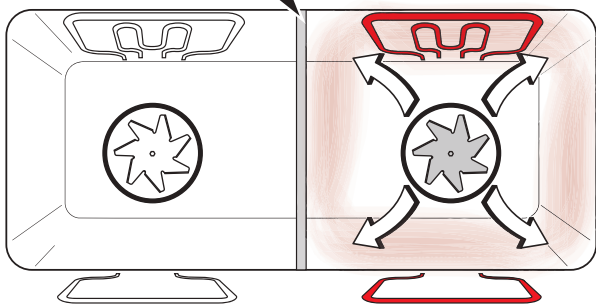

Ta bort energisparpanelen

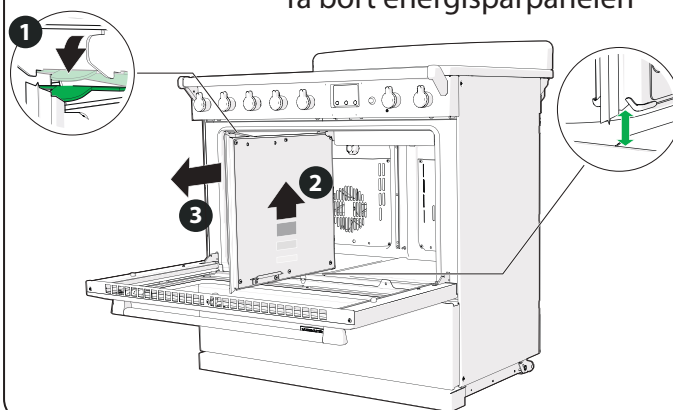

Häll - Utförande och hantering

Dubbla bränslen

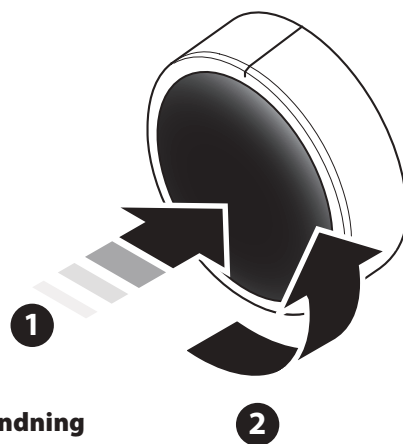
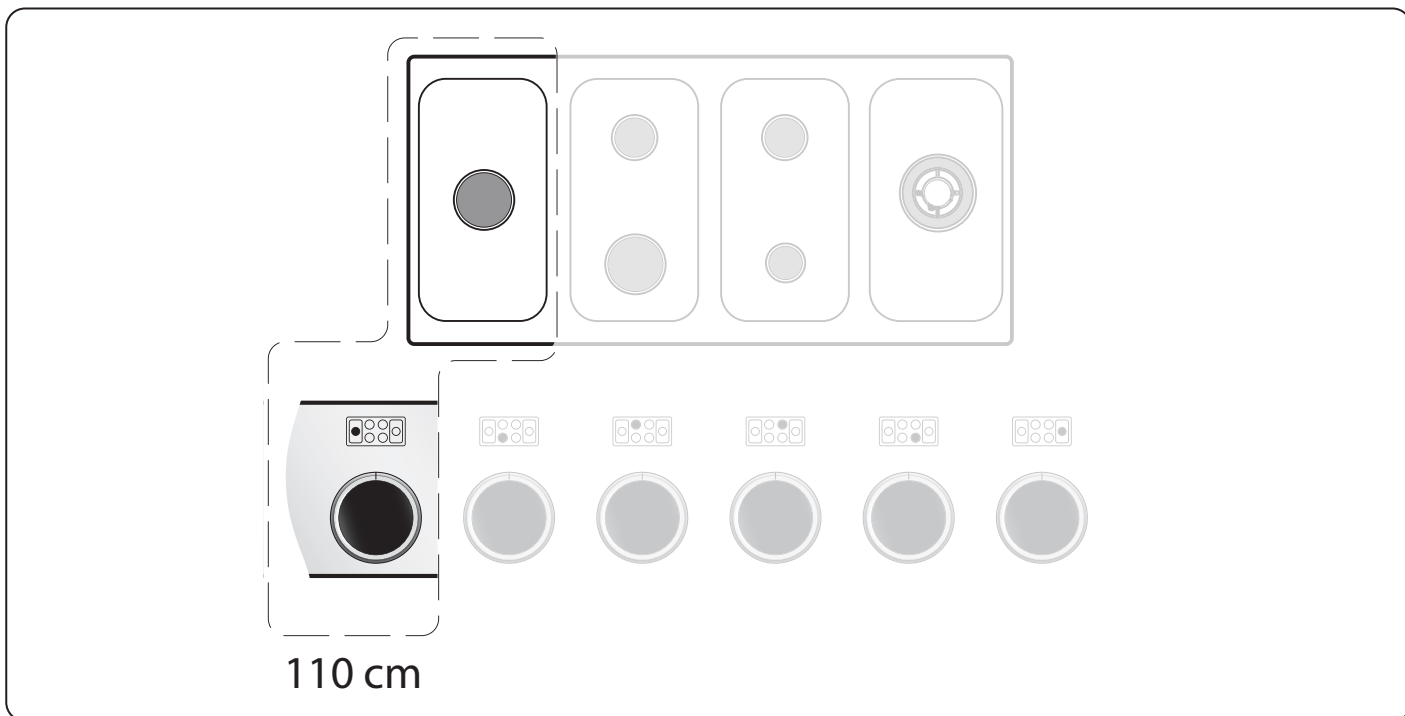

Enhandstänning

110 cm-modeller med multizon

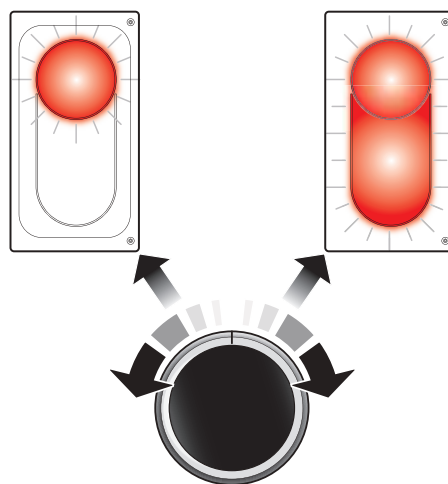
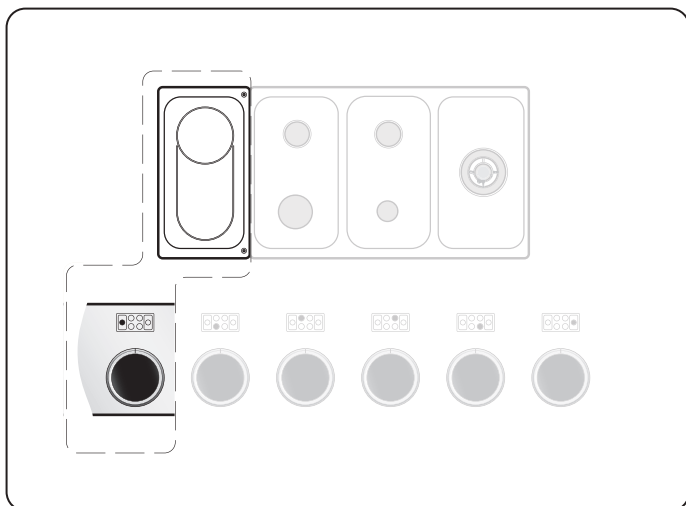

Häll – Utförande och hantering

Induktion för Kitchener

Kontroll av grytor

Använd en zon på 1,85 kW (se bruksanvisningen för olika zonzvärden).

Fyll en gryta utan lock med 1/2 liter rumstempererat vatten (grytans diameter bör inte vara större än zonen yttre cirkel).

Kör zonen på effektnivå 9.

Vattnet ska koka inom 3½ minuter.

Längre koktider tyder på att grytan inte är lämplig vilket kan leda till komponentfel alltför tidigt.

Utförande med induction

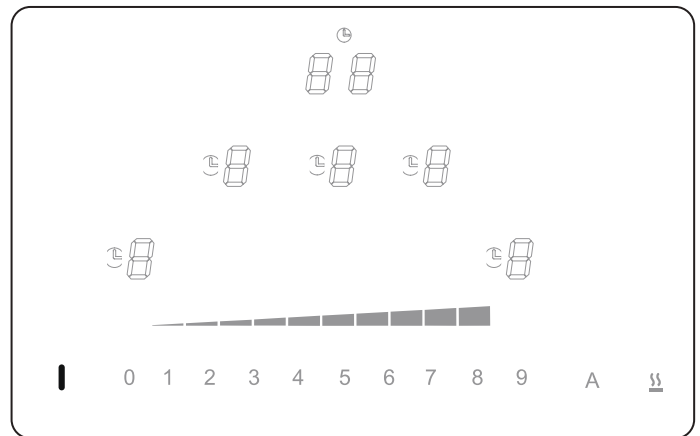
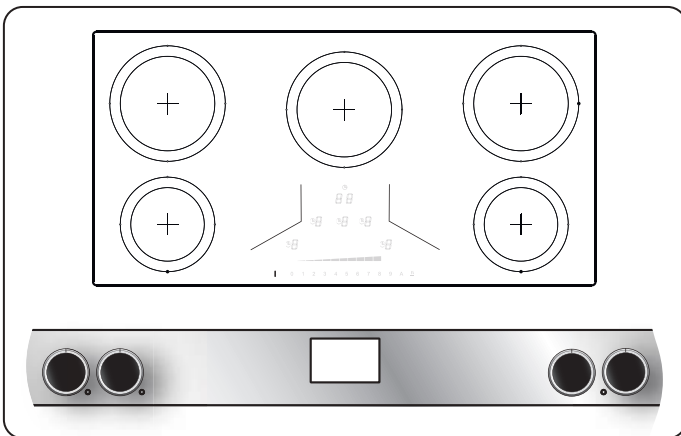

Induktionssymboler

För att välja funktioner, tryck på respektive symboler på skärmpanelen.

Driftssekvens [Tryck Tryck och svep]	Visning	Funktion
	CL	• Slå på och timer klar
0 → ∞	- ∞ blinkar — 0 1	• Lågtemperaturinställningar - Endast nivå 1
0 → A	A	• Automatiskt uppvärmning (om tillgängligt)
CL → 0 → 0 1 2 3	99	• Timerinställning, med ett maximum på 99 minuter. • 1-minuters timer; nedräkning från 59 sekunder.

Visning	Funktion
0...9 0 1 2 3 4 5 6 7 8 9	• Temperaturinställningar - Nivåer 1 till 9
P	• Inställning för effektförstärkning
H	• Indikator för restvärme
U	• Ingen gryta upptäckt
0	• Kastrull/Panna upptäckt på den respektive zonen
E #	• Begäran om servicesupport
ER	
EH	
Er	

Häll – Utförande och hantering

Induktion för Professional+ / Professional Deluxe

Kontroll av grytor

1. Placera det på de relevanta kokzonerna för bedömning.
2. Tryck på och tryck sedan på 3 gånger.
3. Tryck på .

Zonen börjar gradera potten och den blinkande sekvensen visas.

När kontrollen är klar visar displayen:-

Betyg 3 [] betyder Utmärkt; optimal matlagningseffektivitet.

Betyg 2 [] betyder Genomsnittlig; reducerad matlagningseffektivitet.

Betyg 1 [] betyder Dålig.

Utförande med induktion

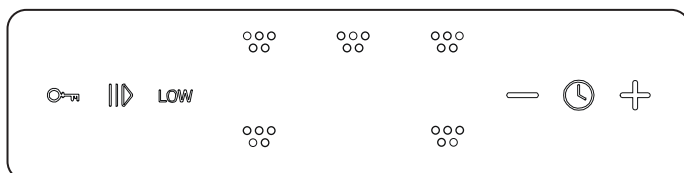
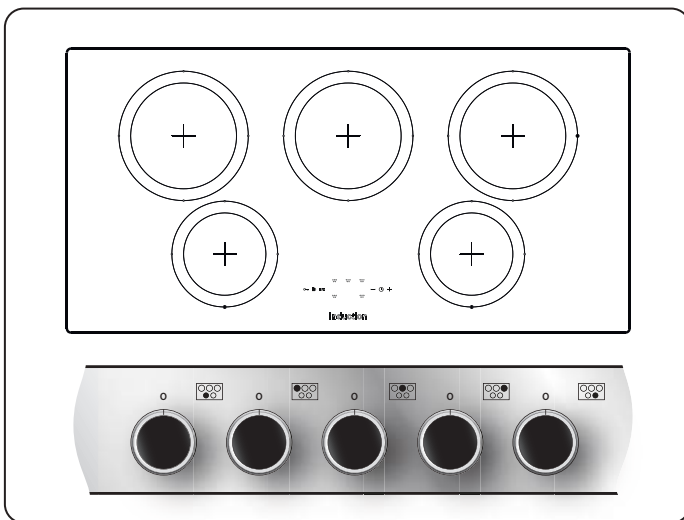

Utförande med bryggzon

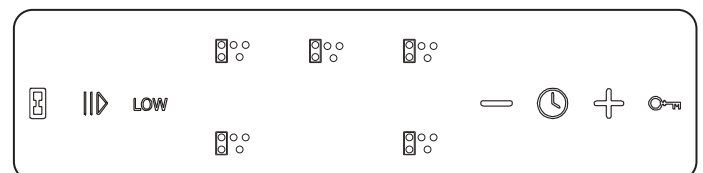
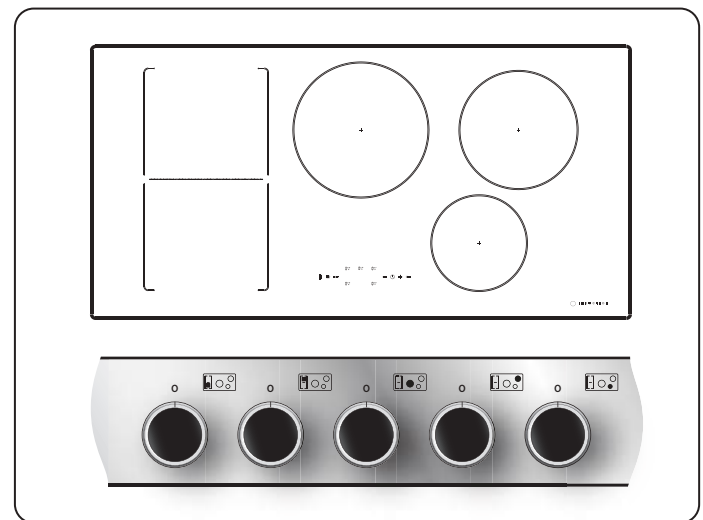

Induktionssymboler

För att välja funktioner, tryck på respektive symboler på skärmpanelen.

Operationssekvens [Tryck]	Visning	Funktion
	L	• Barnlås
	B	• Aktivera/Deaktivera bryggfunktion
		• Pausa alla kokzoner
→	TIMER 99	• Tidinställning, med max 99 minuter
LOW →	LOW 1...2...3	• Inställningar för låg temperatur - endast Nivå 1 till 3

Visning	Funktion
1...9	• Temperaturinställningar - Nivåer 1 till 9
P	• Inställning för effektförstärkning
H	• Indikator för restvärme
t _i	• Begäran om servicesupport
U	• Ingen gryta upptäckt

Häll – Utförande och hantering

Induktion

Utförande med induktion

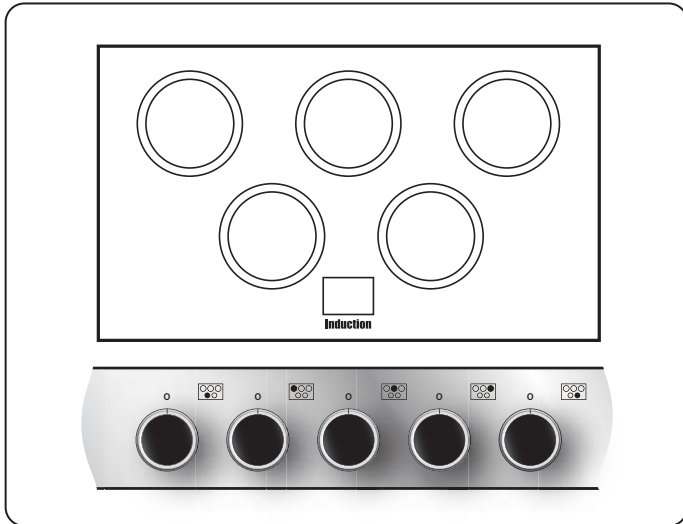

Utförande med bryggzon

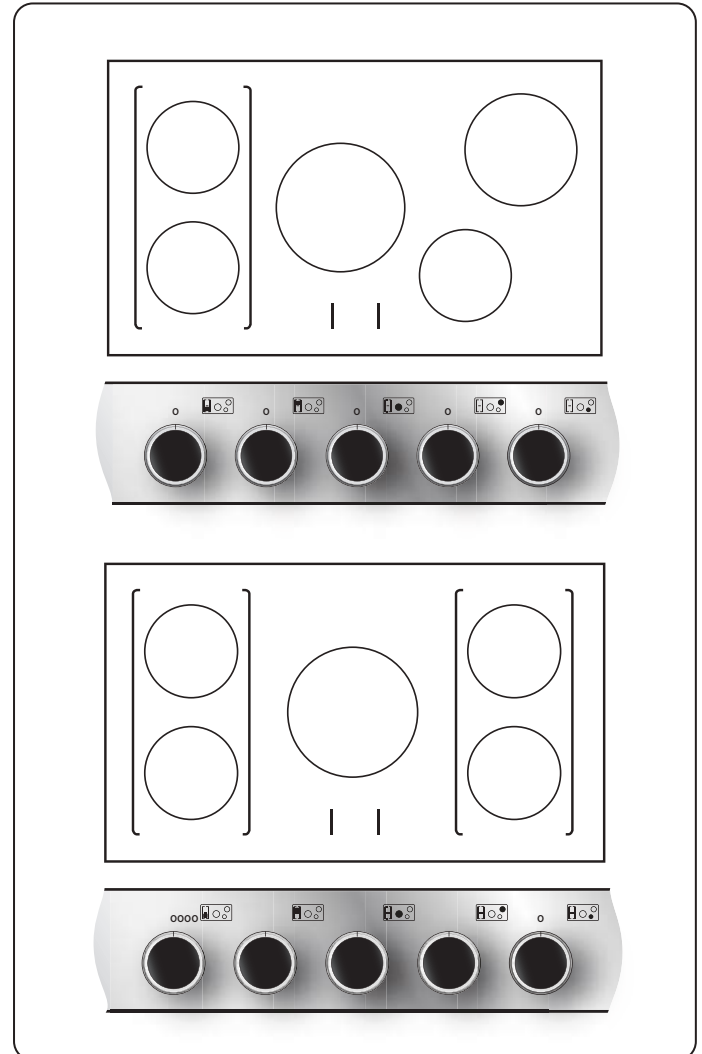

Kontroll av grytor

Använd en zon på 1,85 kW (se bruksanvisningen för olika zonzvärden).

Fyll en gryta utan lock med 1/2 liter rumstempererat vatten (grytans diameter bör inte vara större än zonzens yttre cirkel).

Kör zonen på effektnivå 9.

Vattnet ska koka inom 3½ minuter.

Längre kottider tyder på att grytan inte är lämplig vilket kan leda till komponentfel alltför tidigt.

Häll – Utförande och hantering

Induktionssymboler

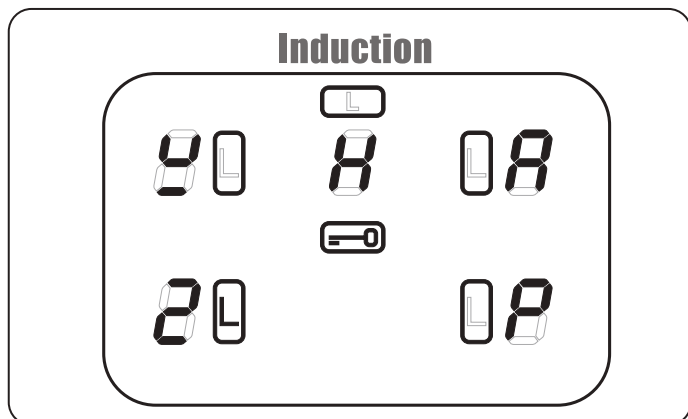

U	Ingen gryta upptäckt
H	Indikator för restvärme
R	Automatisk uppvärmning – i förekommande fall
	Barnlås
	Lågtemperaturinställning 1 - Smälta: 2 - Sjuda:
	Lågtemperaturinställning 1 - Smälta: 2 - Hålla Varm: 3 - Sjuda:
1...9	Temperaturinställningar - Nivåer 1 till 9
P	Inställning för effektförstärkning
E 2	Temperaturen på grytan eller glaset är för hög. Låt systemet svalna.
E 3	Olämpat kokkärl; gör pannprestandatestet eller prova ett annat kokkärl.
E_r-E	Utför en manuell återställning. Kontakta kundservice om problemet kvarstår.

Häll – Utförande och hantering

Keramisk

110 cm-utförande

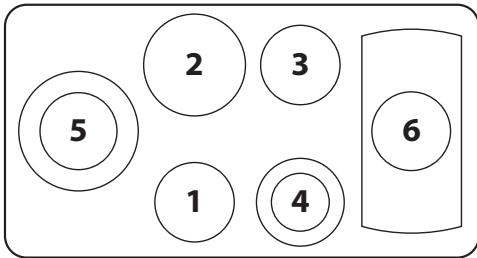

90 cm and 100 cm-utförande

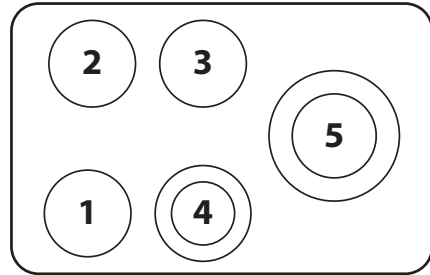

Positioner för hällar med dubbla element – 4 och 5

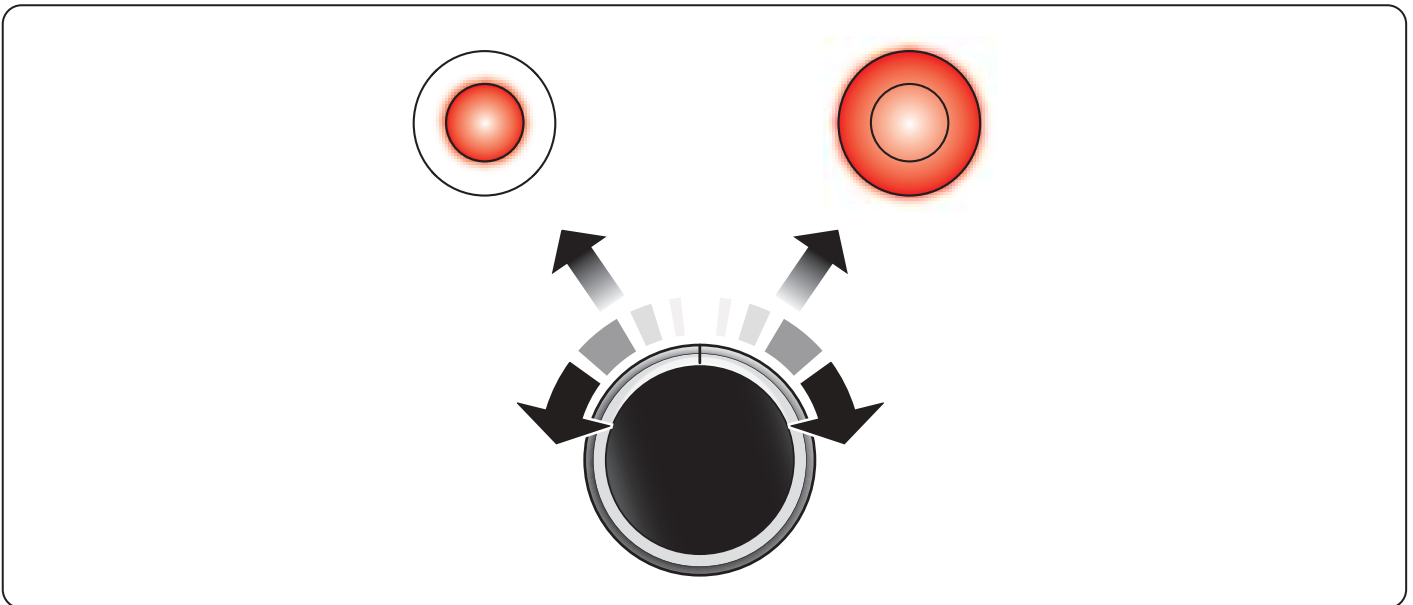

Varmhållningszon/Tillagningszon – 6

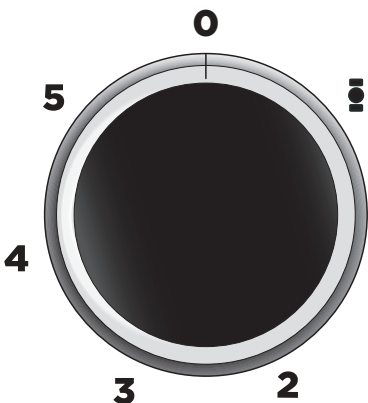

	1	2	3	4	5
Komplett varmhållningszon	Låg värme	Medelhög värme – smältning av smör	Medelhög värme – sjudning	Hög värme	Mycket hög värme

Skötsel av utrustningen

⚠ Isolera elförsörjningen innan du genomför en grundlig rengöring. Låt spisen svalna.

Alla spisdelar kan rengöras med såpvatten – **men se till att inget vatten läcker in i apparaten.**

En fullständig lista över rekommenderad rengöring för varje del av spisen hittar du i bruksanvisningen.

- Regelbunden rengöring rekommenderas. För lättare rengöring, torka bort eventuellt spill omedelbart.
- Alla spisdelar kan rengöras med såpvatten och en mjuk torkduk eller E-dukar.
- Skurkräm och nylonskrubbsvampar kan användas på mer envisa fläckar som inte kan tas bort med såpvatten eller mjuka torkdukar
- Särskilda ugnrensmedel som lämpar sig för emalj (till exempel Oven Pride) kan användas på ugnsutrymmets botten och baksida samt på andra emaljerade ytor. Låt inte dessa kemi kemikalier komma i kontakt med ugnselementen eller katalytiska skydd.
- Använd inte lösningsmedel, tvättsoda, biologiska pulver, blekmedel, klorbaserade blekmedel, grova slipmedel eller salt.
- Använd inte stålull (trådull), ugnsslipdynor eller andra material som kan repa ytorna.
- En skrapa avsedd för hällar kan användas på induktionshällar och keramiska hällar för envisa och fastbrända rester.

Diskmaskinssäkra delar och delar som inte får diskas i maskin

Diskmaskinssäkra delar	Delar som inte får diskas i maskin
Ugnshyllor	Sidoskenor
Handyrack	Sidoskydd
Rack för tallriksvärmning	Brännarhuvuden
Grillpanna	Utdragbara ugnsskenor
Ugnspanna (placeras på Handyrack)	Utdragbara grillskenor
Brännarlock	Reglage
Stekbord (ej induktionsstekbord)	Induktionsstekbord
Grytstöd	
Wokhållare	

Testrecept

Bakning

I enlighet med EN60350-1

Denna tillagningstabell har producerats för testinstitut för att underlätta apparattester.

* Förvärmd

**Fatless Sponge

Maträtt	Bakplåt/Bakform	Ugnsfunktion	Nivå	Temperatur	Tid
Shortbread	Bakplåt 34 cm x 34 cm	Varmluftsgugn	3	160°C*	12 minuter
Shortbread	Bakplåt 34 cm x 34 cm	Traditionell ugn	3	170°C*	12 minuter
Shortbread, 2 bakplåtar på 2 nivåer	Bakplåt 34 cm x 34 cm	Varmluftsgugn	2 & 4	160°C*	12 minuter
Shortbread, 3 bakplåtar på 3 nivåer	Bakplåt 34 cm x 34 cm	Varmluftsgugn	1, 3 & 5	160°C*	12 minuter
Småkakor	Bakplåt 34 cm x 34 cm- 16 kakor per bakplåt	Varmluftsgugn	3	160°C*	30 minuter
Småkakor	Bakplåt 34 cm x 34 cm- 16 kakor per bakplåt	Traditionell ugn	2	180°C*	30 minuter
Småkakor, 2 bakplåtar på 2 nivåer	Bakplåt 34 cm x 34 cm- 16 kakor per bakplåt	Varmluftsgugn	2 & 4	160°C*	30 minuter
Småkakor, 3 bakplåtar på 3 nivåer	Bakplåt 34 cm x 34 cm- 16 kakor per bakplåt	Varmluftsgugn	1, 3 & 5	160°C*	30 minuter
Fettfri sockerkaka**	Springform 26 cm	Varmluftsgugn	3	170°C*	35 minuter
Fettfri sockerkaka**	Springform 26 cm	Traditionell ugn	2	180°C*	35 minuter
Fettfri sockerkaka** , 2 nivåer	Springform 26 cm	Varmluftsgugn	2 & 4	160°C*	30 minuter
Äppelpaj	Bakplåt 20 cm	Varmluftsgugn	3	200°C*	45 minuter
Äppelpaj	Bakplåt 20 cm	Traditionell ugn	2	210°C*	45 minuter
Äppelpaj, 2 nivåer	Bakplåt 20 cm	Varmluftsgugn	2 & 4	200°C*	45 minuter

Grill * Förvärmd i 3 minuter **Vänd maten mellan halva och två tredjedelar av tillagningstiden



Ugnshyllor

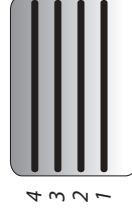

Grillhyllor

Maträtt	Bakplåt/Bakform	Nivå inom grillen	Hyllans position	Underläggets position	Tid
Rostat bröd	Grillpanna och underlägg	3*	3	Högst	3-4 minuter**
Nötköttburgare	Grillpanna och underlägg	3*	3	Högst	15 minuter**

Batterie de cuisine et accessoires.
Ovenwaren en accessoires.

Kochgeschirr und Zubehör.
Kärl och tillbehör.



Pour vous permettre de tirer le meilleur parti de votre nouvelle cuisinière, nous avons développé une gamme d'ustensiles de cuisine exclusifs, conçus pour des performances et une longévité optimales.

Damit Sie das Beste aus Ihrem neuen Herd herausholen können, haben wir ein exklusives Kochgeschirr-Sortiment für optimale Leistung und Langlebigkeit entwickelt.

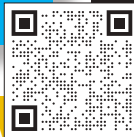

Om ervoor te zorgen dat u het meeste uit uw nieuwe fornuis haalt, hebben we een exclusief assortiment keukengerei ontwikkeld dat ontworpen is voor optimale prestaties en een lange levensduur.

För att du ska få ut mesta möjliga från din nya spis har vi utvecklat en särskild serie kärl och tillbehör som ger optimala prestanda och lång brukningstid.

Assistance complémentaire.
Verdere ondersteuning

Weitere Unterstützung.
Ytterligare support





Registered Office: c/o Aga Rangemaster,
Meadow Lane, Long Eaton, Nottingham, NG10 2GD

CE
UK
CA

08-000043-02a