



Dear customer,
We would like to thank you for welcoming
a new Jamo Studio7 speakers into your home.

Our designers & engineers have worked tirelessly
to bring you a rare combination of both aesthetics
and performance.

We hope you enjoy listening to it as much as
we did in making it.

Best regards,
The Jamo team

Jamo®

EST. 1968

Jamo STUDIO7 SERIES

BEFORE YOU START

Some Jamo speakers have feet and other accessories that may need to be installed prior to use.

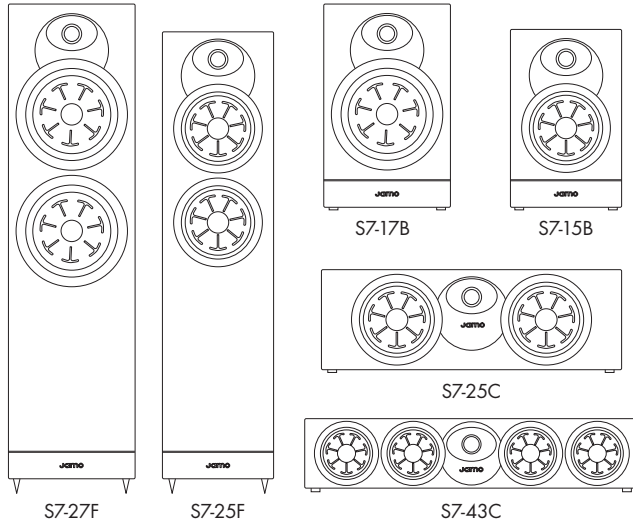

FLOORSTANDING SPEAKERS (METAL SPIKES)

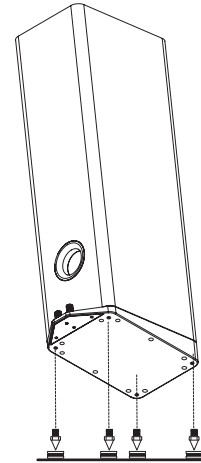

OTHER SPEAKERS (RUBBER FEET)

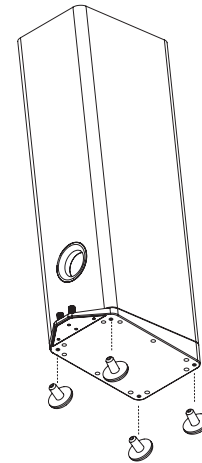

ROOM PLACEMENT

Left and Right Main Channel Speakers - For optimum performance, Jamo suggests placing your speakers 6 to 15 feet (1.8 m to 4.6 m) apart and at least 24" from the walls. They may also be toed-in slightly for better stereo imaging. The listening position should be about 1 to 1.5 times the distance separating the speakers. Refer to Figures 1 and 3 for connection and placement.

Center Channel Speakers - Center channel speakers are designed to place dialogue and primary sounds so that they appear to come from the video screen. The speakers should therefore be placed as close to the screen as possible, preferably below the screen. Refer to Figures 1, 2 and 3 for connection and placement.

Surround Channel - The surrounds should be adjacent to the listening position. Another option would be behind the listening position. The final surround speaker placement depends on your room's characteristics. They are designed to recreate the sense of space and ambience. Refer to Figures 1, 3 and 4 for connection and placement.

CONNECTION

Conventional Connection - Using minimum 16 gauge speaker wire, connect the RED "positive" (+) terminal of the LEFT speaker to the RED "positive" (+) terminal of your amplifier's LEFT channel. Connect the BLACK "negative" (-) terminal of the LEFT speaker to the BLACK "negative" (-) terminal of your amplifier's LEFT channel. Repeat the above procedure for connecting all remaining speakers to the appropriate amplifier channels. Refer to Figure 3. Make sure that no bare wires from any of the connections touch any other terminals as this could cause a short circuit and damage your equipment.

Amplifier Requirements - Jamo Studio7 speakers are efficient and rated as a 4 ohm load. For optimum performance, please ensure your amplifier is rated for use into a 4 ohm. Your Jamo speakers are capable of very high acoustic output at low distortion levels, so please exercise caution when listening at high levels over long periods as this could lead to hearing damage. Overdriving your amplifier could also damage your speakers. Check with your dealer or amplifier manual to make sure your particular amplifier is best suited to your application.

FIGURE 1
SPEAKER PLACEMENT IN LISTENING AREA

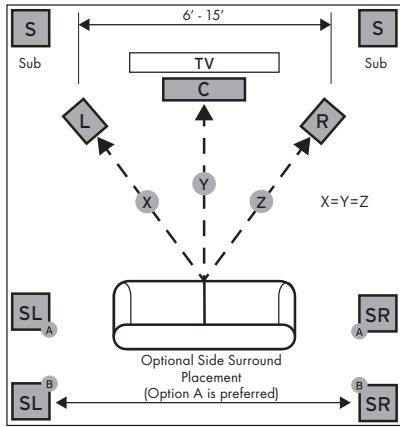

FIGURE 3
STANDARD CONNECTIONS

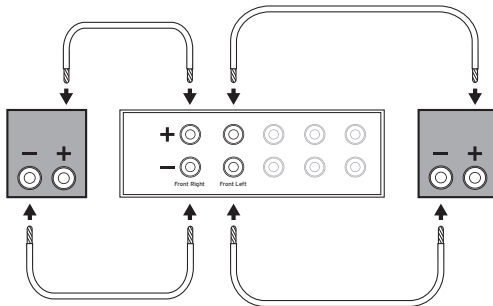

FIGURE 2
CENTER CHANNEL

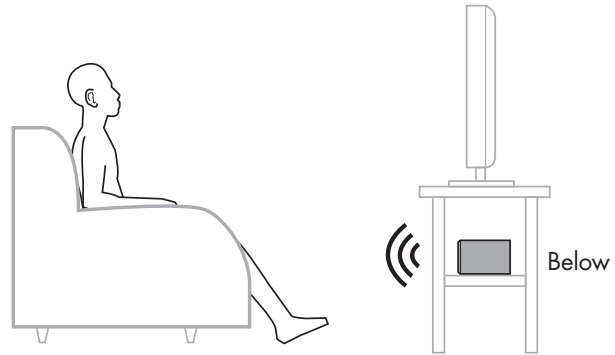
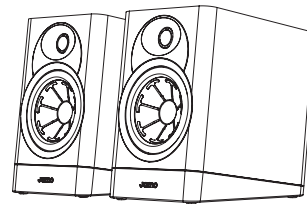
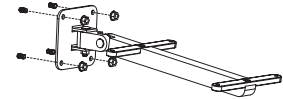

FIGURE 4
WALL MOUNTING OPTION FOR SURROUND SPEAKERS (S7-15B ONLY)



(Optional - Brackets not included in the box)



CAUTION!
Do not use keyhole
for ceiling or wall mounting!

WALL MOUNTING OPTION FOR S7-15B

(OPTIONAL / BRACKETS NOT INCLUDED IN THE BOX)

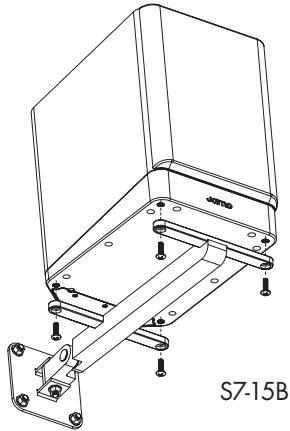

CARE AND CLEANING

The only thing you should ever need to do to your speakers is dust them occasionally. Never apply any abrasive or solvent-based cleaner or any harsh detergent. You can clean the grilles with the brush attachment of a vacuum cleaner.

PRODUCT REGISTRATION

Register your product online at www.jamo.com.

- Keep up-to-date on new products and promotions.
- Your personal information will never be resold.
- This registration information is not used for warranty purposes.
Please retain your receipt for warranty claims.

Jamo STUDIO7 SERIES

FRENCH

AVANT DE COMMENCER

Certaines enceintes Jamo ont des pieds et d'autres accessoires qu'il pourra falloir installer avant l'utilisation.

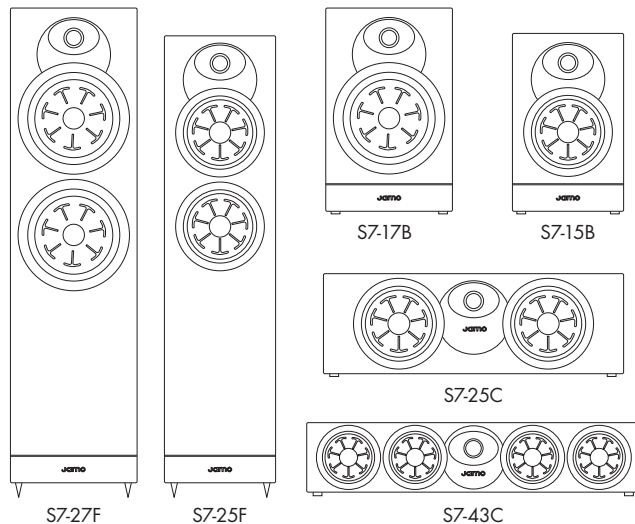

ENCEINTE COLONNE (POINTES EN MÉTAL)

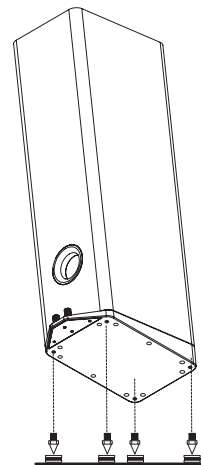

AUTRES ENCEINTE (PIEDS EN CAOUTCHOUC)

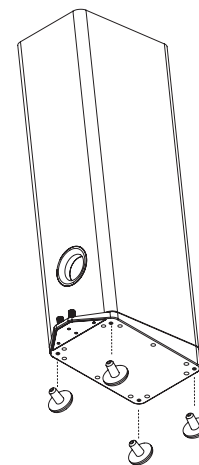

POSITIONNEMENT DANS LA PIÈCE

Enceintes principales gauche et droite - Pour obtenir les meilleurs résultats, Jamo suggère de placer vos enceintes à une distance de 1,80 m à 4,60 m l'une de l'autre, et à au moins 60 cm des murs. Elles peuvent également être légèrement tournées l'une vers l'autre pour une meilleure restitution stéréo. La position d'écoute devrait se situer à environ 1 à 1,5 fois la distance séparant les enceintes. Reportez-vous aux schémas 1 et 3 pour le branchement et le positionnement.

Enceintes centrales - Les enceintes centrales sont conçues pour diffuser les dialogues et les sons principaux de manière qu'ils semblent provenir de l'écran vidéo. Les enceintes devraient par conséquent être placées aussi près que possible de l'écran et de préférence directement en dessous de l'écran. Reportez-vous aux schémas 1, 2 et 3 pour le branchement et le positionnement.

Enceintes surround - Les enceintes surround devraient être adjacentes à la position d'écoute. Une autre option consiste à les installer derrière la position d'écoute. Le positionnement des enceintes surround dépend des caractéristiques de votre pièce. Elles sont conçues pour recréer la sensation d'espace et d'ambiance. Reportez-vous aux schémas 1, 3 et 4 pour le branchement et le positionnement.

BRANCHEMENT

Branchement conventionnel - En utilisant du câble d'enceinte d'un diamètre minimum de 1,3 mm² (16 AWG), reliez la borne « positive » (+) ROUGE de l'enceinte de GAUCHE à la borne « positive » (+) ROUGE de la voie de GAUCHE de votre amplificateur. Reliez la borne « négative » (-) NOIRE de l'enceinte de GAUCHE à la borne « négative » (-) NOIRE de la voie de GAUCHE de votre amplificateur. Répétez cette procédure pour brancher toutes les enceintes restantes aux voies appropriées de l'amplificateur. Reportez-vous au schéma 3. Veillez à ce qu'aucun des fils dénudés, utilisés pour les branchements, ne touche une autre borne, étant donné que cela pourrait provoquer un court-circuit et endommager votre équipement.

Exigences relatives à l'amplificateur - Les enceintes Jamo Studio7 ont un haut rendement et ont une charge nominale de 4 ohms. Pour des performances optimales, assurez-vous que votre amplificateur est conçu pour être utilisé avec une charge de 4 ohms. Vos enceintes Jamo sont capables d'atteindre de forts volumes sonores avec de faibles niveaux de distorsion. Soyez vigilant lorsque vous écoutez à fort volume pendant de longues périodes, car cela pourrait entraîner des lésions auditives.

SCHÉMA 1 POSITIONNEMENT DES ENCEINTES DANS LA ZONE D'ÉCOUTE



SCHÉMA 3 BRANCHEMENTS STANDARD



SCHÉMA 2 VOIE CENTRALE

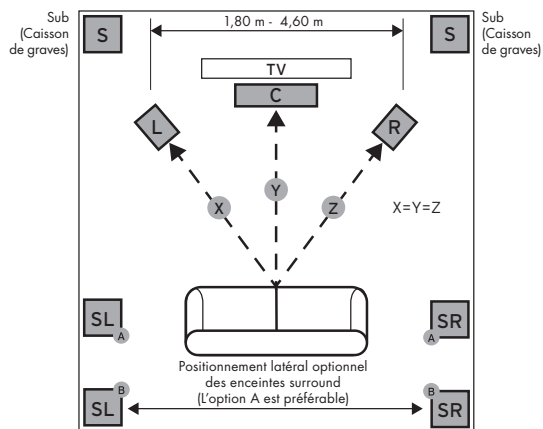

SCHÉMA 4 FIXATION MURALE DES ENCEINTES SURROUND S7-15B

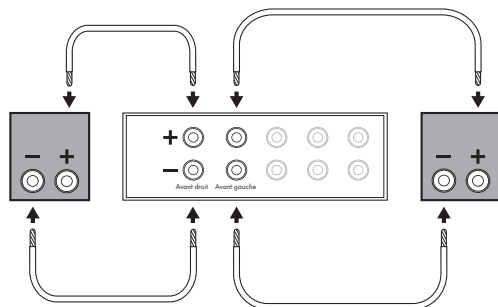

(En option / Les supports muraux ne sont pas inclus dans le carton)

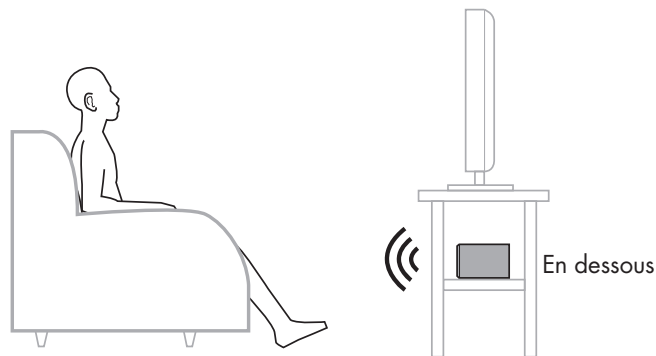
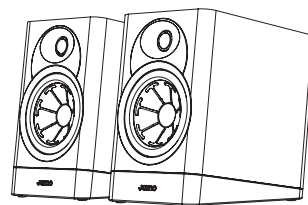
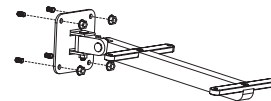

ATTENTION!
N'utilisez pas les pas de vis pour une installation murale ou au plafond!

INSTALLATION MURALE DES S7-15B

(EN OPTION / LES SUPPORTS MURAUX NE SONT PAS INCLUS)

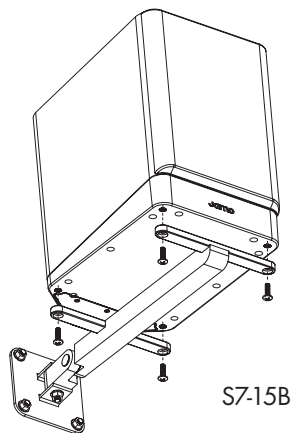

S7-15B

ENTRETIEN ET NETTOYAGE

La seule chose que vous devriez avoir besoin de faire pour vos enceintes est de les épousseter occasionnellement. N'utilisez jamais de produits de nettoyage abrasifs ou à base de solvant, ni aucun détergent agressif. Vous pouvez nettoyer les grilles avec la brosse d'un aspirateur.

Jamo STUDIO7 SERIES

SPANISH

ANTES DE EMPEZAR

Algunos altavoces Jamo tienen patas y otros accesorios que puede ser necesario instalar antes de usarlos.

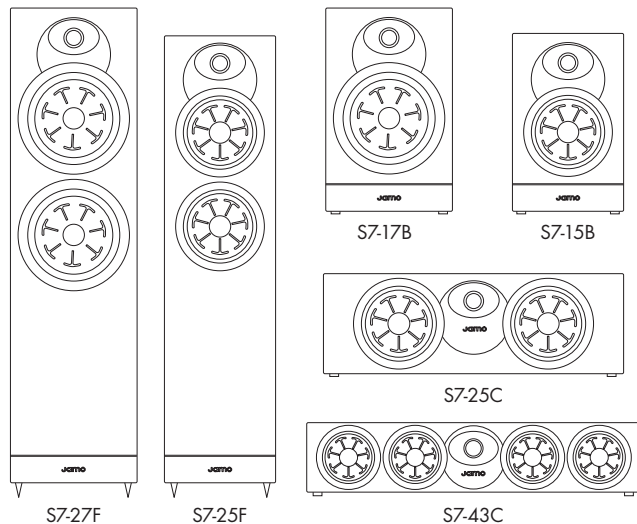

ALTAVOCES DE PIE (PUNTAS METÁLICAS)

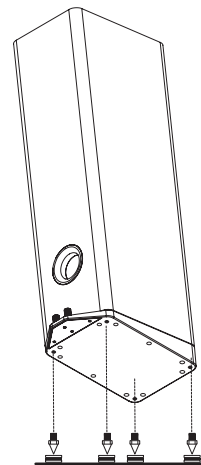

OTROS ALTAVOCES (PIES DE GOMA)

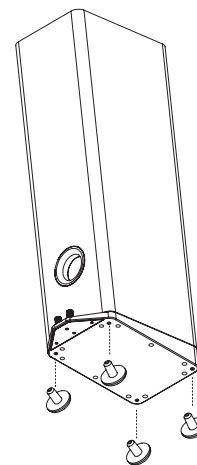

UBICACIÓN EN LA SALA

Altavoces de canal principal izquierdo y derecho - Para obtener la mejor fidelidad, Jamo sugiere separar los altavoces de 1,8 m a 4,6 m y ubicarlos a un mínimo de 60 cm de la pared de atrás y las paredes laterales. También se pueden orientar un poco hacia adentro para obtener una mejor imagen estereofónica. La posición del oyente debe estar entre 1 y 1,5 veces la distancia que separa los altavoces. En las figuras 1 y 3 hay detalles de conexión y ubicación.

Altavoces de canal central - Los altavoces de canal central han sido diseñados para ubicar el diálogo y los sonidos principales de manera que parezca que provienen de la pantalla de video. Por lo tanto, se deben ubicar lo más cerca posible de la pantalla, de preferencia directamente debajo de la pantalla. En las figuras 1, 2 y 3 hay detalles de conexión y ubicación.

Altavoces surround - Los altavoces surround deben estar adyacentes a la posición de escucha. Otra opción es instalarlos detrás de la posición de escucha. La colocación de los altavoces de sonido envolvente depende de las características de la habitación. Son están diseñados para recrear la sensación de espacio y ambiente. Consulte las figuras 1, 3 y 4 para la conexión y la colocación.

CONEXIONES

Conexión convencional - Con cable de altavoz calibre 1,3 mm² (16AWG) o mayor, conecte la terminal ROJA "positiva" (+) del altavoz IZQUIERDO a la terminal ROJA "positiva" (+) del canal IZQUIERDO de su amplificador. Conecte la terminal NEGRA "negativa" (-) del altavoz IZQUIERDO a la terminal NEGRA "negativa" (-) del canal IZQUIERDO de su amplificador. Repita este procedimiento para conectar los otros altavoces a los canales correspondientes del amplificador. Consulte la figura 3. Asegúrese de que en ninguna de las conexiones haya cables sin aislamiento que toquen otras terminales, pues esto podría causar un cortocircuito y dañar el equipo.

Requisitos del amplificador - Los altavoces Jamo Studio7 son eficientes y están clasificados como una carga de 4 ohmios. Para obtener un rendimiento óptimo, asegúrese de que su amplificador está preparado para utilizarlo con una carga de 4 ohmios. Sus altavoces Jamo son capaces de una salida acústica muy alta con bajos niveles de distorsión, por lo que le rogamos que tenga cuidado cuando escuche a niveles altos durante periodos prolongados, ya que esto podría provocar daños auditivos.

FIGURA 1
COLOCACIÓN DE LOS ALTAVOCES EN LA ZONA DE ESCUCHA



FIGURA 3
CONEXIONES ESTÁNDAR



FIGURA 2
CANAL CENTRAL

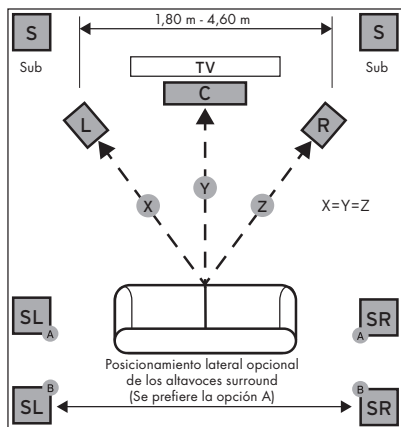

FIGURA 4
MONTAJE DE LOS ALTAVOCES SURROUND EN LA PARED S7-15B

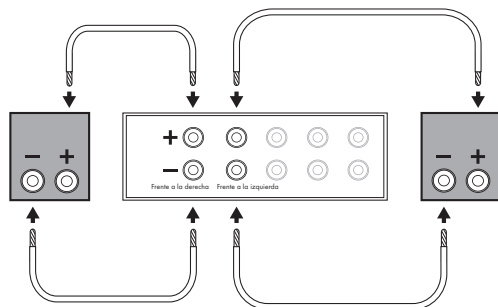

(Opcional / Soportes no incluidos en la caja)

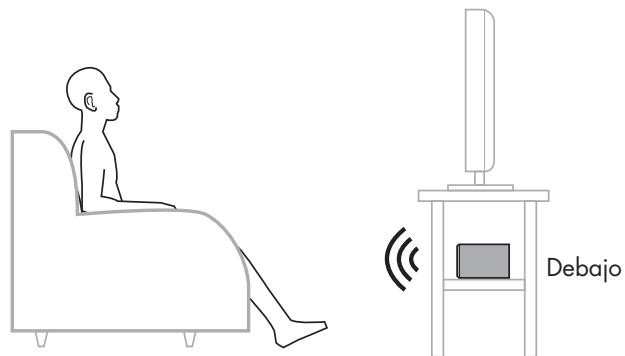
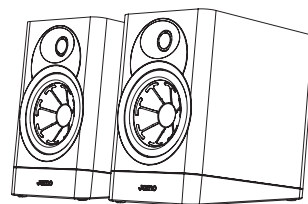
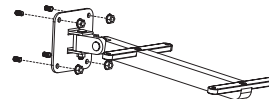

¡PRECAUCIÓN!
¡No utilice el orificio en forma de ojo de cerradura para realizar el montaje en la pared o en el techo!

MONTAJE EN PARED DEL S7-15B

(OPCIONAL / SOPORTES NO INCLUIDOS EN LA CAJA)

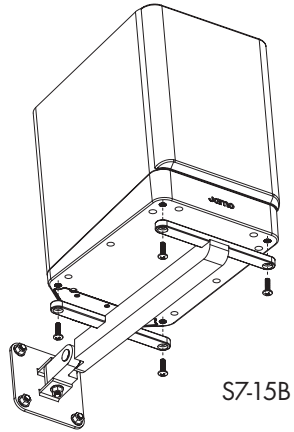

CUIDADO Y LIMPIEZA

Lo único que puede ser necesario hacerles a los altavoces es quitarles el polvo de vez en cuando. No les aplique nunca ni detergentes fuertes ni limpiadores abrasivos o a base de disolvente.

El accesorio de cepillo de su aspiradora sirve para quitarles el polvo a las rejillas de altavoz.

Jamo STUDIO7 SERIES

ERSTE SCHRITTE

Manche Jamo Lautsprecher verfügen über FüÙe oder anderes Zubehöör, das vor der Benutzung installiert werden muss.

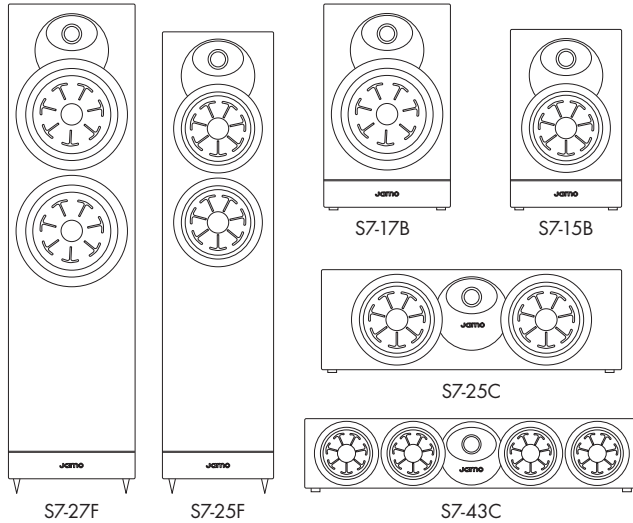

STANDLAUTSPRECHER (METALL-SPIKES)

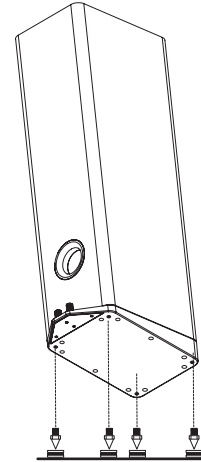

ANDERE LAUTSPRECHER (GUMMIFÜÙE)

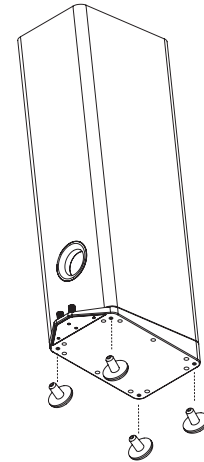

AUFSTELLUNG IM RAUM

Linker und rechter Hauptlautsprecher - Zur optimalen Leistung empfiehlt Jamo, dass Sie die Lautsprecher 1,80 m bis 4,60 m voneinander entfernt und mindestens 60 cm von den Rück- und Seitenwänden aufstellen. Um ein besseres Stereoklangbild zu erhalten, sollten Sie sie eventuell etwas nach innen ausrichten. Der Abstand der Hörposition zu den Lautsprechern sollte etwa 1 bis 1,5 mal so groß wie der Abstand der Lautsprecher zueinander sein. Abbildungen 1 und 3 zeigen Ihnen die korrekten Anschlüsse und Platzierungen.

Center-Lautsprecher - Die Center-Lautsprecher dienen dazu, die Dialoge und den Hauptton so wiederzugeben, dass sie aus dem Videobildschirm zu kommen scheinen. Diese Lautsprecher sollten daher so nah wie möglich am Bildschirm platziert werden, am besten direkt unterhalb des Bildschirms. Die Abbildungen 1, 2 und 3 zeigen Ihnen die korrekten Anschlüsse und Platzierungen.

Surround-Lautsprecher - Die Surround-Lautsprecher müssen sich neben der Hörposition befinden. Eine andere Möglichkeit ist, die Lautsprecher hinter der Hörposition zu platzieren. Die Positionierung der Surround-Lautsprecher hängt von den Eigenschaften Ihres Raumes ab. Sie sollen ein Gefühl von Raum und Atmosphäre erzeugen. Beziehen Sie sich für den Anschluss und die Positionierung auf die Abbildungen 1, 3 und 4.

ANSCHLÜSSE

Konventioneller Anschluss - Verwenden Sie 16AWG (1,3 mm²) Lautsprecherkabel (oder dicker) und verbinden Sie den ROTEN, positiven (+) Anschluss des LINKEN Lautsprechers mit dem ROTEN, positiven (+) Anschluss des LINKEN Kanals Ihres Verstärkers. Verbinden Sie den SCHWARZEN, negativen (-) Anschluss des LINKEN Lautsprechers mit dem SCHWARZEN, negativen (-) Anschluss des LINKEN Kanals Ihres Verstärkers. Wiederholen Sie dieses Verfahren für den Anschluss aller verbleibenden Lautsprecher an die entsprechenden Verstärkerkanäle. Siehe Abbildung 3. Vergewissern Sie sich, dass kein blanker Draht von einem der Anschlüsse andere Klemmen berührt, da dies einen Kurzschluss hervorrufen und Ihre Geräte beschädigen könnte.

Verstärkeranforderungen - Jamo Studio7-Lautsprecher sind wirkungsgradstark und als 4-Ohm-Last spezifiziert. Um eine optimale Leistung zu erzielen, stellen Sie bitte sicher, dass Ihr Verstärker für den Betrieb an 4 Ohm ausgelegt ist. Ihre Jamo -Lautsprecher sind in der Lage, eine sehr hohe akustische Leistung bei geringen Verzerrungswerten zu erbringen. Seien Sie daher bitte vorsichtig, wenn Sie über einen längeren Zeitraum mit hohen Pegeln hören, da dies zu Gehörschäden führen kann.

ABBILDUNG 1
LAUTSPRECHERPLATZIERUNG IM HÖRBEREICH



ABBILDUNG 3
STANDARDANSCHLÜSSE



ABBILDUNG 2
CENTER-KANAL

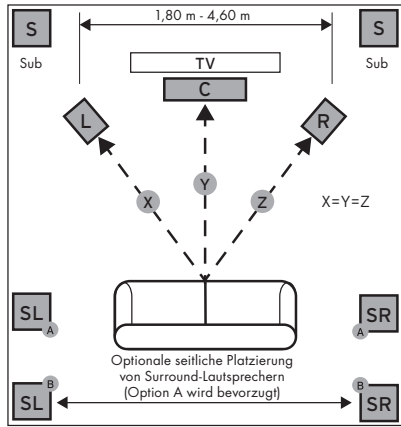

ABBILDUNG 4
WANDBEFESTIGUNG VON SURROUND-LAUTSPRECHERN FÜR S7-15B

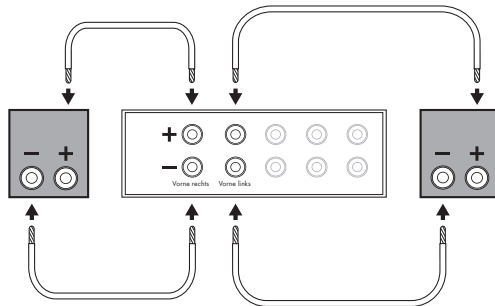

(Optional / Halterungen sind nicht im Lieferumfang enthalten)

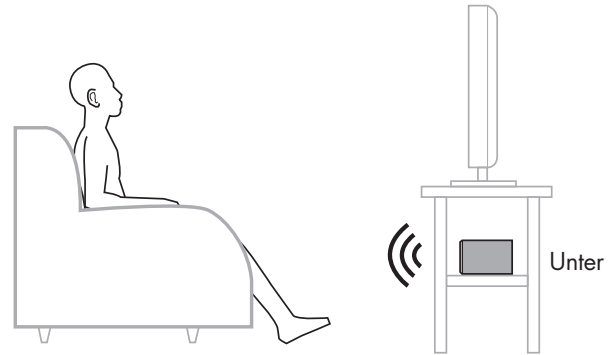
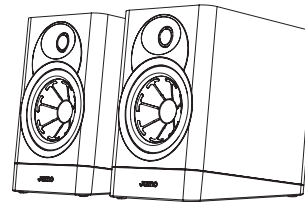
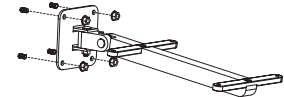

VORSICHT!
Verwenden Sie das Befestigungsloch nicht für eine Wand- oder Deckenmontage!

WANDBEFESTIGUNG FÜR S7-15B

(OPTIONAL / HALTERUNGEN SIND NICHT IM LIEFERUMFANG ENTHALTEN)

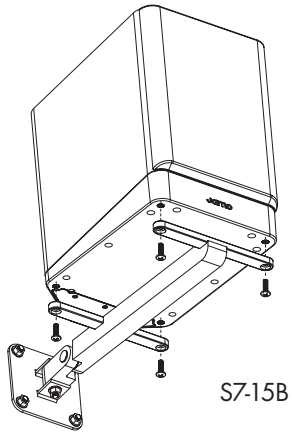

PFLEGE UND REINIGUNG

Die einzig nötige Pflege Ihrer Lautsprecher besteht darin, sie gelegentlich abzustauben. Verwenden Sie nie Scheuermittel, Lösungsmittel enthaltende oder aggressive Reinigungsmittel. Sie können die Lautsprechergrills mit dem Bürstenaufsatz eines Staubsaugers reinigen.

Jamo STUDIO7 SERIES

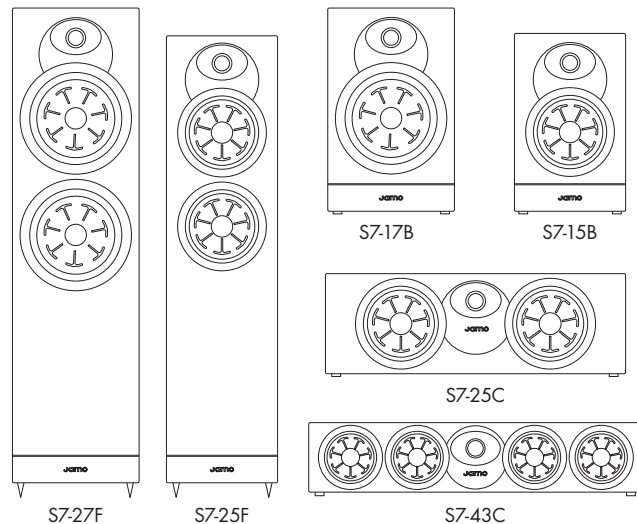

OPERAZIONI PRELIMINARI

Alcuni altoparlanti Jamo sono dotati di piedini e altri accessori che potrebbe essere necessario installare prima dell'uso.

ALTOPARLANTI DA PAVIMENTO (PUNTE DI METALLO)

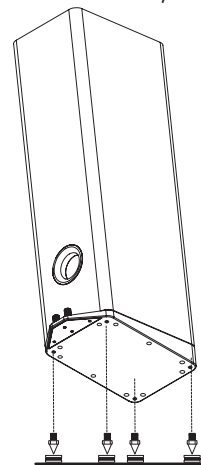

ALTRI ALTOPARLANTI (PIEDINI IN GOMMA)

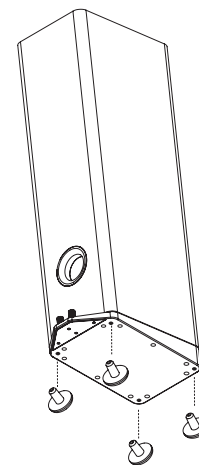

COLLOCAZIONE NELLA SALA

Altoparlanti sinistro e destro principale - Per ottenere prestazioni ottimali, Jamo suggerisce di collocare gli altoparlanti a una distanza compresa tra 1,80 e 4,60 metri l'uno dall'altro e ad almeno 60 centimetri di distanza dalle pareti posteriore e laterali. Inoltre gli altoparlanti possono essere angolati leggermente verso l'interno per ottenere un'immagine stereo migliore. La distanza di ascolto deve essere pari a circa 1 - 1,5 volte la distanza di separazione tra gli altoparlanti. Vedere le figure 1 e 3 per le connessioni e la collocazione.

Altoparlanti centrali - Sono progettati per riprodurre il suono in modo che i dialoghi e gli altri suoni principali sembrano provenire dallo schermo. Pertanto, dovrebbero essere posizionati il più vicino possibile allo schermo stesso, se possibile direttamente sotto di esso. Vedere le figure 1, 2 e 3 per i collegamenti e il posizionamento.

Altoparlanti surround - Gli altoparlanti surround devono essere direttamente adiacente alla posizione di ascolto. Un'altra scelta potrebbe essere quella di posizionarli dietro la posizione di ascolto. La collocazione finale dei altoparlanti surround dipende dalle caratteristiche della stanza, poiché sono progettati per ricreare la sensazione di spazio. Vedere le figure 1, 3 e 4 per i collegamenti e il posizionamento.

COLLEGAMENTO

Collegamento tipico - Usando cavi di potenza di sezione uguale o maggiore di 1,3 mm² (16 AWG), collegare il terminale "positivo" (+) ROSSO e il terminale "negativo" (-) NERO dell'altoparlante SINISTRO rispettivamente ai terminali "positivo" (+) ROSSO e "negativo" (-) NERO del canale SINISTRO dell'amplificatore. Procedere in questo modo per collegare tutti gli altri altoparlanti ai corrispondenti canali dell'amplificatore. Vedere la figura 3. Accertarsi che nessun conduttore nudo di una connessione tocchi qualunque altro terminale, altrimenti si potrebbe causare un cortocircuito e danni all'impianto.

Requisiti sull'amplificatore - Gli altoparlanti Jamo Studio7 sono efficienti e sono classificati per un carico di 4 ohm. Per ottenere prestazioni ottimali, accertarsi che il proprio amplificatore sia dimensionato per l'uso con un carico di 4 ohm. Gli altoparlanti Jamo sono in grado di produrre un'uscita acustica molto elevata a bassi livelli di distorsione, pertanto si consiglia di prestare attenzione quando si ascoltano livelli elevati per lunghi periodi, poiché ciò potrebbe causare danni all'udito.

FIGURA 1
COLLOCAZIONE DEGLI ALTOPARLANTI NELL'AREA DI ASCOLTO



FIGURA 3
CONNESSIONI STANDARD



FIGURA 2
CANALE CENTRALE

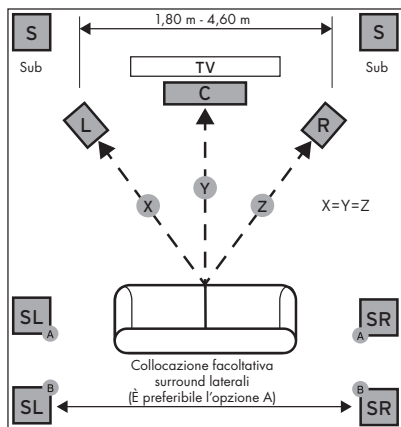

FIGURA 4
FISSAGGIO A PARETE DEGLI ALTOPARLANTI SURROUND S7-15B

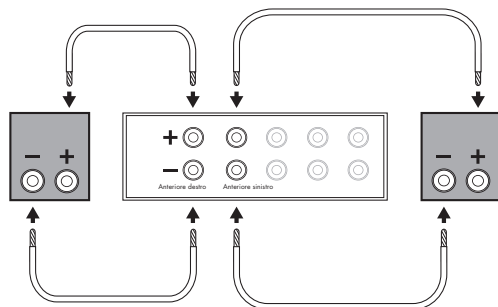

(Le staffe opzionali non sono fornite)

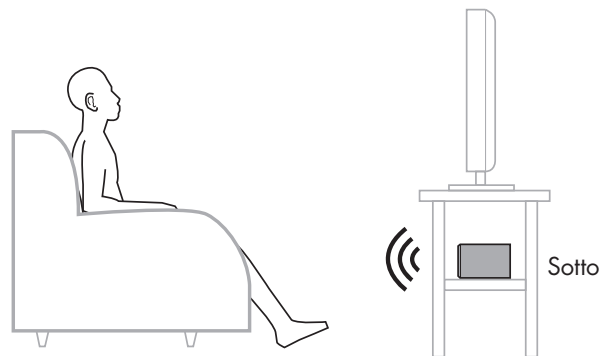
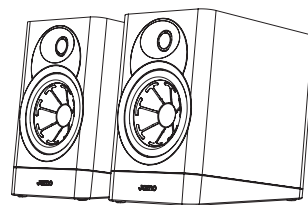
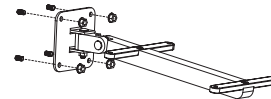

ATTENZIONE!
Non utilizzare i viti per fissare l'altoparlanti al soffitto o alla parete!

INSTALLAZIONE A PARETE PER S7-15B

(LE STAFFE OPZIONALI NON SONO FORNITE)

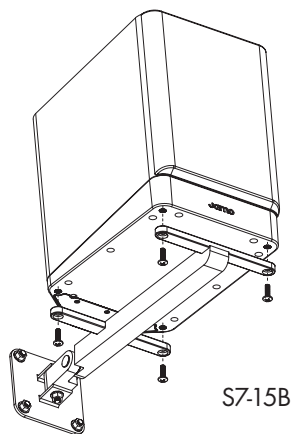

S7-15B

CURA E PULIZIA

Per pulire gli altoparlanti basta spolverarli di tanto in tanto. Non applicare mai abrasivi o detergenti forti o a base di solvente. Le griglie possono essere pulite con l'accessorio a spazzola di un aspirapolvere.

Jamo STUDIO7 SERIES

ANTES DE COMEÇAR

Algumas caixas acústicas Jamo têm bases e outros acessórios que podem necessitar de instalação antes de serem usadas.

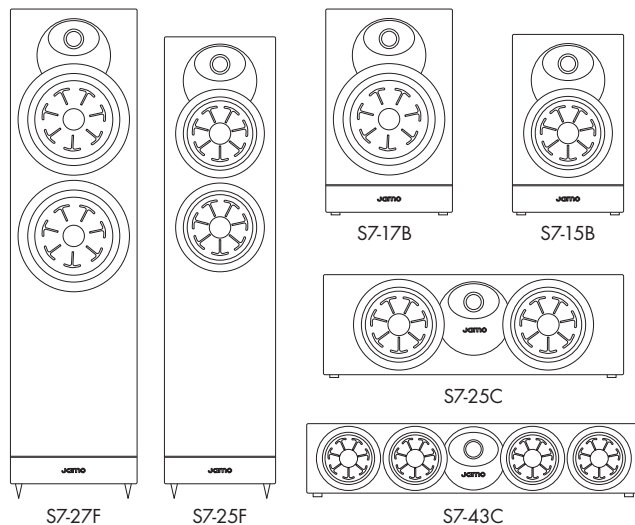

ALTO-FALANTES DE PISO (SUPPORTES DE METAL)

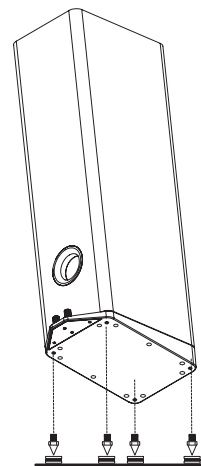

OUTROS ALTO-FALANTES (PÉS DE BORRACHA)

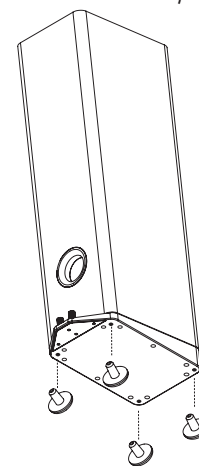

POSICIONAMENTO NO AMBIENTE

Alto-falantes principais esquerdo e direito - Para o máximo desempenho, a Jamo sugere o posicionamento dos alto-falantes 1,8 a 4,6 metros de distância e pelo menos 60 cm das paredes laterais e traseiras. Podem também ser posicionados num ângulo, com os planos da frente ligeiramente virados uns para os outros para uma melhor fidelidade em reprodução estereofónica. A posição de escuta deve ser cerca de um a uma vez e meia a distância entre os alto-falantes. Ver figuras 1 e 3 ilustram aspectos de ligação e posicionamento das unidades.

Alto-falantes centrais - Os alto-falantes centrais são concebidos para reproduzir o diálogo e os sons primários de modo a que apareçam a partir do ecrã. Devem, portanto, ser posicionados o mais próximo possível do ecrã, e de preferência directamente abaixo do ecrã. Ver figuras 1, 2 e 3, que ilustram o posicionamento dos alto-falantes e das ligações.

Alto-falantes Surround - Os alto-falantes Surround devem ser adjacentes à posição de audição. Outra opção é instalá-los atrás da posição de escuta. O posicionamento dos alto-falantes circundantes depende das características da sua sala. São concebidos para recriar a sensação de espaço e ambiente. Ver figuras 1, 3 e 4 para ligação e posicionamento.

CONEXÃO

Ligação convencional - Usando cabos com um diâmetro de pelo menos 1,3 mm² (16 AWG), ligue o terminal VERMELHO “positivo” (+) do alto-falantes esquerdo ao terminal VERMELHO “positivo” (+) do canal esquerdo do seu amplificador. Ligue o terminal PRETO “negativo” (-) do alto-falantes ESQUERDO ao terminal PRETO “negativo” (-) do canal ESQUERDO do seu amplificador. Repetir este procedimento para ligar todos os oradores restantes. Consultar a figura 3. Certifique-se de que nenhum dos fios nus utilizados para as ligações toca em qualquer outro terminal, uma vez que isto pode causar um curto-circuito e danificar o seu equipamento.

Requisitos para o amplificador - Os alto-falantes Jamo Studio 7 são eficientes e classificados como uma carga de 4 ohms. Para um ótimo desempenho, certifique-se de que o seu amplificador está classificado para utilização em 4 ohms. Os seus alto-falantes Jamo são capazes de uma saída acústica muito elevada a baixos níveis de distorção, por isso, por favor, tenha cuidado ao ouvir a níveis elevados durante longos períodos, pois isto poderia levar a danos auditivos.

FIGURA 1
 POSICIONAMENTO DOS ALTO-FALANTES NA ÁREA DE AUDIÇÃO



FIGURA 3
 LIGAÇÕES STANDARD



FIGURA 2
 ALTIFALANTE CENTRAL

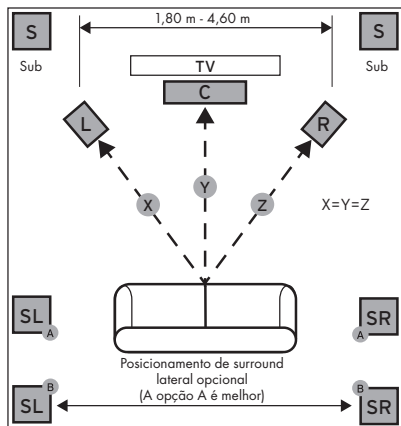

FIGURA 4
 MONTAGEM NA PAREDE DO ALTO-FALANTE SURROUND S7-15B

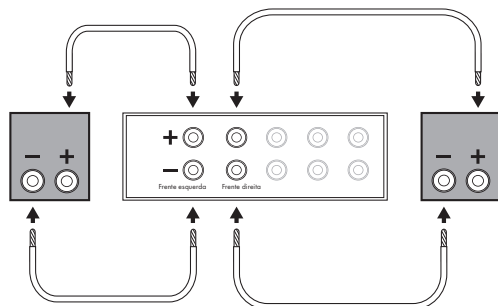

(Opcional / As fixações não estão incluídas na caixa)

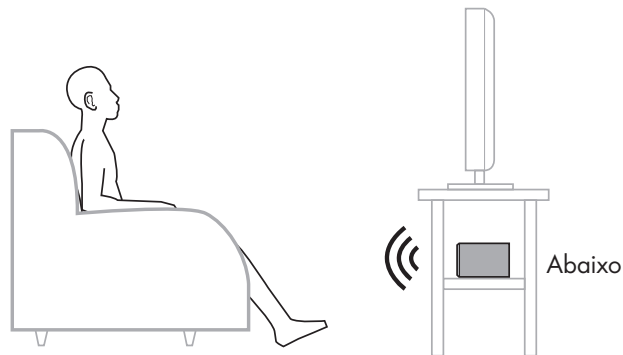
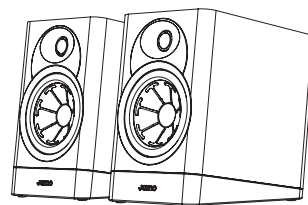
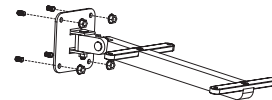

CUIDADO!
 Não utilizar o buraco da fechadura para instalação em paredes ou tectos!

MONTAGEM NA PAREDE PARA S7-15B

(OPCIONAL / AS FIXAÇÕES NÃO ESTÃO INCLUÍDAS NA CAIXA)

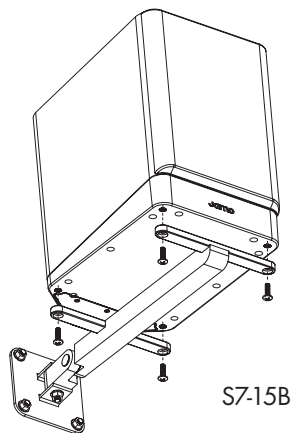

S7-15B

CUIDADO E LIMPEZA

O cuidado das caixas acústicas só requer a remoção periódica do pó acumulado nas superfícies. Nunca use qualquer tipo de produto de limpeza abrasivo ou à base de solventes, nem qualquer detergente forte. As grades podem ser limpas com a escova de um aspirador de pó.

Jamo STUDIO7 系列扬声器

开始使用之前

有些JAMO音箱配有脚垫和其它附件，
需要在使用前进行安装

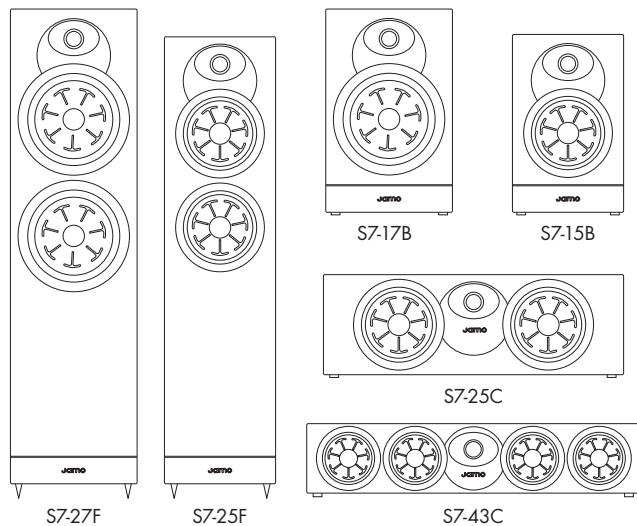

落地式扬声器 (金属尖端)

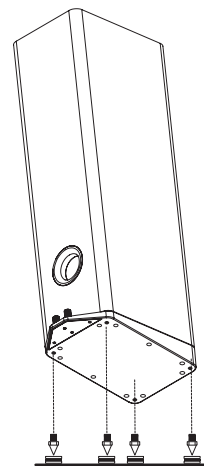

其他扬声器 (橡胶脚)

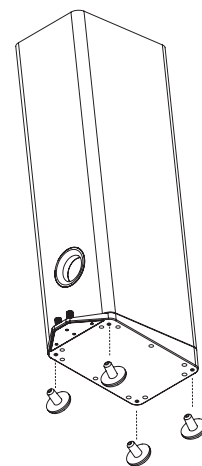

室内音箱的布放

左边和右边的主通道扬声器 – 为了获得最佳性能。Jamo建议将您的扬声器相隔6至15英尺（1.8至4.6米），并距离墙壁至少60厘米。它们也可以稍微向内倾斜以获得更好的立体声成像。聆听的位置应约为扬声器之间距离的1至1.5倍。聆听位置应是扬声器之间距离的1至1.5倍。请参考图1和图3 连接和放置。

中置扬声器：根据设计，中置扬声器旨在重现对话和背景声音，让人觉得这些声音是来自视频屏幕。因此，中置扬声器应尽可能地靠近屏幕，最好是直接放在屏幕下方。请参考图1、图2和图3，了解扬声器的连接和放置。

环绕声扬声器 – Jamo

环绕声扬声器应直接与聆听位置相邻。另一个选择是将它们放在聆听位置的后面。环绕声扬声器的位置取决于你房间的特点。它们的设计是为了重新创造空间和氛围的感觉。关于连接和定位，请参考图1、3和4。

电气连接

传统连接 – 使用16–12号线的扬声器电线，将左边扬声器的红色“正”（+）端与红色“正”（+）端连接起来。左侧扬声器的红色“正”（+）端与放大器左侧通道的红色“正”（+）端相连。扬声器的红色“正”（+）端子连接到放大器左声道的红色“正”（+）端子。将左扬声器的黑色“负极”连接到放大器左声道的红色“正极”（+）终端。（-）端子连接到您的放大器左声道的黑色“负”（-）端子。您的放大器左声道的黑色“负”（-）端子。

重复上述程序，将所有剩余的扬声器连接到适当的放大器通道上。请参考图3。确保任何连接处的裸线都不接触任何其他终端，因为这可能导致短路并损坏您的设备。

放大器要求 – Jamo Studio7扬声器是高输出的，有一个4欧姆的额定负载。为了获得最佳性能，确保你的放大器是为使用4欧姆负载而设计的。您的Jamo扬声器能够实现高音量的声音和低水平的失真。长时间在高音量下收听时要小心，因为这可能导致听力损伤。

图1
在聆听区域放置扬声器



图3
标准连接



图2
中间声道

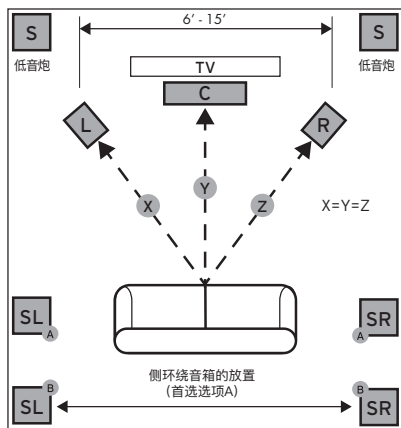

图4
S7-15B入墙式环绕扬声器。

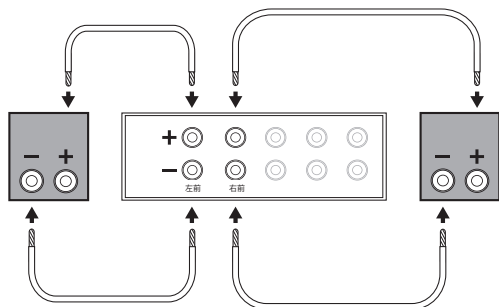

(可选--支架 不包括在盒子里)

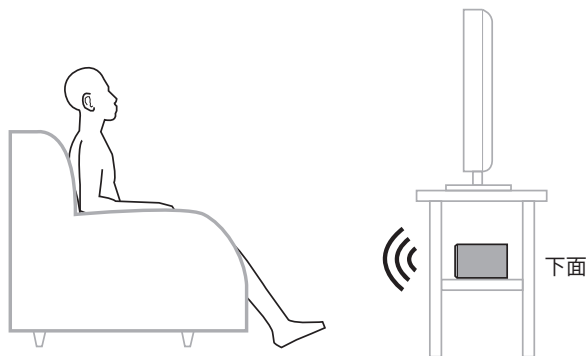
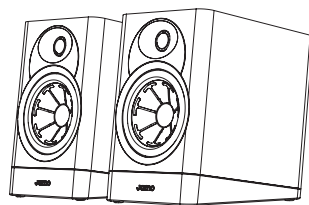
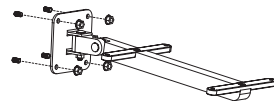

注意!
请不要使用天花板或墙壁的安装孔!

壁挂式

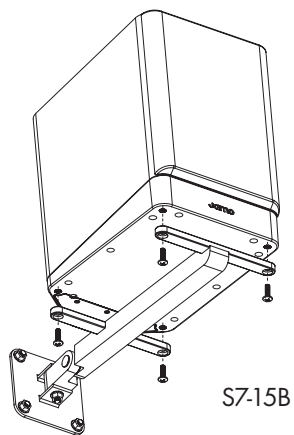

S7-15B

保养和清洁

您需要做的只是偶尔掸去音箱的灰尘。不要使用任何摩擦性或溶解性清洁剂以及任何粗糙的去污剂。可以使用吸尘器配备的刷子来清洁面网。

Jamo®

EST. 1968

Jamo®

EST. 1968

3502 WOODVIEW TRACE, INDIANAPOLIS, IN, USA

www.jamo.com

Jamo Corporate Office: 3502 Woodview Trace, Indianapolis, IN, USA 46268-1104. A wholly-owned subsidiary of VOXX International Corporation, jamo.com 1-800-554-7724 © 2022 Klipsch Group, Inc. All rights reserved. Jamo is a registered trademark of Klipsch Group, Inc. Engineered by Klipsch Group, Inc., USA. Made in China.