

DH-IPC-HDBW3441R-Z(A)S-S2

4MP IR Vari-focal Dome WizSense Network Camera



WizSense

Launched by Dahua Technology, WizSense is a series of AI products and solutions that adopt independent AI chip and deep learning algorithm. It focuses on human and vehicle with high accuracy, enabling users to fast act on defined targets. Based on Dahua's advanced technologies, WizSense provides intelligent, simple and inclusive products and solutions.

Series Overview

Dahua WizSense 3 Series Network Camera greatly saves on bandwidth and storage space through its AI Coding technology. Driven by its advanced deep learning algorithms, the camera supports intelligent functions such as perimeter protection, smart motion detection (SMD), Quick Pick, and AI SSA (AI Scene Self-adaptation), making it easy and convenient to use. Starlight technology and its large aperture lens also allow the camera to produce clear, vivid images even in poor lighting conditions.

Functions

SMD 4.0

Dahua Smart Motion Detection technology works with intelligent algorithms to classify targets that trigger motion detection alarms. It filters out objects that are not targets, such as small and large animals, to avoid triggering false alarms. With an AI NVR, Quick Pick technology becomes available, allowing you to easily search for and pick out human and vehicle targets from SMD event videos, prioritizing the highest matches.

AI SSA

Dahua AI Scene Self-adaptation (AI SSA) adopts deep learning algorithms to detect environmental conditions, such as rain, fog, backlight, low light and flicker, to adjust the parameters of the image to suit the conditions, ensuring that clear images are always produced.

Smart H.265+ & Smart H.264+

With advanced scene-adaptive rate control algorithm, Dahua smart encoding technology realizes the higher encoding efficiency than H.265 and H.264, provides high-quality video, and reduces the cost of storage and bandwidth.

- 4-MP 1/2.9" CMOS image sensor, excellent low luminance performance and high definition of images.
- Outputs max. 4 MP (2688 × 1520) @25/30 fps.
- H.265 codec, high compression rate, ultra-low bit rate.
- Built-in IR LED, max. IR distance: 40 m.
- ROI, SMART H.264 +/H.265+, AI H.264/H.265, flexible coding, applicable to various bandwidth and storage environments.
- Rotation mode, WDR, 3D NR, HLC, BLC, digital watermarking, applicable to various monitoring scenes.
- Intelligent detection: Intrusion, tripwire (support the classification and accurate detection of vehicle and human).
- Abnormality detection: Motion detection, privacy masking, scene changing, audio detection, no SD card, SD card full, SD card error, network disconnection, IP conflict, illegal access, and voltage detection.
- Alarm: 1 in, 1 out (Only - ZAS supports); audio: 1 in, 1 out (Only - ZAS supports); max. 256 G Micro SD card; built-in Mic.
- 12 VDC/PoE power supply facilitates installation.
- IP67, IK10 protection.
- SMD 4.0, AI SSA.

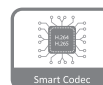

Perimeter Protection

With deep learning algorithm, Dahua Perimeter Protection technology can recognize human and vehicle accurately. In restricted area (such as pedestrian area and vehicle area), the false alarms of intelligent detection based on target type (such as tripwire, intrusion) are largely reduced.

Protection (IP67, IK10, Wide Voltage)

IP67: The camera passes a series of strict test on dust and soak. It has dust-proof function, and the enclosure can work normally after soaking in 1 m deep water for 30 minutes.

IK10: The enclosure can stand the punch more than 5 times from a 5 kg hammer falling from a height of 40 cm (Impact energy is 20J).

Wide voltage: The camera allows $\pm 30\%$ (for some power supplies) input voltage tolerance (wide voltage range), and it is widely applied to outdoor environment with instable voltage.

Cyber Security

Dahua network cameras employ a series of security technologies, including security authentication and authorization, access control protocols, trusted protection, encrypted transmission and encrypted storage. These technologies improve the camera's defense against external cyber threats and prevent malicious programs from comprising the device.

<https://www.conecticplus.com/>

Technical Specification

Camera

Image Sensor	1/2.9" CMOS
Max. Resolution	2688 (H) × 1520 (V)
ROM	128 MB
RAM	512 MB
Scanning System	Progressive
Electronic Shutter Speed	Auto/Manual 1/3 s–1/100,000 s
Min. Illumination	0.005 lux@F1.5 (Color, 30 IRE) 0.0005 lux@F1.5 (B/W, 30 IRE) 0 lux (Illuminator on)
S/N Ratio	>56 dB
Illumination Distance	Up to 40 m (131.23 ft)
Illuminator On/Off Control	Auto/Manual
Illuminator Number	3 (IR LED)
Angle Adjustment	Pan: 0°–355°; Tilt: 0°–80°; Rotation: 0°–355°

Lens

Lens Type	Motorized vari-focal				
Lens Mount	φ14				
Focal Length	2.7 mm–13.5 mm				
Max. Aperture	F1.5				
Field of View	H: 104°–29° V: 54°–16° D: 125°–33°				
Iris Control	Fixed				
Close Focus Distance	0.8 m (2.62 ft)				
DORI Distance	Lens	Detect	Observe	Recognize	Identify
	W	64.0 m (210.0 ft)	25.6 m (83.99 ft)	12.8 m (42.00 ft)	6.4 m (21.00 ft)
	T	210.0 m (688.98 ft)	84.0 m (275.60 ft)	42.0 m (137.80 ft)	21.0 m (68.90 ft)

Intelligence

IVS (Perimeter Protection)	Tripwire, intrusion (support the classification and accurate detection of vehicle and human);
AI SSA	Yes
Quick Pick	With AI NVR, quickly pick up the human/vehicle targets that users are interested in from SMD events
Smart Search	Work together with Smart NVR to perform refine intelligent search, event extraction and merging to event videos

Video

Video Compression	H.265; H.264; H.264H; H.264B; MJPEG (only supported by the sub stream)
Smart Codec	Smart H.265+ Smart H.264+
AI Coding	AI H.265 AI H.264

Video Frame Rate	Main stream: 2688 × 1520 @ (1–25/30) fps Sub stream 1: 704 × 576 @ (1–25 fps)/704 × 480 @ (1–30 fps) Sub stream 2: 1920 × 1080 @ (1–25/30 fps) *The values above are the max. frame rates of each stream; for multiple streams, the values will be subjected to the total encoding capacity
Stream Capability	3 streams
Resolution	4M (2688 × 1520); 3.6M (2560 × 1440); 3M (2048 × 1536); 3M (2304 × 1296); 1080p (1920 × 1080); 1.3M(1280 × 960); 720p (1280 × 720); D1 (704 × 576/704 × 480); CIF (352 × 288/352 × 240); VGA (640 × 480)
Bit Rate Control	CBR/VBR
Video Bit Rate	H.264: 3 kbps–8192 kbps H.265: 3 kbps–8192 kbps
Day/Night	Auto (ICR)/Color/B/W
BLC	Yes
HLC	Yes
WDR	120 dB
Scene Self-adaptation (SSA)	Yes
White Balance	Auto; natural; street lamp; outdoor; manual; regional custom
Gain Control	Auto
Noise Reduction	3D NR
Motion Detection	OFF/ON (4 areas, rectangular)
Image Stabilization	Electronic Image Stabilization (EIS)
Region of Interest (RoI)	Yes (4 areas)
Defog	Yes
AFSA	Yes
Image Rotation	0°/90°/180°/270° (support 90°/270° with 2688 × 1520 resolution and lower)
Mirror	Yes
Privacy Masking	4 areas
Audio	
Built-in MIC	Yes, built-in Mic
Audio Compression	G.711a; G.711Mu; PCM; G.726; G.723
Alarm	
Alarm Event	-ZAS: No SD card; SD card full; SD card error; service life warning (only supported by Dahua card); network disconnection; IP conflict; illegal access; motion detection; video tampering; intrusion; tripwire; scene changing; audio detection; voltage detection; defocus detection; external alarm; SMD; safety exception
	-ZS: No SD card; SD card full; SD card error; service life warning (only supported by Dahua card); network disconnection; IP conflict; illegal access; motion detection; video tampering; intrusion; tripwire; scene changing; audio detection; voltage detection; defocus detection; SMD; safety exception

<https://www.conecticplus.com/>

Network	
Network Port	RJ-45 (10/100 Base-T)
SDK and API	Yes
Network Protocol	IPv4; IPv6; HTTP; TCP; UDP; ARP; RTP; RTSP; RTCP; RTMP; SMTP; FTP; SFTP; DHCP; DNS; DDNS; QoS; UPnP; NTP; Multicast; ICMP; IGMP; NFS; SAMBA; PPPoE; SNMP; P2P
Cyber Security	Video encryption; Firmware encryption; Configuration encryption; Digest; WSSE; Account lockout; Security logs; IP/MAC filtering; Generation and importing of X.509 certification; syslog; HTTPS; 802.1x; Trusted boot; Trusted execution; Trusted upgrade
Interoperability	ONVIF (Profile S/Profile G/Profile T); CGI
User/Host	20 (Total bandwidth: 64 M)
Storage	FTP; SFTP; Micro SD card (support max. 256 G); NAS
Browser	IE: IE11 Chrome Firefox
Management Software	SmartPSS Lite; DSS; DMSS
Mobile Client	iOS; Android

Certification	
Certifications	CE-LVD: EN62368-1; CE-EMC: Electromagnetic Compatibility Directive 2014/30/EU; FCC: 47 CFR FCC Part 15, Subpart B; UL/CUL: UL62368-1 & CAN/CSA C22.2 No. 62368-1-14

Port	
Audio Input	1 channel (RCA port) (Only- ZAS supports)
Audio Output	1 channel (RCA port) (Only- ZAS supports)
Alarm Input	1 channel in: wet contact, 5 mA 3 V–5 VDC (Only- ZAS supports)
Alarm Output	1 channel out: wet contact, 300 mA 12 VDC (Only- ZAS supports)

Power	
Power Supply	12 VDC/PoE (802.3af)
Power Consumption	Basic: 2.8 W (12 VDC); 3.6 W (PoE) Max. (WDR + IR intensity + Intelligence): 7.9 W (12 VDC); 9.2 W (PoE)

Environment	
Operating Temperature	-30 °C to +60 °C (-22 °F to 140 °F) / Less than 95% RH
Storage Temperature	-40 °C to +60 °C (-40 °F to 140 °F)
Protection	IP67; IK10

Structure	
Casing	Metal
Product Dimensions	94 mm × Φ122 mm (3.7" × Φ4.8")
Net Weight	713 g (1.57 lb)
Gross Weight	986 g (2.17 lb)

Ordering Information		
Type	Model	Description
4MP Camera	DH-IPC-HDBW3441R-ZAS-S2	4MP IR Vari-focal Dome WizSense Network Camera
	DH-IPC-HDBW3441R-ZS-S2	4MP IR Vari-focal Dome WizSense Network Camera
Accessories (Optional)	PFA137	Junction Box Bracket
	PFA109	Mount Adapter
	PFB220C	Ceiling Mount Bracket
	PFB206W	Wall Mount
	PFA152-E	Pole Mount
	PFM321D	12 VDC 1 A Power Adapter
	PFM900-E	Integrated Mount Tester
TF-P100	TLC SD Card	

Accessories

Optional:



PFA137
Junction
Box Bracket



PFA109
Mount
Adapter



PFB220C
Ceiling Mount
Bracket



PFM321D
12 VDC 1 A
Power Adapter



PFB206W
Wall
Mount



PFA152-E
Pole
Mount



PFM900-E
Integrated
Mount Tester



TF-P100
TLC SD
Card

<https://www.conecticplus.com/>

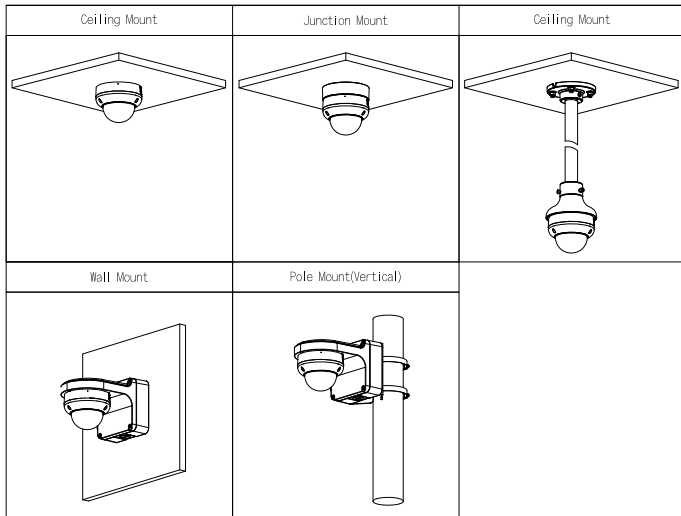

Dimensions (mm[inch])

