

# DH-SDT6C425-4P-GB-APV-0280

4MP 25× Smart Dual Light Network Panoramic PTZ Camera



**Wiz Sense**

Launched by Dahua Technology, WizSense is a series of AI products and solutions that adopt independent AI chip and deep learning algorithm. It focuses on human and vehicle with high accuracy, enabling users to fast act on defined targets. Based on Dahua's advanced technologies, WizSense provides intelligent, simple and inclusive products and solutions.

## System Overview

The multi-sensor series pushes the bar on PTZ cameras with its enhanced monitoring capabilities captured in its unique lens design. Fitted with an extra lens, it quickly tracks targets while keeping an eye on the monitored area. They also harness the strength of their embedded AI intelligent chip to perform a wide variety of intelligent functions, making them ideal for use in many scenarios.

- 1/2.8" 4Megapixel STARVIS™ CMOS.
- 25× optical zoom.
- Starlight technology.
- Max. 25/30 fps@2560 × 1440..
- IR distance up to 200 m.
- Auto-tracking.
- Perimeter protection.
- Face detection.
- IP66.
- Sound and light alarm.
- 180° panoramic splicing.



## Functions

### Face Detection

Supports 6 attributes and 8 expressions. It also supports face cutout settings: Face, and single inch photo. Three snapshot methods are also featured: Real-time snapshot, priority snapshot, and quality priority.

### Wide Dynamic Range

The camera produces vivid images, even in high-contrast lighting conditions, by using industry-leading wide dynamic range (WDR) technology. For scenes that quickly alternate between bright and low lighting, WDR adjusts to fully capture both the bright and dark areas of a scene, producing superior quality videos.

### Perimeter Protection

Automatically filters out false alarms caused by animals, rustling leaves, bright lights, and more, and uses secondary recognition during target detection to improve alarm accuracy.

**Technical Specification**

**Camera**

Image Sensor	Panorama: 1/2.8" CMOS Detail: 1/2.8" CMOS
Pixel	Panorama: 4 MP Detail: 4 MP
Max. Resolution	Panorama: 3840 (H) × 1080 (V) Detail: 2560 (H) × 1440 (V)
ROM	Panorama: 4 GB Detail: 4GB
RAM	Panorama: 1 GB Detail: 1 GB
Electronic Shutter Speed	Panorama: 1/1 s–1/10,000s Detail: 1/1s–1/30,000s
Scanning System	Progressive
Min. Illumination	Panorama: Color: 0.001 lux@F1.0 B/W: 0.0001 lux@F1.0 Detail: Color: 0.005 lux@F1.6 (1/25 s, 30 IRE, gain 100) B/W: 0.0005 lux@F1.6 (1/25 s, 30 IRE, gain 100) 0 Lux (IR on)
Illumination Distance	Panorama: 30 m (98.43 ft) (White light) Detail: 200 m (656.17 ft) (IR)
Illuminator On/Off Control	Zoom Prio; Manual; Smart IR; Off
Illuminator Number	Panorama: 4 (White light) Detail: 4 (IR), 2 (White light)

**Lens**

Focal Length	Panorama: 2.8 mm Detail: 5 mm–125 mm			
Max. Aperture	Panorama: F1.0 Detail: F1.6–3.6			
Field of View	Panorama: H: 180° ± 5°; V: 51° Detail: H: 53.4°–3.4°; V: 30.4°–1.95°; D: 59.3°–3.9°			
Optical Zoom	Panorama: NA Detail: 25×			
Focus Control	Panorama: NA Detail: Auto; semi-auto; manual			
Close Focus Distance	Panorama: 0.3 m (0.98 ft) Detail: 1 m–9 m (3.28 ft–29.53 ft)			
Iris Control	Panorama: Fixed Detail: Auto; manual			
DORI Distance	Detect	Observe	Recognize	Identify
	Panorama: 38.6 m (126.64 ft) Detail: 2500 m (8202.10 ft)	Panorama: 15.3 m (50.20 ft) Detail: 987.5 m (3239.83 ft)	Panorama: 7.7 m (25.26 ft) Detail: 500 m (1640.42 ft)	Panorama: 3.9 m (12.80 ft) Detail: 250 m (820.21 ft)

**PTZ**

Pan/Tilt Range	Detail: H: 0°–360° endless V: –20°–+90°
Manual Control Speed	Detail: Pan: 0.1°/s–160°/s Tilt: 0.1°/s–120°/s
Preset Speed	Detail: Pan: 240°/s; Tilt: 200°/s
Preset	300
Tour	8 (up to 32 presets per tour)
Pattern	5
Scan	5
Power-off Memory	Yes
Idle Motion	Pattern; Preset; Scan; Tour
PTZ Protocol	DH-SD Pelco-P/D(Auto recognition)

**Intelligence**

IVS (Perimeter Protection)	Tripwire; intrusion; crossing fence detection; loitering detection; abandoned/missing object; fast moving; parking detection; people gathering; vehicle/human alarm classification; linkage tracking
Face Detection	Supports face detection, optimization, tracking, capturing pictures, uploading high-quality face snapshots, and face enhancement; Extracts 6 attributes and 8 expressions; Supports face cutout: Face, one-inch photo. Capturing strategies include real-time capturing, optimization, and quality first
Auto Tracking	Yes

**Active Deterrence**

Light Warning	Supports white light warning; the flashing time can be configured as: 5 to 30 seconds, and the frequency can be configured as high/medium/low
Sound Warning	A total of 11 audio alarm contents, and supports importing custom audio. The sound can be configured at three levels: high/medium/low, and the duration time can be configured as 5 to 30 seconds. 110 dB.

**Video**

Video Compression	H.264H;H.264B;Smart H.265+;H.265;MJPEG(Sub Stream);Smart H.264+;H.264M
Streaming Capability	3 streams
Resolution	Panorama: 3840 × 1080; 960 × 268; D1 (704 × 576/704 × 480); VGA (640 × 480); CIF (352 × 288/352 × 240); Details: 2560 × 1440 (2560 × 1440); 3M (2048 × 1536); 3M (2304 × 1296); 1080p (1920 × 1080); 1.3M (1280 × 960); 720p (1280 × 720); D1 (704 × 576/704 × 480); VGA (640 × 480); CIF(352 × 288/352 × 240)

<https://www.conecticplus.com/>

<b>Video Frame Rate</b>	<p>Panorama: 50 Hz Main stream (3840 × 1080@25 fps), Sub stream 1 (960 × 268@25 fps), Sub stream 1 (704 × 576@25 fps), Sub stream 1 (640 × 480@25 fps), Sub stream 1 (352 × 288@25 fps), Sub stream 2 (1920 × 540@25 fps), Sub stream 2 (1280 × 960@25 fps), Sub stream 2 (1280 × 720@25 fps) 60 Hz Main stream (3840 × 1080@30 fps), Sub stream 1 (960 × 268@30 fps), Sub stream 1 (704 × 576@30 fps), Sub stream 1 (640 × 480@30 fps), Sub stream 1 (352 × 288@30 fps), Sub stream 2 (1920 × 540@30 fps), Sub stream 2 (1280 × 960@30 fps), Sub stream 2 (1280 × 720@30 fps) Details: 50 Hz Main stream (2560 × 1440@25 fps), Main stream (2048 × 1536@25 fps), Main stream (2304 × 1296@25 fps), Main stream (1920 × 1080@25 fps), Main stream (1280 × 960@25 fps), Main stream (1280 × 720@25 fps) Sub stream 1 (704 × 576@25 fps), Sub stream 1 (640 × 480@25 fps), Sub stream 1 (352 × 288@25 fps), Sub stream 2 (1280 × 720@25 fps) 60 Hz Main stream (2560 × 1440@30 fps), Main stream (2048 × 1536@30 fps), Main stream (2304 × 1296@30 fps), Main stream (1920 × 1080@30 fps), Main stream (1280 × 960@30 fps), Main stream (1280 × 720@30 fps) Sub stream 1 (704 × 480@30 fps), Sub stream 1 (640 × 480@30 fps), Sub stream 1 (352 × 240@30 fps) Sub stream 2 (1280 × 720@30 fps)</p>
<b>Bit Rate Control</b>	CBR/VBR
<b>Video Bit Rate</b>	<p>Panorama: H.264: 2,816 kbps-13,824 kbps H.265: 1,024 kbps-8,192 kbps Detail: H.264: 2,816 kbps-13,056 kbps H.265: 1,024 kbps-7,936 kbps</p>
<b>Day/Night</b>	<p>Panorama: Auto (ICR)/Color/B/W Detail: Auto (ICR)/Color/B/W</p>
<b>BLC</b>	Yes
<b>WDR</b>	<p>Panorama: Yes Detail: Yes</p>
<b>HLC</b>	Yes
<b>White Balance</b>	<p>Panorama: Auto; indoor; outdoor; ATW; manual; sodium lamp; natural light; street lamp Detail: Auto; indoor; outdoor; ATW; manual; sodium lamp; natural light; street lamp</p>
<b>Gain Control</b>	<p>Panorama: Auto/manual Detail: Auto/manual</p>
<b>Noise Reduction</b>	<p>Panorama: 2D/3D noise reduction Detail: 2D/3D noise reduction</p>
<b>Motion Detection</b>	Yes
<b>Region of Interest (RoI)</b>	Yes
<b>Image Stabilization</b>	Electronic Image Stabilization (EIS)
<b>Defog</b>	<p>Panorama: Electronic Defog Detail: Electronic Defog</p>
<b>Digital Zoom</b>	16×
<b>Image Rotation</b>	180°
<b>S/N Ratio</b>	<p>Panorama: ≥55 dB Detail: ≥55 dB</p>

<https://www.conecticplus.com/>

<b>Audio</b>	
<b>Audio Compression</b>	PCM; G.711a; G.711Mu; G.726; MPEG2-Layer2; G722.1; G729; G723
<b>Network</b>	
<b>Network Port</b>	RJ-45 (10/100 Base-T)
<b>Network Protocol</b>	FTP;RTMP;IPv6;Bonjour;IPv4;DNS;RTCP;PPPoE;NTP;RTP;802.1x;HTTPS;SNMP;TCP/IP;DDNS;UPnP;NFS;ICMP;UDP;IGMP;HTTP;SSL;DHCP;SMTP;Qos;RTSP;ARP
<b>Interoperability</b>	CGI;ONVIF (Profile S&G&T)
<b>User/Host</b>	20 (total bandwidth: 64 M)
<b>Storage</b>	FTP; Micro SD card (up to 512 G); NAS
<b>Browser</b>	IE 9 and later versions Chrome 41 and later versions Firefox 50 and later versions iOS 10 and later versions
<b>Management Software</b>	MDSS; DSS Pro
<b>Mobile Client</b>	iOS; Android
<b>Certification</b>	
<b>Certifications</b>	CE: DHQA-ESH-P22100890/DHQA-ESH-P22100654B-A1
<b>Port</b>	
<b>Audio Input</b>	1 channel (LINE IN, bare wire)
<b>Audio Output</b>	1 channel (LINE OUT, bare wire)
<b>Alarm Linkage</b>	Capture; PTZ linkage (preset; tour; pattern); recording; alarm digital input; audio; send email
<b>Alarm Event</b>	Motion/Tampering detection; audio detection; network disconnection detection; IP conflict detection; SD card abnormal detection; memory space detection; tampering detection
<b>Alarm I/O</b>	2/1
<b>Audio I/O</b>	1/1
<b>Power</b>	
<b>Power Supply</b>	36 VDC/2.23 A ± 25%
<b>Power Consumption</b>	Basic power consumption: 14 W Max. power consumption: 32 W (IR + intelligent functions + PTZ + Siren and Light Active Deterrence)
<b>Environment</b>	
<b>Operating Temperature</b>	-40 °C to +65 °C (-40 °F to +149 °F)
<b>Operating Humidity</b>	≤95%
<b>Protection</b>	IP66
<b>Structure</b>	
<b>Casing Material</b>	Plastic, aluminum alloy
<b>Product Dimensions</b>	247 mm × 202 mm × 359.8 mm (9.72" × 7.95" × 14.17") (L × W × H)
<b>Net Weight</b>	5.3 kg (11.68 lb)
<b>Gross Weight</b>	7.12 kg (15.70 lb)

**Ordering Information**

Type	Model	Description
4MP Camera	DH-SDT6C425-4P-GB-APV-0280	4MP 25× Smart Dual Light Network Panoramic PTZ Camera
	DH-SDT6C432-4P-GB-APV-0280	4MP 25× Smart Dual Light Network Panoramic PTZ Camera
Accessories	DC36V/2.23A	Power Adapter
	PFA114	Mount Adapter
	PFB303W	Wall Mount Bracket
	PFB300C	Ceiling Mount Bracket
	PFB301C	Ceiling Mount Bracket
	PFA150	Vertical Pole Mount Bracket
	PFA151	Corner Mount Bracket
	PFA150 + PFB300C	Horizontal Pole Mount Bracket
	PFB301S-E	Plane Mount Bracket
	PFB303S	Parapet Mount Bracket

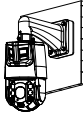
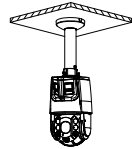
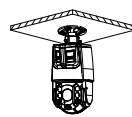
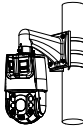
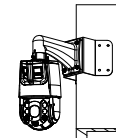
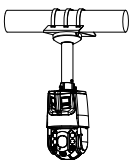
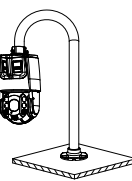
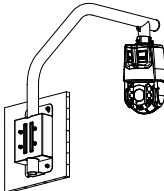
Wall Mount	Ceiling Mount	Ceiling Mount
PFA114+PFB303W+PFA120	PFA114+PFB300C	PFA114+PFB301C
		
Pole Mount (Vertical)	Corner Mount	Pole Mount (Horizontal)
PFA114+PFB303W+PFA150	PFA114+PFB303W+PFA151	PFA114+PFB300C+PFA150
		
Plane Mount	Parapet Mount	
PFA114+PFB301S-E	PFA114+PFB303S	
		

**Accessories**

Included:



DC36V/2.23A  
Power Adapter



PFA114  
Mount Adapter



PFB303W  
Wall Mount Bracket

Optional:



PFB300C  
Ceiling Mount Bracket



PFB301C  
Ceiling Mount Bracket



PFA150  
Vertical Pole Mount Bracket



PFA151  
Corner Mount Bracket



PFA150 + PFB300C  
Horizontal Pole Mount Bracket



PFB301S-E  
Plane Mount Bracket



PFB303S  
Parapet Mount Bracket

**Dimensions (mm[inch])**

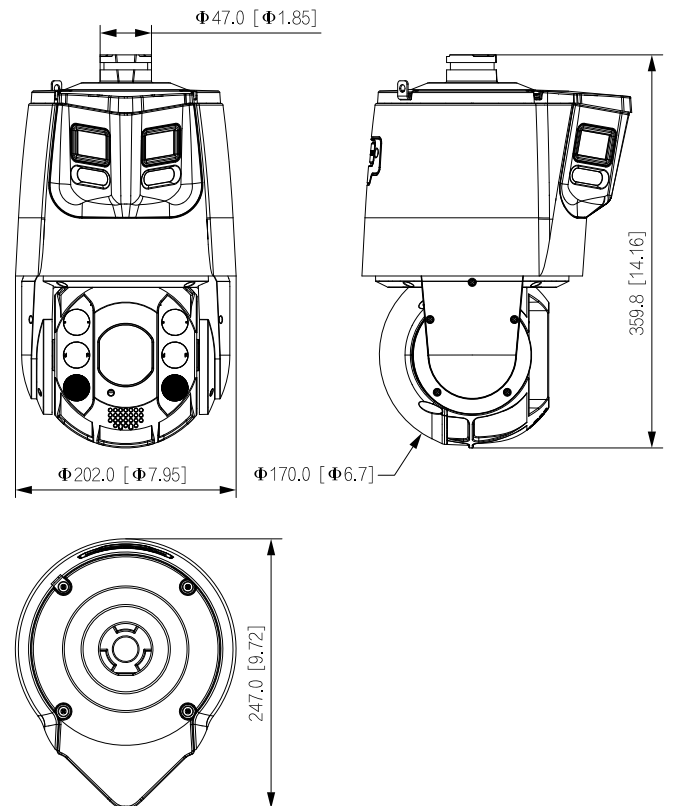

<https://www.conecticplus.com/>

Rev 002.000 © 2023 Dahua. All rights reserved. Design and specifications are subject to change without notice. The images, specifications and information mentioned in the document are only for reference, and might differ from the actual product.