

DS-2TD2138-7/QY

Anti-Corrosion Thermal Network Bullet Camera



Hikvision DS-2TD2138-7/QY Anti-Corrosion Thermal Network Bullet Camera is applied to perimeter defense and fire-prevention purposes in critical infrastructures such as airport, railway, prison, power station, 4S stores, and so on. With the vanadium oxide uncooled focal plane sensor, it enhances the thermal image quality. It adopts anti-corrosion coating to meet the requirements of used in anti-corrosion environment.

▪ Key Feature

- 384 × 288 resolution, 12 μm, VOx UFPA, NETD < 35 mK (25°C, F1.0)
- Temperature exception alarm for fire prevention, -20°C to 150°C (-4°F to 302°F), ± 8°C (± 14.4°F)
- Image processing technology: linear, histogram, self-adaptive thermal AGC mode, DDE, 3D DNR
- Behavior analysis function, based on deep learning algorithm: line crossing, intrusion, region entrance & exit
- High quality detector with 10 years guarantee



▪ Specification

Thermal Module	
Image Sensor	Vanadium Oxide Uncooled Focal Plane Arrays
Resolution	384 × 288
Pixel Pitch	12 μm
Spectral Range	8 μm to 14 μm
NETD	< 35 mK (25°C, F1.0)
Focal Length	6.5 mm
IFOV	1.85 mrad
Field of View	42.0° × 32.0° (H × V)
Min. Focusing Distance	0.6 m
Aperture	F1.1
Digital Zoom	2×, 4×, 8×
Image Effect	
Target Coloration	Yes. Supported in white hot and black hot mode.
Smart Function	
VCA	4 VCA rule types (line crossing, intrusion, region entrance, and region exiting), up to 8 VCA rules in total
Temperature Measurement	3 temperature measurement rule types, 21 rules in total (10 points, 10 areas, and 1 line)
Temperature Range	-20°C to 150°C (-4°F to 302°F)
Temperature Accuracy	± 8°C (± 14.4°F)
Video and Audio	
Main Stream	25 fps (1280 × 720, 704 × 576, 640 × 512, 352 × 288)
Sub-stream	25 fps (704 × 576, 640 × 512, 352 × 288)
Third Stream	25 fps (1280 × 720, 704 × 576, 640 × 512, 352 × 288)
Video Compression	Main Stream: H.265/H.264 Sub-Stream: H.265/H.264/MJPEG Third Stream: H.265/H.264/MJPEG
Audio Compression	G.722.1/G.711ulaw/G.711alaw/MP2L2/G.726/PCM
Network	
Protocols	IPv4/IPv6, HTTP, HTTPS, 802.1x, QoS, FTP, SMTP, UPnP, SNMP, DNS, DDNS, NTP, RTSP, RTCP, RTP, TCP, UDP, IGMP, ICMP, DHCP, PPPoE, SRTP, SFTP
API	ISAPI, HIKVISION SDK, and third-party management platform, Open Network Video Interface (Profile S, Profile G)
Security	User authentication (ID and password), MAC address binding, HTTPS encryption, IEEE 802.1x (EAP-MD5, EAP-TLS), access control, IP address filtering
Simultaneous Live View	Up to 20 channels
Client	iVMS-4200, Hik-Connect
Web Browser	Live view (plug-in allowed): Internet Explorer 11 Live view (plug-in free): Chrome 57.0 +, Firefox 52.0 + Local service: Chrome 57.0 +, Firefox 52.0 +
Network Storage	MicroSD/SDHC/SDXC card (up to 256 GB) local storage, and NAS (NFS, SMB/CIFS), auto network replenishment (ANR)
User/Host level	Up to 32 users, 3 levels: Administrator, Operator, User

Interface	
Analog Output	1.0 V [p-p]/75 Ω, PAL/NTSC/BNC
Alarm Input	2, alarm input (0 to 5 VDC)
Alarm Output	2, alarm output (alarm response actions configurable)
Alarm Action	SD recording/Relay output/Smart capture/FTP upload/Email linkage
Audio Input	1, 3.5 mm Mic in/Line in interface Line input: 2 to 2.4 V [p-p], output impedance: 1 KΩ ± 10%
Audio Output	Linear level, impedance: 600 Ω
Communication Interface	1, RJ45 10 M/100 M self-adaptive Ethernet interface 1, RS-485 interface (half duplex)
General	
Web Client Language	32 languages English, Russian, Estonian, Bulgarian, Hungarian, Greek, German, Italian, Czech, Slovak, French, Polish, Dutch, Portuguese, Spanish, Romanian, Danish, Swedish, Norwegian, Finnish, Croatian, Slovenian, Serbian, Turkish, Korean, Traditional Chinese, Thai, Vietnamese, Japanese, Latvian, Lithuanian, Portuguese (Brazil)
Power Supply	24 VAC ± 25%, 12 VDC ± 25%, two-core terminal block PoE (802.3af, class 3)
Power Consumption	24 VAC ± 25%: 0.13 A to 0.22 A, Max. 5 W 12 VDC ± 25%: 0.37 A to 0.61 A, Max. 5 W PoE (802.3af, class 3): 44 V to 57 V: 0.1 A to 0.13 A, Max. 5.5 W
Working Temperature/Humidity	Temperature: -40 °C to 65 °C (-40 °F to 149 °F) Humidity: 90% or less
Protection Level	IP67 Standard TVS 6000V lightning protection, surge protection, voltage transient protection
Dimensions	351.3 mm × 113.5 mm × 115.2 mm (13.83" × 4.47" × 4.53")
Weight	Approx. 1.77 kg (3.90 lb)

DRI Range Table

* The table is only for reference and the performance may vary according to different environment.

* The optimal detection, recognition, and identification distances are calculated according to Johnson's Criteria.

Detection Range: In order to distinguish an object from the background, the object must be covered by 1.5 or more pixels.

Recognition Range: In order to classify the object (animal, human, vehicle, etc.), the object must be covered by 6 or more pixels.

Identification Range: In order to identify the object and describe it in details, the object must be covered by 12 or more pixels.

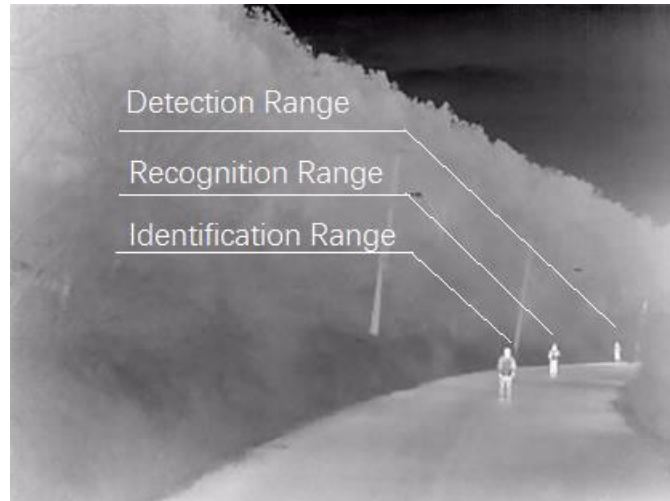

Detection Range (Vehicles: 1.4 × 4.0 m)	Detection Range (Humans: 1.8 × 0.5 m)	Recognition Range (Vehicles: 1.4 × 4.0 m)	Recognition Range (Humans: 1.8 × 0.5 m)	Identification Range (Vehicles: 1.4 × 4.0 m)	Identification Range (Humans: 1.8 × 0.5 m)
831 m	271 m	208 m	68 m	104 m	34 m

Smart Function Table

* The table is only for reference and the performance may vary according to different environment.

VCA Range (Vehicles: 1.4 × 4.0 m)	VCA Range (Humans: 1.8 × 0.5 m)	Temperature Measurement (Object: 1 × 1 m)	Temperature Measurement (Object: 0.2 × 0.2 m)
195 m	65 m	108 m	21 m

▪ Available Model

DS-2TD2138-7/QY

▪ **Dimension**

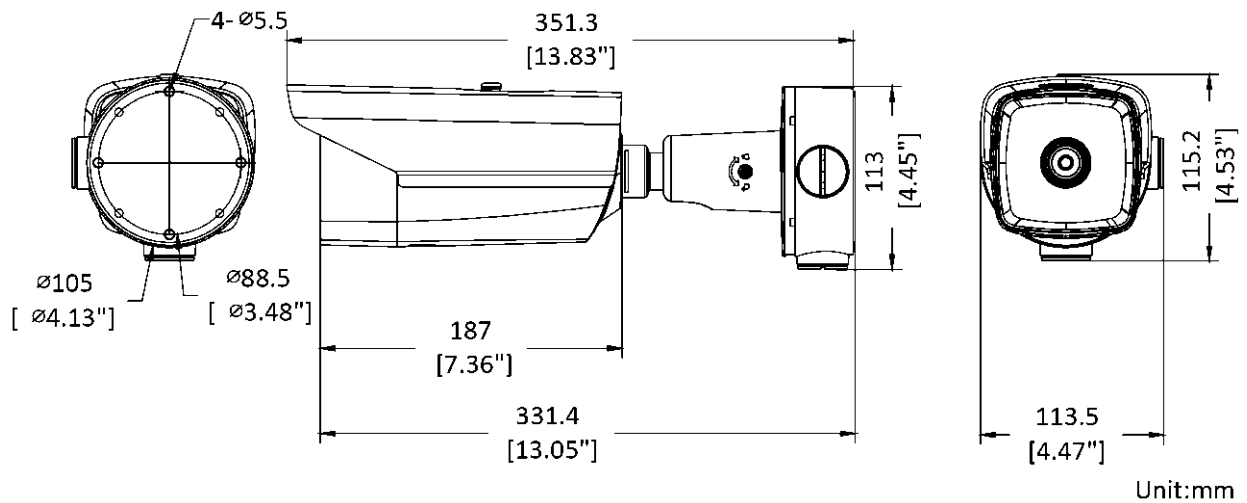

▪ **Accessory**

▪ **Included**



DS-1260ZJ
Junction Box

▪ **Optional**



DS-1276ZJ-SUS
Corner Mount



DS-1275ZJ-S-SUS
Vertical Pole Mount

COMPLIANCE NOTICE: The thermal series products might be subject to export controls in various countries or regions, including without limitation, the United States, European Union, United Kingdom and/or other member countries of the Wassenaar Arrangement. Please consult your professional legal or compliance expert or local government authorities for any necessary export license requirements if you intend to transfer, export, re-export the thermal series products between different countries.

Distributed by

**HIKVISION®****Headquarters**

No.555 Qianmo Road, Binjiang District,
Hangzhou 310051, China
T +86-571-8807-5998
overseasbusiness@hikvision.com

Hikvision USA
T +1-909-895-0400
sales.usa@hikvision.com

Hikvision Australia
T +61-2-8599-4233
salesau@hikvision.com

Hikvision India
T +91-22-28469900
sales@pramahikvision.com

Hikvision Canada
T +1-866-200-6690
sales.canada@hikvision.com

Hikvision Thailand
T +66-275-9749
sales.thailand@hikvision.com

Hikvision Europe
T +31-23-5542770
sales.eu@hikvision.com

Hikvision Italy
T +39-0438-6902
info.it@hikvision.com

Hikvision Brazil
T +55 11 3318-0050
Latam.support@hikvision.com

Hikvision Turkey
T +90 (216)521 7070- 7074
sales.tr@hikvision.com

Hikvision Malaysia
T +601-7652-2913
sales.my@hikvision.com

Hikvision UK & Ireland
T +01628-902140
sales.uk@hikvision.com

Hikvision South Africa
Tel: +27 (10) 0351172
sale.africa@hikvision.com

Hikvision France
T +33(0)1-85-330-450
info.fr@hikvision.com

Hikvision Kazakhstan
T +7-727-9730667
nikia.panfilov@hikvision.ru

Hikvision Vietnam
T +84-974270888
sales.vt@hikvision.com

Hikvision UAE
T +971-4-4432090
salesme@hikvision.com

Hikvision Singapore
T +65-6684-4718
sg@hikvision.com

Hikvision Spain
T +34-91-737-16-55
info.es@hikvision.com

Hikvision Tashkent
T +99-87-1238-9438
uzb@hikvision.ru

Hikvision Hong Kong
T +852-2151-1761
info.hk@hikvision.com

Hikvision Russia
T +7-495-669-67-99
saleru@hikvision.com

Hikvision Korea
T +82-(0)31-731-8817
sales.korea@hikvision.com

Hikvision Poland
T +48-22-460-01-50
info.pl@hikvision.com

Hikvision Indonesia
T +62-21-2933759
Sales.Indonesia@hikvision.com

Hikvision Colombia
sales.colombia@hikvision.com