

DH-HAC-HDBW2241F-A

2MP Starlight HDCVI IR Dome Camera

HDCVI



- Starlight, 120dB true WDR, 3DNR
- Max. 30fps@1080P
- HD/SD output switchable
- Audio in interface, built-in mic
- 3.6mm fixed lens (2.8mm optional)
- Max. IR length 20m, Smart IR
- IP67, IK10, DC12V±30%



System Overview

Experience 1080P full HD video and the simplicity of reusing existing coaxial infrastructure with HDCVI. The Starlight HDCVI camera with 120dB true WDR presents a high quality image with rich details even in extreme low-light conditions. It offers various motorized/fixed lens models with a multi-language OSD and HD/SD switchable output. Its superior image performance and starlight feature makes the camera an ideal choice for mid to large-size businesses and projects where both highly reliable surveillance and construction flexibility are needed.

Functions

4 Signals over 1 Coaxial Cable

HDCVI technology supports 4 signals to be transmitted over 1 coaxial cable simultaneously, i.e. video, audio*, data and power. Dual-way data transmission allows the HDCVI camera to interact with the HCVR, such as sending control signal or triggering alarm. Moreover, HDCVI technology supports PoC for construction flexibility.

* Audio input is available for some models of HDCVI cameras.

Long Distance Transmission

HDCVI technology guarantees long-distance and real-time transmission without any loss. It supports up to 800m for 1080P Full HD video via coaxial cable, and up to 300m via UTP cable.*

*Actual results verified by real-scene testing in Dahua's test laboratory.

Simplicity

HDCVI technology inherits the born feature of simplicity from traditional analog surveillance system, making itself a best choice for investment protection. HDCVI system can seamlessly upgrade the traditional analog system without replacing existing coaxial cabling. The plug and play approach enables full HD video surveillance without the hassle of configuring a network.

Starlight

With the adoption of high performance sensor, the camera is able to provide incomparable performance even under extreme lowlight environment. The starlight feature allows more details to be captured and accurate color to be recognized at night or in scenes with limited illumination.

<https://www.conecticplus.com/>

Broadcast-quality Audio

Audio information is used as supplementary evidence in video surveillance applications. The HDCVI camera supports audio signal transmission over coaxial cable. In addition, it adopts unique audio processing and transmission technology that best restores source audio and eliminates noise, guaranteeing the quality and effectiveness of collected audio information.

Multi-formats

The camera supports multiple video formats including HDCVI, CVBS and other two common HD analog formats in the market. The four formats can be switched over through OSD menu or by PFM820 (UTC controller). This feature makes the camera to be compatible with not only HCVRs but also most end users' existing HD/SD DVRs.

Wide Dynamic Range

Embedded with industry leading wide dynamic range (WDR) technology, vivid pictures are achieved even in the most intense contrast lighting conditions. True WDR (120dB) optimizes both the bright and dark areas of a scene at the same time to provide usable video.

Advanced 3DNR

3DNR is noise reduction technology that detects and eliminates random noises by comparing two sequential frames. Dahua's advanced 3DNR technology allows remarkable noise reduction with little impact to sharpness, especially under limited lighting condition. Besides, the advanced 3DNR effectively decreases the band width and saves the storage space.

Protection

The camera's outstanding reliability is unsurpassed due to its rugged design. The camera is protected against water and dust with IP67 ranking, making it suitable for indoor or outdoor environments.

The camera complies with an IK10 vandal resistance rating making it capable of withstanding the equivalent of 5 kg (11.02 lbs) of force dropped from a height of 40 cm (15.75 in).

Supporting ±30% input voltage tolerance, this camera suits even the most unstable power supply conditions. Its 4KV lightning rating provides protection against the camera and its structure from the effects of lightning.

Technical Specification

Camera

Image Sensor	1/2.8" CMOS
Effective Pixels	1920(H)×1080(V), 2MP
Scanning System	Progressive
Electronic Shutter Speed	PAL: 1/4s~1/100000s NTSC: 1/3s~1/100000s
Minimum Illumination	0.004Lux/F1.6, 30IRE, 0Lux IR on
S/N Ratio	More than 65dB
IR Distance	Up to 20m (66feet)
IR On/Off Control	Auto / Manual
IR LEDs	8

Lens

Lens Type	Fixed lens / Fixed iris
Mount Type	Board-in
Focal Length	3.6mm (2.8mm Optional)
Max Aperture	F1.6
Angle of View	H: 86.9° (110°)
Focus Control	N/A
Close Focus Distance	1200mm (500mm) 47.2" (19.7")

DORI Distance

*Note: The DORI distance is a "general proximity" of distance which makes it easy to pinpoint the right camera for your needs. The DORI distance is calculated based on sensor specification and lab test result according to EN 62676-4 which defines the criteria for Detect, Observe, Recognize and Identify respectively.

	DORI Definition	Distance
Detect	25px/m (8px/ft)	2.8mm: 39m(128ft) 3.6mm: 55m(180ft)
Observe	63px/m (19px/ft)	2.8mm: 15m(49ft) 3.6mm: 22m(72ft)
Recognize	125px/m (38px/ft)	2.8mm: 8m(26ft) 3.6mm: 11m(36ft)
Identify	250ppm (76px/ft)	2.8mm: 4m(13ft) 3.6mm: 6m(20ft)

Pan / Tilt / Rotation

Pan/Tilt/Rotation	Pan: 0° ~ 60° Tilt: 0° ~ 80° Rotation: 0° ~ 360°
-------------------	--

Video

Resolution	1080P (1920×1080)
Frame Rate	25/30fps@1080P, 25/30/50/60fps@720P
Video Output	1-channel BNC high definition video output / CVBS video output (DIP switch)
Day/Night	Auto (ICR) / Manual

<https://www.conecticplus.com/>

OSD Menu	Multi-language
BLC Mode	BLC / HLC / WDR
WDR	120dB
Gain Control	AGC
Noise Reduction	2D / 3D
White Balance	Auto / Manual
Smart IR	Auto / Manual

Certifications

Certifications	CE (EN55032, EN55024, EN50130-4) FCC (CFR 47 FCC Part 15 subpartB, ANSI C63.4-2014) UL (UL60950-1+CAN/CSA C22.2 No.60950-1)
----------------	---

Interface

Audio Interface	1ch in & Built-in Mic
-----------------	-----------------------

Electrical

Power Supply	12V DC ±30%
Power Consumption	Max. 4.3W (12V DC, IR on)

Environmental

Operating Conditions	-40°C ~ +60°C (-40°F ~ +140°F) / Less than 95% RH * Start up should be done at above-40°C (-40°F)
Storage Conditions	-40°C ~ +60°C (-40°F ~ +140°F) / Less than 95% RH
Ingress Protection & Vandal Resistance	IP67 & IK10

Construction

Casing	Aluminium
Dimensions	Φ106mm×50.3mm (Φ4.17"×1.98")
Net Weight	0.31kg (0.68lb)
Gross Weight	0.45kg (0.99lb)

Ordering Information

Type	Part Number	Description
2MP Camera	DH-HAC-HDBW2241FP-A 2.8mm	2MP Starlight HDCVI IR Dome Camera, PAL
	DH-HAC-HDBW2241FP-A 3.6mm	2MP Starlight HDCVI IR Dome Camera, PAL
	DH-HAC-HDBW2241FN-A 2.8mm	2MP Starlight HDCVI IR Dome Camera, NTSC
	DH-HAC-HDBW2241FN-A 3.6mm	2MP Starlight HDCVI IR Dome Camera, NTSC
Accessories	PFA139	Junction box (For use alone)
	PFB204W	Wall mount (For use alone or with PFA152-E pole mount)
	PFA152-E	Pole mount (For use with PFB204W junction box)
	PFM800-E	Passive HDCVI Balun
	PFM321	12V 1A Power Adapter
	PFM320	12V 2A Power Adapter
	PFM300	12V 2A Power Adapter

Accessories

Optional:



PFA139
Junction box



PFB204W
Wall mount



PFA152-E
Pole mount



PFM800-E
Passive HDCVI Balun



PFM321
12V 1A Power Adapter



PFM320
12V 2A Power Adapter



PFM300
12V 2A Power Adapter

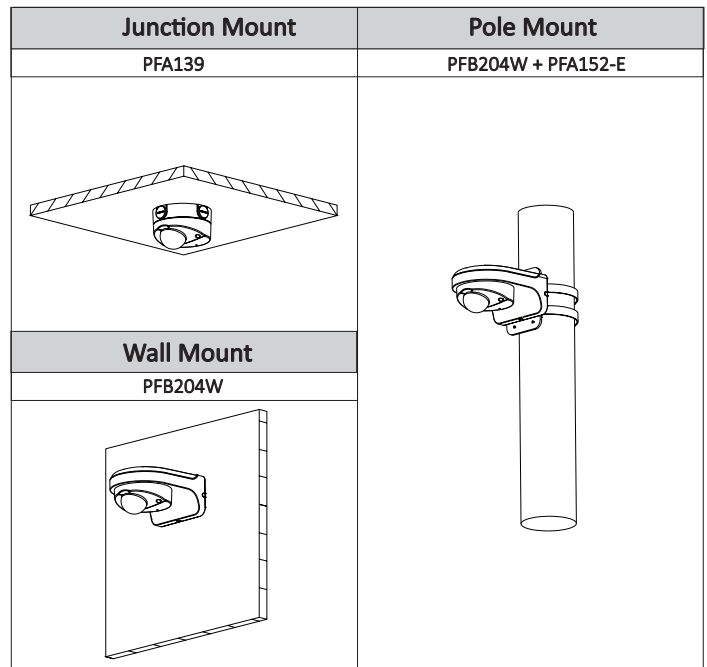

Dimensions (mm/inch)

