

DS-2CE57H8T-VPITF 5 MP Ultra Low Light Vandal Fixed Dome Camera



- 5 MP high performance dome camera
- Strong night performance, capturing images in ultra-low light down to 0.003 lux
- Clear imaging even against strong back lighting due to 130 dB true WDR technology
- 3D DNR technology delivers clean and sharp images
- EXIR 2.0: advanced infrared technology with 30 m IR distance
- Water and dust resistant (IP67) and vandal proof (IK10)
- 4 in 1 (4 signals switchable TVI/AHD/CVI/CVBS)

▪ Specification

Camera	
Image Sensor	5 MP CMOS
Max. Resolution	2560 (H) × 1944 (V)
Min. Illumination	Color: 0.003 Lux@(F1.6, AGC ON), 0 Lux with IR
Shutter Time	PAL: 1/25 s to 1/50,000 s;NTSC: 1/30 s to 1/50,000 s
Day & Night	IR Cut Filter
Angle Adjustment	Pan: 0° to 355°, Tilt: 0° to 75°, Rotate: 0° to 355°
Signal System	PAL/NTSC
Lens	
Lens Type	2.8 mm, 3.6 mm and 6 mm fixed focal lens
Focal Length & FOV	2.8 mm, horizontal FOV: 98° 3.6 mm, horizontal FOV: 78° 6 mm, horizontal FOV: 48°
Lens Mount	M12
Illuminator	
Supplement Light Type	IR
Supplement Light Range	Up to 30 m
Smart Supplement Light	Yes
Image	
Image Settings	Brightness,Mirror,Smart IR,Sharpness,AGC
Frame Rate	TVI: 2 MP@25fps, 2 MP@30fps, 4 MP@25fps, 4 MP@30fps, 5 MP@20fps AHD: 4 MP@25fps, 4 MP@30fps, 5 MP@20fps CVI: 4 MP@25fps, 4 MP@30fps CVBS: PAL, NTSC
Day/Night Mode	Auto/Color/BW (Black and White)
Wide Dynamic Range (WDR)	≥130 dB
Image Enhancement	WDR,BLC
Privacy Mask	4 programmable privacy masks
Noise Reduction	3D DNR
White Balance	Auto/Manual
Interface	
Video Output	Switchable TVI/AHD/CVI/CVBS,1 HD analog output
Event	
Motion Detection	4 programmable motion areas
General	
Power	12 VDC ± 25%, max. 5.8 W *You are recommended to use one power adapter to supply the power for one camera.
Material	Metal
Dimension	Φ 110.8 mm × 84.7 mm (Φ 4.4" × 3.3")
Weight	Approx.500 g (1.10 lb.)
Operating Condition	-40 °C to 60 °C (-40 °F to 140 °F), humidity: 90% or less (non-condensing)
Communication	HIKVISION-C

Language	English
Approval	
Protection	IP67, IK10

▪ **Available Model**

DS-2CE57H8T-VPITF(2.8mm)

DS-2CE57H8T-VPITF(3.6mm)





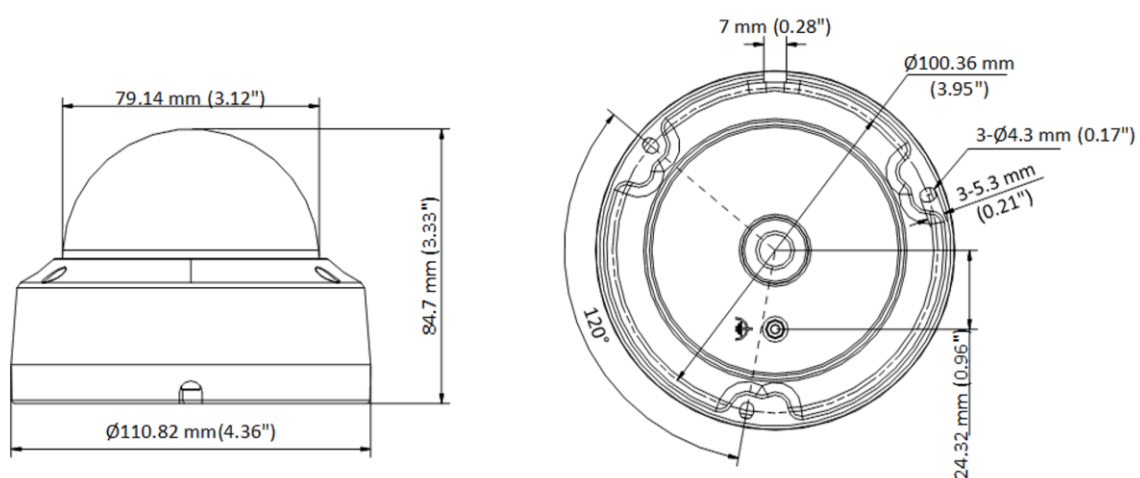





DS-2CE57H8T-VPITF(6mm)

▪ **Dimension**



▪ **Accessory**

▪ **Optional**

DS-1253ZJ-M Rain Shade	DS-1250ZJ Rain Shade	DS-1259ZJ Inclined Ceiling Mount	DS-1280ZJ-DM18 Junction Box	DS-1276ZJ-SUS Corner Mount
				
DS-1275ZJ-SUS Vertical Pole Mount	DS-1271ZJ-110 Pendant Mount	DS-1272ZJ-110 Wall Mount	DS-1258ZJ Wall Mount	DS-1272ZJ-110B Wall Mount
				

Headquarters

No.555 Qianmo Road, Binjiang District,
Hangzhou 310051, China
T +86-571-8807-5998
www.hikvision.com



Follow us on social media to get the latest product and solution information.



Hikvision



HikvisionHQ



HikvisionHQ



Hikvision_Global



Hikvision
Corporate Channel



hikvisionhq

<https://www.conecticplus.com/>