

genkinno

P2

Robotic Pool Cleaner

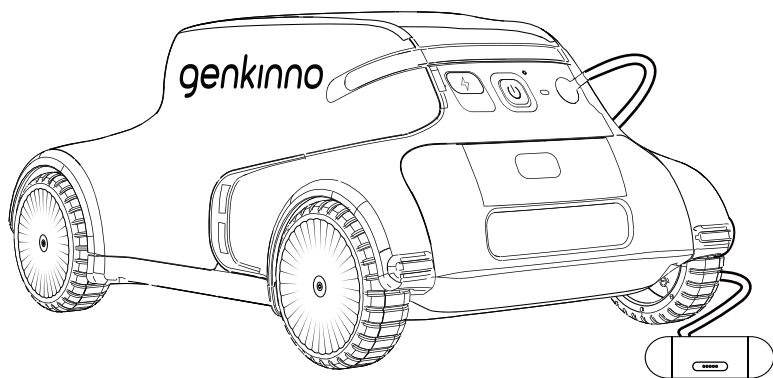

User Manual

English

Thank you for choosing the genkinno robotic pool cleaner.

This user manual helps you to keep your robot performing at its best. Please take a few moments to read through it.

If you have any questions, contact our customer service for assistance or visit www.genkinno.com for more information.

Genkinno Customer Service:

Email: support@genkinno.com

Facebook: @genkinno



Tutorial Videos



APP Download

CONTENTS

1. Unboxing Checklist	02
1.1 In the Box	02
1.2 Robotic Pool Cleaner Parts	02
1.3 Water Conditions	03
2. Using for the First Time	03
2.1 Charging the Cleaner	03
2.2 Turning on the Cleaner	03
2.3 Checking the Battery Level	04
2.4 Placing the Robotic Pool Cleaner into the Pool	04
2.5 Auto Parking	04
2.6 Taking the Robotic Pool Cleaner out from the Pool	04
2.7 Filter Cleaning After Use	05
2.8 Robotic Pool Cleaner Charging	05
3. More product operating instructions	06
3.1 Robotic Pool Cleaner Status Indicator	06
3.2 Auto Mode	06
3.2.1 Power Auto Switch	06
3.3 Manual Mode	07
3.3.1 Remote Controller Parts	07
3.3.2 Using the Remote Controller for the First Time	07
3.3.3 Switching to Manual Mode	08
3.3.4 Start/Pause Control	08
3.3.5 Controlling the Cleaner	08
3.3.6 Remote Controller Status LED	09
4. Genkinno APP	09
4.1 APP Download & Registration	10
4.2 Binding the Cleaner	10
4.3 Upgrading Firmware	11
5. Storage	11
6. Specifications	12
7. FAQs	13
8. Warning and Cautions	14
9. Warranty	16

1. Unboxing Checklist

1.1 In the Box

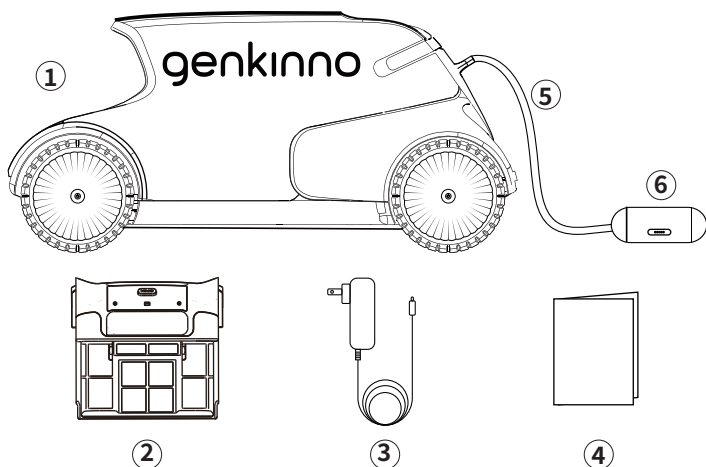

- | | |
|---|----------------------|
| ① 1 * Genkinno P2 | ④ 1 * User Manual |
| ② 1 * Water Filter Tank (Filter Included) | ⑤ 1 * Floating Cable |
| ③ 1 * Charger | ⑥ 1 * Handle |

1.2 Robotic Pool Cleaner Parts

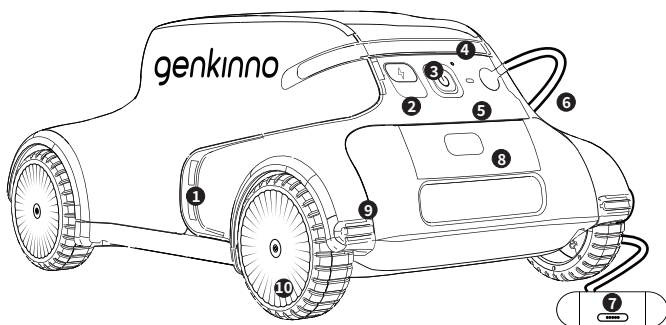

- | | |
|----------------------|--------------------------|
| 1. Drain | 6. Floating cable |
| 2. Charge Input | 7. Handle |
| 3. Power Button | 8. Release Button |
| 4. Battery Level LED | 9. Anti-collision Rubber |
| 5. Function LED | 10. Wheel |

1.3 Water Conditions

Use the Robotic Pool Cleaner in the following water conditions:

pH	7.0 – 7.8
Temperature	0°C – 40°C
NaCl	5000 ppm, Max

2. Using for the First Time

2.1 Charging the Cleaner

Before using it for the first time, connect the cleaner and the included charger to charge the battery.

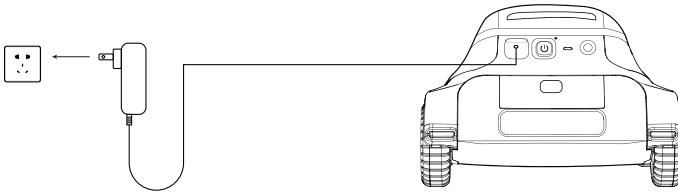

- Before charging, check the charging port and keep it dry.
- When the red indicator light of the adapter is on, the battery is currently charging.
- When the green indicator light of the adapter is on, charging has been completed.

2.2 Turning on the Cleaner

Press the start button once to power on the cleaner.

When the white light flashes, the cleaner is in preheating mode.

After about 30 seconds, the cleaner's indicator light turns constant blue, indicating that the cleaner is ready to start working.

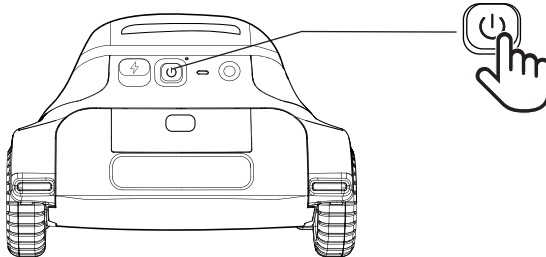

2.3 Checking the Battery Level

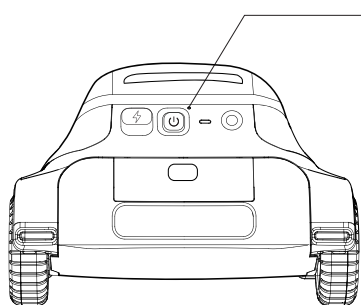

Green: The cleaner can work normally.
Red: The battery level is low, and the battery requires recharging.

2.4 Placing the Robotic Pool Cleaner into the Pool

Release it slowly and let it sink steadily to the floor of the pool.

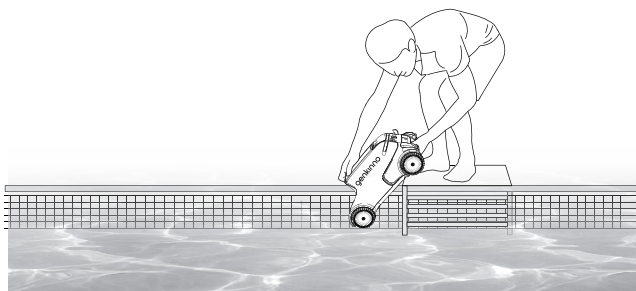

2.5 Auto Parking

When the battery is low, it will park itself so that you can easily take it out.

2.6 Taking the Robotic Pool Cleaner out from the Pool

Locate and grab the floating cable, you can then pull the cable to take the cleaner out from the swimming pool.

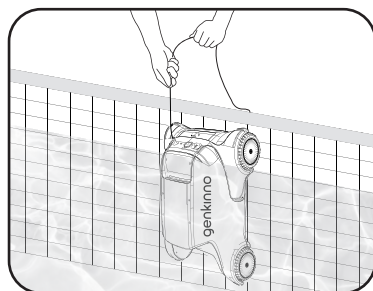

2.7 Filter Cleaning After Use

It is highly recommended to clean the filter after each cleaning cycle.



1
Press the button 

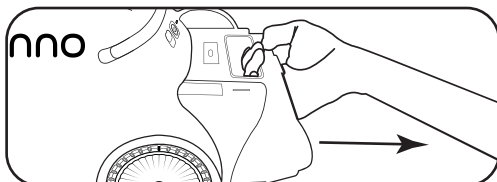

2
Pull out of the
water filter tank.

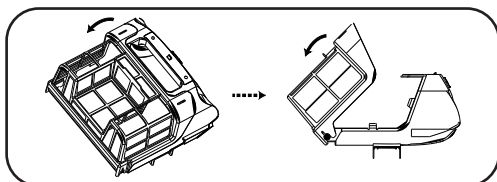

3
Open the water filter tank.

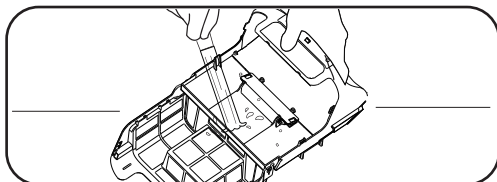

4
Clean the water filter tank.
It is recommended to
thoroughly clean both sides
of the filter.

2.8 Robotic Pool Cleaner Charging

- After each use, please promptly charge the cleaner to ensure its readiness for the next use.
- Before charging, please make sure the charging port is dry.
- Once fully charged, remember to promptly attach the charging plug.

3. More product operating instructions

3.1 Robotic Pool Cleaner Status Indicators

The cleaner includes LED status indicators. The table below describes the machine status indicated by different flashing methods.

P2 Status Indicator	
Blue flashing slowly	Auto Mode, Pause
Blue constant	Auto Mode, Start
Green flashing slowly	Manual Mode, Pause
Green constant	Manual Mode, Start
White flashing	The cleaner is preheating, and cleaning operations will commence after the preheating process is complete.
Red constant	Low battery

3.2 Auto Mode

Once turned on, the cleaner enters Auto Mode by default, where the cleaner begins to operate approximately 0.5 to 1 minutes after being placed inside the pool.

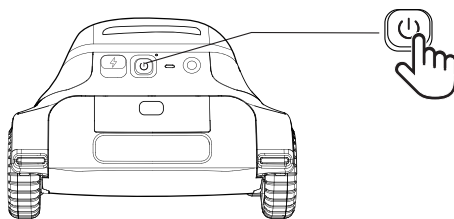

3.2.1 Auto Power Mode Switch

- The default power of the cleaner is 40W;
- The cleaner's maximum suction power of 70W will be activated automatically when the cleaner encounters large leaves and other debris.

3.3 Manual Mode (Remote control needs to be purchased separately)

3.3.1 Remote Controller Parts

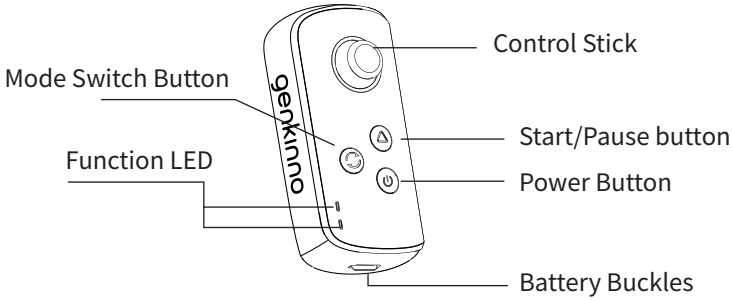

3.3.2 Using the Remote Controller for the First Time

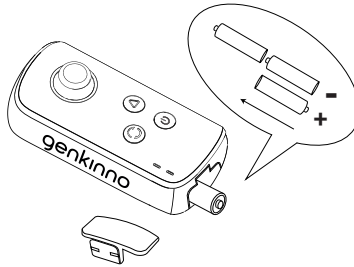

Please insert three AA batteries into the remote controller as shown in the diagram, and then pair the remote controller with the robotic pool cleaner.

- ① Press and hold the power button until the remote controller turns on.
- ② Then press and hold the mode switch button for 5 seconds, wait until the green and blue lights alternate flashing.
- ③ Turn on the cleaner, wait to hear a "beep-," and see the remote controller LED light turn constant state, indicating successful pairing.

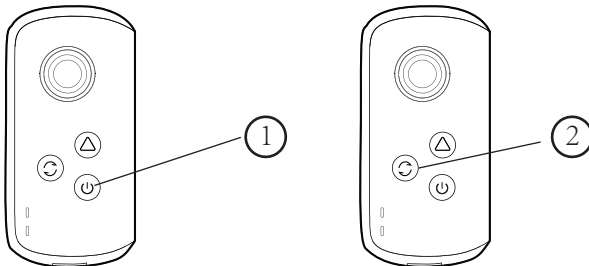

3.3.3 Switching to Manual Mode

Turn on the remote controller, press the Mode button. The LED indicator turns green, indicating that the cleaner is switched to manual mode.

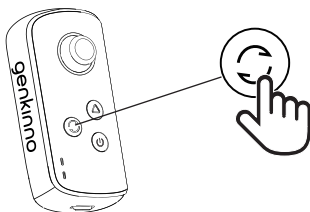

3.3.4 Start/Pause Control

Press the Start/Pause button to control the cleaner's start and pause. When the indicator light is green/blue constant, the cleaner is turned on. When the indicator light is flashing, the cleaner has paused working.

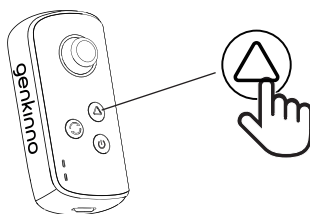

3.3.5 Controlling the Cleaner

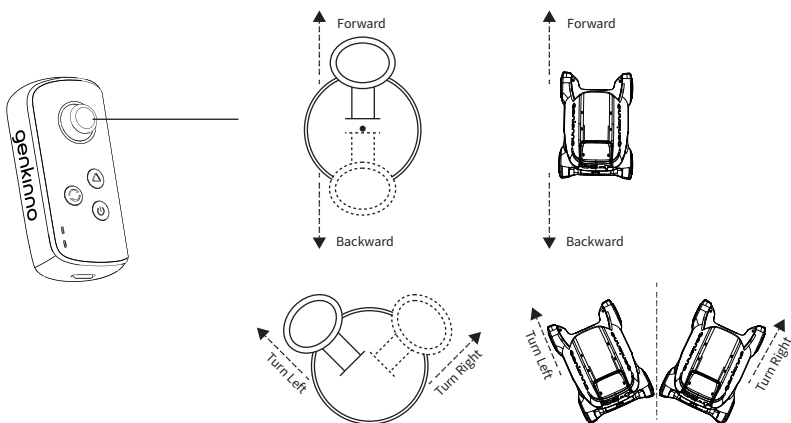

3.3.6 Remote Controller Status LED

RC Status Indicator	
Blue flashing slowly	Auto Mode, Pause
Blue constant	Auto Mode, Start
Green flashing slowly	Manual Mode, Pause
Green constant	Manual Mode, Start
Red flashing	Remote controller and cleaner disconnected
Red constant	Low battery
Blue and green LED alternating slow flashes	Pairing Status

4. Genkinno App

The Genkinno P2 supports connecting to the app for managing the Cleaner. Search for "Genkinno" on Google Play or App Store to download and install the app on your phone.

You can access the following services:

- Manage the Cleaner and perform firmware upgrades.
- Obtain pool and Cleaner maintenance knowledge for better pool management.
- Contact the official support team to receive timely technical assistance.

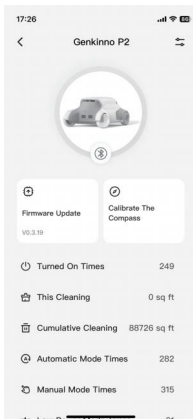

Device Page

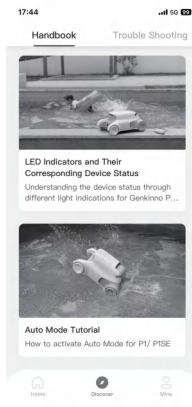

Knowledge Page

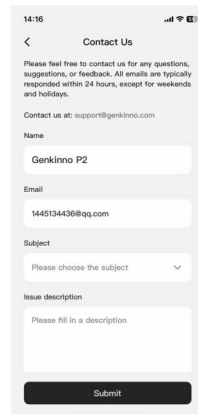

Contact Us Page

4.1 APP Download & Registration

Before using it for the first time, you can scan the code or search for "Genkinno" on App Store or Google Play to download the Genkinno App. Then, follow the prompts to register or log in to your account.



APP Download

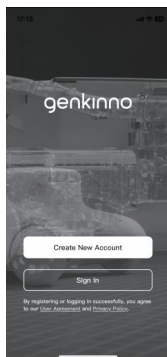

Create New Account

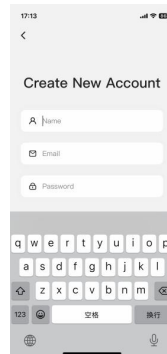

Registration Page

4.2 Binding the Cleaner

To power on the cleaner, open the app and tap Add New Device. Then select Genkinno P2 to enter the search page. Once the list displays the relevant product name, tap to complete the initial binding process.

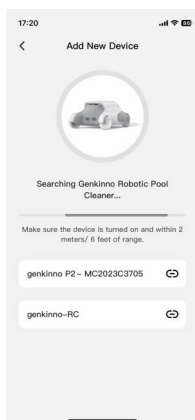

Search Page



Add New Device

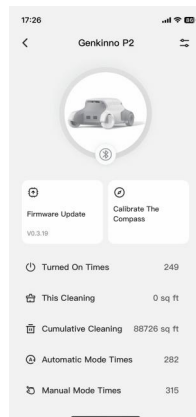

Device Page

4.3 Upgrading Firmware

Tap **Firmware Upgrade** to update the firmware to the latest version. This process takes approximately 3~4 minutes.

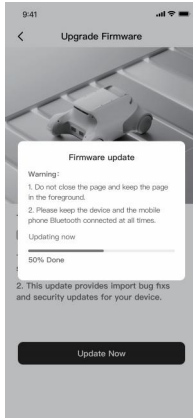

Firmware Update

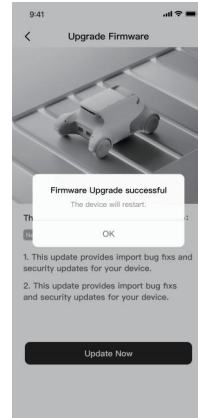

Firmware Upgrade Successful

5. Storage

- Please ensure that the cleaner is turned off.
- Ensure that no water is left inside the cleaner and keep it dry.
- Thoroughly clean the filter net and cleaner.
- Store the cleaner indoor away from direct sunlight or weather elements such as rain or frost.
- If the cleaner needs to be stored for a long period of time, it should be charged every three months to maintain battery life between 40%~60%.
- During winter, please store the cleaner indoors to prevent any damage to the cleaner.

6. Specifications

PC102	
Product Size	415×276×200 mm
Weight	4.6 kg
Max Water Depth	9 ft
Run Time	120 min (with 147 μm filter)
Max Pool Size	100 m ² / 1076 sq ft
Pool Water Temperature	0°C–40°C
PH	7.0–7.8
Max Pool Slope	15°
Storage Temperature	-20°C–45°C, RH ≤ 75%
Cleaning Module	
Cleaning Power	40 W (Default)
Filter Capacity	2.4 L
Filter Density	147 μm
Cleaning Coverage	Only Floor
Cleaning Mode	Auto Mode/Manual Mode
Speed	0.2 m/s
Battery	
Battery Capacity	9000 mAh (97.2 Wh)
Voltage	10.8 V
Adapter Output	12.6 V
Battery Type	3S3P
Charging Environment Temperature	-10°C–40°C
Charging Time	3–3.5h
Remote	
Run Time	30 h
Max Control Distance	30 m
Environment Temperature	0°C–40°C

7. FAQs

Symptom	Corrective Action
The cleaner cannot power on	1. The cleaner cannot power on while being connected to the charger. Please unplug the charger and try to power it on again.
	2. If the issue persists, it might be due to the cleaner's battery being depleted. Connect the charger to charge the cleaner. Once the charger indicator light changes from red to green, unplug the charger and attempt to power it on again.
The cleaner cannot charge	1. Check if the charger is in good condition. First, plug the charger directly into a power source and observe if the indicator light on the charger is illuminated. If the charger's indicator light doesn't turn on, the charger is faulty.
	2. If the power indicator light is functioning properly and the cleaner's power indicator light turns green when connected to the power source, there might be an issue with the cleaner. Please contact us for assistance: support@genkinno.com
The cleaner cannot move	1. If the cleaner's battery indicator light is red, the cleaner is running out of battery. Please charge the cleaner.
	2. If the cleaner's battery indicator light is green, please check the filter net in the filter water tank to ensure it is not blocked.
When the cleaner is powered on, status light is flashing white	1. When the cleaner's power is turned on and the white light is flashing, the cleaner is in the startup process. Wait for about 1 minute, and once the cleaner's light turns constant blue, the cleaner is ready to perform the cleaning tasks.
The remote controller cannot control the cleaner	The remote controller and the cleaner may not be paired. Please follow the user manual to pair the cleaner and remote controller and then try again.

8. Warning and Cautions

IMPORTANT SAFETY INSTRUCTIONS, READ AND FOLLOW ALL INSTRUCTIONS!

8.1 Please adhere strictly to the following WARNINGS:

- Only use the accessories recommended or sold by the manufacturer.
- Do not allow children to ride on the cleaner or play with it.
- Use the original and authorized power adapter only.
- The charging adapter must be connected to a leakage-protected socket when charging.
- Do not operate the cleaner when people or animals are in the pool.
- While charging, the cleaner should be uncovered and kept in a cool place in order to prevent damage of internal electrical components caused by overheating.
- Only certified professionals can disassemble the sealed driving kit of the cleaner.
- Do not operate the cleaner while the pool filter is running.
- Oil sealant for the servo contains grease, which can cause water pollution if exposed.
- If the cleaner needs to be stored for a long period of time, it should be charged every three months to maintain battery life between 40%-60%.
- Please use the original and authorized power adapter only. If the cleaner is not charged for a long time, the battery voltage will be lower than the over-discharge protection voltage due to the self-discharge of the battery, which may cause fatal damage.
- Do not use or store the cleaner near any heat source.
- Do not pierce the shell of the cleaner with nails or other sharp objects.
- Do not hammer, impact, or throw the cleaner.
- Make sure the charging socket is dried before charging.

FCC Caution

- Any Changes or modifications not expressly approved by the party responsible for compliance could void the user's authority to operate the equipment.
- This device complies with part 15 of the FCC Rules. Operation is subject to the following two conditions: (1) This device may not cause harmful interference, and (2) this device must accept any interference received, including interference that may cause undesired operation.
- This radio is designed for and classified as "General population/uncontrolled Use", the guidelines are based on standards that were developed by independent scientific organizations through periodic and thorough evaluation of scientific studies. The standards include a substantial safety margin designed to assure the safety of all persons regardless of age or health.

- Body and limbs operation; this device was tested for typical body and limbs operations kept 0mm for body worn. To maintain compliance with RF exposure requirements, use accessories that maintain a 0mm for body worn. EN

- Note: This equipment has been tested and found to comply with the limits for a Class B digital device, pursuant to part 15 of the FCC Rules. These limits are designed to provide reasonable protection against harmful interference in a residential installation. This equipment generates, uses and can radiate radio frequency energy and, if not installed and used in accordance with the instructions, may cause harmful interference to radio communications.

However, there is no guarantee that interference will not occur in a particular installation. If this equipment does cause harmful interference to radio or television reception, which can be determined by turning the equipment off and on, the user is encouraged to try to correct the interference by one or more of the following measures:

- Reorient or relocate the receiving antenna.
- Increase the separation between the equipment and receiver.
- Connect the equipment into an outlet on a circuit different from that to which the receiver is connected.
- Consult the dealer or an experienced radio/TV technician for help.
- This appliance can be used by children aged from 8 years and above and persons with reduced physical, sensory or mental capabilities or lack of experience and knowledge if they have been given supervision or instruction concerning use of the appliance in a safe way and understand the hazards involved.
- Children shall not play with the appliance.
- Cleaning and user maintenance shall not be made by children without supervision.

8.2 Please ensure that the following PRECAUTIONS are implemented:

- Check the wheels to make sure they turn properly.
- Always clean and wash the filter tray after using.
- Turn off the cleaner when maintaining, cleaning, or when it is not in use.
- The cleaner should be stored in a cool and ventilated place, away from direct sunshine.
- Due to the limitations of the battery capacity, the cleaner is only suitable for swimming pools with sizes up to 1076 sq. ft (100m²); otherwise, the cleaning effect will be impacted or reduced.

9. Warranty

This product has passed all quality control and safety tests in accordance with all relevant laws and regulations and the highest safety standards.

Warranty Information:

- This warranty is voided if the product has been altered, misused, or has been repaired by unauthorized personnel.
- The warranty extends only to manufacturing defects and does not cover any damage resulting from mishandling of the product by the owner.
- The order number or record must be presented for any claim or repair during the warranty period.

Warranty period

Part	Northern America	Europe	Australia	Other Countries or areas
Motor	2 years	2 years	2 years	2 years
Battery	2 years	2 years	2 years	2 years

Genkinno support:

<https://genkinno.com/pages/support>

Genkinno service:

If you have any questions about this document, please contact genkinno by sending a message to support@genkinno.com

Facebook: [@genkinno](https://www.facebook.com/genkinno)