



**Electrolux**



[electrolux.com/register](https://electrolux.com/register)



**EN** User Manual | **Washing Machine**

**EW6FI22914OV**



# Welcome to Electrolux! Thank you for choosing our appliance.



Get usage advice, brochures, trouble shooter, service and repair information:  
[www.electrolux.com/support](http://www.electrolux.com/support)

Subject to change without notice.

## CONTENTS

1. SAFETY INFORMATION.....	2
2. SAFETY INSTRUCTIONS.....	4
3. PRODUCT DESCRIPTION.....	6
4. TECHNICAL DATA.....	7
5. INSTALLATION.....	7
6. ACCESSORIES.....	11
7. CONTROL PANEL.....	12
8. DIAL AND BUTTONS.....	13
9. PROGRAMMES.....	16
10. SETTINGS.....	20
11. BEFORE FIRST USE.....	21
12. DAILY USE.....	21
13. HINTS AND TIPS.....	26
14. CARE AND CLEANING.....	27
15. TROUBLESHOOTING.....	33
16. CONSUMPTION VALUES.....	36
17. QUICK GUIDE.....	37
18. ENVIRONMENTAL CONCERNS.....	39

## 1. ⚠ SAFETY INFORMATION



Before beginning the installation and use of this appliance, carefully read the supplied instructions. The manufacturer is not responsible for any injuries or damage that are the result of incorrect installation or usage. Always keep the instructions in a safe and accessible location for future reference.

### 1.1 Children and vulnerable people safety

- This appliance can be used by children aged from 8 years and above and persons with reduced physical, sensory or mental capabilities or lack of experience and knowledge if they have been given supervision or instruction concerning

the use of the appliance in a safe way and understand the hazards involved.

- Children between 3 and 8 years of age and persons with very extensive and complex disabilities shall be kept away from the appliance unless continuously supervised.
- Children of less than 3 years of age should be kept away from the appliance unless continuously supervised.
- Children should be supervised to ensure that they do not play with the appliance.
- Keep all packaging away from children and dispose of it appropriately.
- Keep detergents away from children.
- Keep children and pets away from the appliance when the door is open.
- If the appliance has a child safety device, it should be activated.
- Children shall not carry out cleaning and user maintenance of the appliance without supervision.

## **1.2 General Safety**

- This appliance is for washing domestic-type, machine-washable laundry only.
- This appliance is designed for single household domestic use in an indoor environment.
- This appliance may be used in, offices, hotel guest rooms, bed & breakfast guest rooms, farm guest houses and other similar accommodation where such use does not exceed (average) domestic usage levels.
- Do not change the specification of this appliance.
- The appliance maximum load is 9 kg. Do not exceed the maximum load of each programme (refer to the “Programmes” chapter).
- The operating water pressure at the water entry point from the outlet connection must be between 0.5 bar (0.05 MPa) and 10 bar (1.0 MPa).

- The ventilation opening in the base must not be covered by a carpet, mat, or any floor covering.
- The appliance must be connected to the water mains using the new supplied hose sets, or other new hose sets supplied by the Authorised Service Centre.
- Old hose sets must not be reused.
- If the mains power supply cable is damaged, it must be replaced by the manufacturer, its Authorised Service Centre or similarly qualified persons to avoid an electrical hazard.
- Before any maintenance operation, deactivate the appliance and disconnect the mains plug from the socket.
- Do not use high pressure water sprays and/or steam to clean the appliance.
- Clean the appliance with a moist cloth. Use only neutral detergents. Do not use abrasive products, abrasive cleaning pads, solvents or metal objects.

## 2. SAFETY INSTRUCTIONS

### 2.1 Installation



The installation must comply with relevant national regulations.

- Remove all the packaging and the transit bolts including rubber bush with plastic spacer.
- Keep the transit bolts in a safe place. If the appliance is to be moved in the future they must be reattached to lock the drum to prevent an internal damage.
- Always take care when moving the appliance as it is heavy. Always use safety gloves and enclosed footwear.
- Follow the installation instructions supplied with the appliance.
- Do not install or use a damaged appliance.
- Do not install or use the appliance where the temperature can be less than 0°C or where it is exposed to the weather.
- The floor area on which the appliance is to be installed must be flat, stable, heat resistant and clean.

- Make sure that there is air circulation between the appliance and the floor.
- When the appliance is in its permanent position, check if it is levelled correctly with the aid of a spirit level. If it is not, adjust the feet accordingly.
- Do not install the appliance directly above a floor drain.
- Do not spray water on the appliance and do not expose it to excessive humidity.
- Do not install the appliance where the appliance door cannot be fully opened.
- Do not put a closed container to collect possible water leakage under the appliance. Contact the Authorised Service Centre to ensure which accessories can be used.

### 2.2 Electrical connection

#### **WARNING!**

Risk of fire and electric shock.

- **WARNING:** This appliance is designed to be installed / connected to a grounding connection in the building.

- Always use a correctly installed shockproof socket.
- Make sure that the parameters on the rating plate are compatible with the electrical ratings of the mains power supply.
- Do not use multi-plug adapters and extension cables.
- Make sure not to cause damage to the mains plug and to the mains cable. Should the mains cable need to be replaced, this must be carried out by our Authorised Service Centre.
- Connect the mains plug to the mains socket only at the end of the installation. Make sure that there is access to the mains plug after the installation.
- Do not touch the mains cable or the mains plug with wet hands.
- Do not pull the mains cable to disconnect the appliance. Always pull the mains plug.

### 2.3 Water connection

- The inlet water shall not exceed 25 °C.
- Do not cause damage to the water hoses.
- Before connection to new pipes, pipes not used for a long time, where repair work has been carried out or new devices fitted (water meters, etc.), let the water flow until it is clean and clear.
- Ensure that there are no visible water leaks during and after the first use of the appliance.
- Do not use an extension hose if the inlet hose is too short. Contact the Authorised Service Centre for the replacement of the inlet hose.
- When unpacking the appliance, It is possible to see water flowing from the drain hose. This is due to the testing of the appliance with the use of water in the factory.
- You can extend the drain hose to maximum 400 cm. Contact the Authorised Service Centre for the other drain hose and the extension.
- Make sure that there is access to the tap after the installation.

### 2.4 Use

#### **WARNING!**

Risk of injury, electric shock, fire, burns or damage to the appliance.

- Follow the safety instructions on the detergent packaging.
- Do not put flammable products or items that are wet with flammable products in, near or on the appliance.
- Do not wash fabrics which are heavily soiled with oil, grease or other greasy substances. It can damage rubber parts of the washing machine. Prewash such fabrics by hand before loading them into the washing machine.
- Do not touch the glass door while a programme operates. The glass can get hot.
- Make sure that all metal objects are removed from the laundry.

### 2.5 Service

- To repair the appliance contact the Authorised Service Centre. Use original spare parts only.
- Please note that self-repair or non-professional repair can have safety consequences and might void the guarantee.
- The following spare parts are available for at least 10 years after the model has been discontinued: motor and motor brushes, transmission between motor and drum, pumps, shock absorbers and springs, washing drum, drum spider and related ball bearings, heaters and heating elements, including heat pumps, piping and related equipment including hoses, valves, filters and aquastops, printed circuit boards, electronic displays, pressure switches, thermostats and sensors, software and firmware including reset software, door, door hinge and seals, other seals, door locking assembly, plastic peripherals such as detergent dispensers. The duration may be longer in your country. For further information, please visit our website.
- Please note that some of these spare parts are only available to professional

repairers, and that not all spare parts are relevant for all models.

- Concerning the lamp(s) inside this product and spare part lamps sold separately: These lamps are intended to withstand extreme physical conditions in household appliances, such as temperature, vibration, humidity, or are intended to signal information about the operational status of the appliance. They are not intended to be used in other applications and are not suitable for household room illumination.

## 2.6 Disposal

**⚠ WARNING!**

Risk of injury or suffocation.

- Disconnect the appliance from the mains electrical and water supplies.
- Cut off the mains electrical cable close to the appliance and dispose of it.
- Remove the door catch to prevent children or pets from becoming trapped in the drum.
- Dispose of the appliance in accordance with local requirements for the disposal of Waste Electrical and Electronic Equipment (WEEE).

## 3. PRODUCT DESCRIPTION

### 3.1 Appliance overview

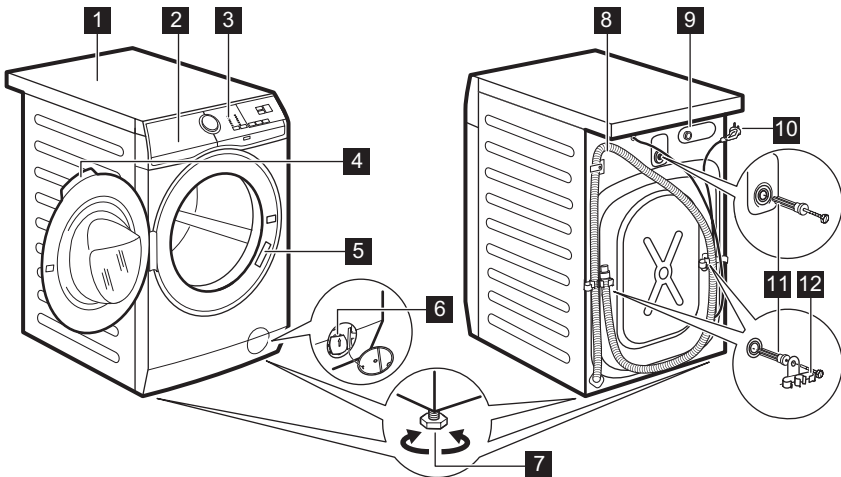

- |                              |   |
|------------------------------|---|
| <b>1</b> Worktop             | <b>7</b> Feet for levelling the appliance |
| <b>2</b> Detergent dispenser | <b>8</b> Drain hose                       |
| <b>3</b> Control panel       | <b>9</b> Inlet hose connection            |
| <b>4</b> Door handle         | <b>10</b> Mains cable                     |
| <b>5</b> Rating plate        | <b>11</b> Transit bolts                   |
| <b>6</b> Drain pump filter   | <b>12</b> Hose support                    |

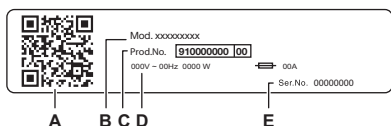

**The rating plate reports:**

- A. QR code
- B. Model name
- C. Product number
- D. Electrical ratings
- E. Serial number

Scan the **QR code** on the appliance to register your product and get the most out of it.

- - Access your appliance details, documentation and articles on how to use the best features (User Manual also available at [electrolux.com/manuals](http://electrolux.com/manuals) )
- - Get usage advice, troubleshooting, service and repair information (also available at [electrolux.com/support](http://electrolux.com/support) )
- - Buy accessories, Consumable and Original Spare parts for you appliance (also available at [electrolux.com/shop](http://electrolux.com/shop) )

## 4. TECHNICAL DATA

Dimension	Width/ Height/ Total depth	59,7 cm /84,7 cm /65,8 cm
Electrical connection	Voltage Overall power Fuse Frequency	230 V 2100 W 10 A 50 Hz
Level of protection against ingress of solid particles and moisture ensured by the protective cover, except where the low voltage equipment has no protection against moisture		IPX4
Water supply pressure	Minimum Maximum	0.5 bar (0.05 MPa) 10 bar (1.0 MPa)
Water supply <sup>1)</sup>		Cold water
Maximum Load	Cotton	9 kg
Spin Speed	Maximum spin speed	1351 rpm

<sup>1)</sup> Connect the water inlet hose to a water tap with a 3/4" thread.

## 5. INSTALLATION

**WARNING!**

Refer to Safety chapters.

## 5.1 Unpacking

1. Open the door. Remove all the items from the drum.

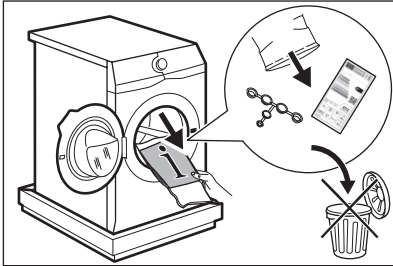

Accessories delivered with the appliance may vary depending on the model.

2. Put the packaging element on the floor behind the appliance and carefully put it down onto its rear side. Remove the polystyrene protection from the bottom.

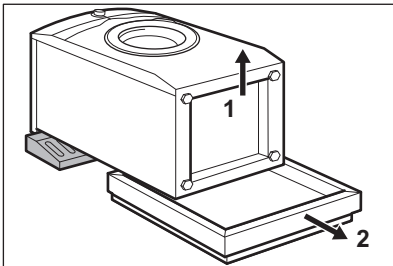

### CAUTION!

Do not lay washing machine on its front.

3. Put the appliance back into an upright position. Remove the power supply cable and the drain hose from the hose holders.

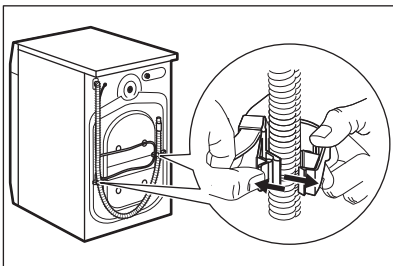

### WARNING!

It is possible to see water flowing from the drain hose. This is because the washing machine has been tested at the factory.

4. Remove the three transit bolts and pull out the plastic spacers.

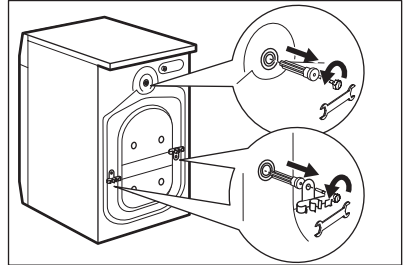

We recommend that you keep the packaging and the transit bolts for any transport of the appliance.

5. Put the plastic caps, that you find in the user manual bag, in the holes.

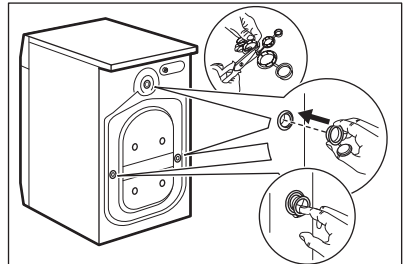

## 5.2 Information for installation

### Positioning and levelling

Adjust the appliance correctly to prevent vibration, noise and movement of the appliance when it operates.

1. Install the appliance on a flat hard floor. The appliance must be levelled and stable. Make sure that the appliance does not touch the wall or other units and there is air circulation below the appliance.
2. Loosen or tighten the feet to adjust the level. All feet must rest firmly on the floor.



**⚠ WARNING!**

Do not put cardboard, wood or equivalent materials below the appliance feet to adjust the level.

**The inlet hose**

**⚠ CAUTION!**

Make sure there is no damage to hoses and there are no leaks from the couplings. Do not use an extension hose if the inlet hose is too short. Contact the service centre for information on inlet hose replacement.

1. Connect the water inlet hose to the back of the appliance if needs. Usually, it is already installed at the factory.

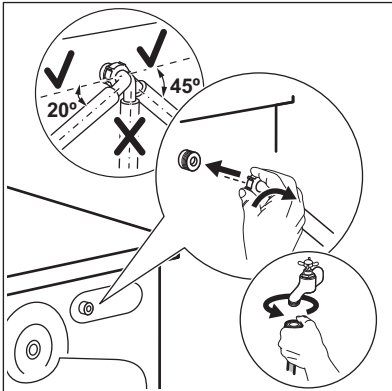

2. Position it toward left or right depending on the position of the water tap. Make sure that the inlet hose is not in vertical position.
3. If necessary, loosen the ring nut to set it in the correct position.
4. Connect the water inlet hose to the cold water tap with 3/4" thread.
5. Some models can contain inlet hose with water stop device. It prevents any leaks in the hose because of its natural ageing. The sector in the window shows this fault **A**. If this occurs, close the water tap and contact the authorized service centre for information to replace the hose.

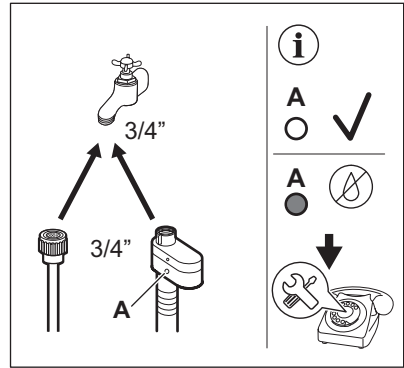

**⚠ WARNING!**

The inlet water shall not exceed 25 °C.

**Water drainage**

The drain hose should stay at a height of no less than 60 cm and not more than 100 cm.

**i**

You can extend the drain hose to maximum 400 cm. Contact the authorised service centre to buy the other drain hose and the extension.

Make sure that the drain hose makes a loop to prevent particles going into the appliance from the sink.

Connect the drain hose to the spigot and tighten it with a clamp. Make sure that the drain hose makes a loop to prevent particles going into the appliance from the sink.

Position the hose directly to a built-in drain pipe in the room wall and tighten it with a clamp.

Without the plastic hose guide, to a sink spigot- Put the drain hose in the spigot and tighten it with a clamp.

The drain hose can be bent into U shape and put around the plastic guide. On the edge of a sink - Fasten the guide to the water tap or to the wall.



Make sure that the plastic guide cannot move when the appliance drains and the drain hose end is not immersed in the water. There may be a return of dirty water into the appliance. Buy accessories from authorised supplier.

To a stand pipe with vent hole - Insert the drain hose directly into a drain pipe or stand pipe



The end of the drain hose must always be ventilated, i.e. the inner diameter of the drain pipe (min. 38 mm - min. 1.5") must be larger than the external diameter of the drain hose.

It is possible to connect the drain hose in different ways:

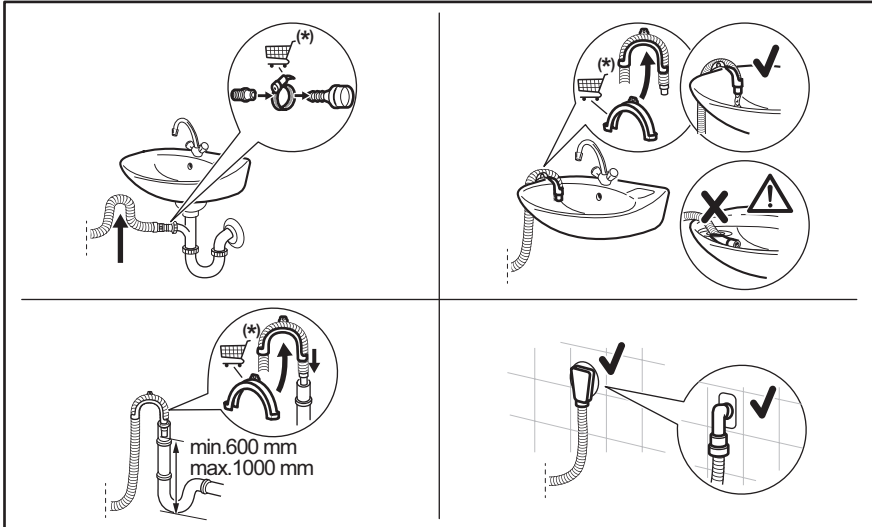

(\*) Subject to change without notice.

### 5.3 Electrical connection

At the end of installation you can connect the mains plug to the mains socket.

The rating plate and the 'Technical Data' chapter indicate the necessary electrical ratings. Make sure that they are compatible with the mains power supply.

Check that your domestic electrical installation can take the maximum load required, also taking into account any other appliances may also be in use.

### Connect the appliance to an earthed socket.

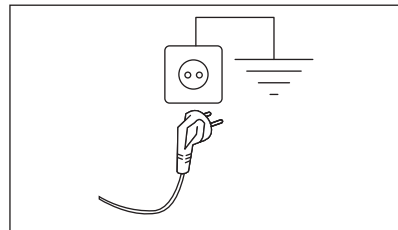

The power supply cable must be easily accessible after installing the appliance.

For any electrical work required to install this appliance, contact our Authorised Service Centre.

The manufacturer does not accept any responsibility for damage or injury through

failure to comply with the above safety precaution.

## 6. ACCESSORIES

### 6.1 Available in [www.electrolux.com/shop](http://www.electrolux.com/shop) or from authorised dealer

Read carefully the instructions supplied with the accessory.



Only appropriate accessories approved by ELECTROLUX ensure the safety standards of the appliance. If unapproved parts are used, any claims will be invalidated.

### 6.2 Fixing plate kit

If you install the appliance on a plinth that is not an accessory supplied by ELECTROLUX, secure the appliance in the fixing plates.

Read carefully the instructions supplied with the accessory.

### 6.3 Stacking kit

The tumble dryer can be stacked on the top of the washing machine **only by using the correct stacking kit**.

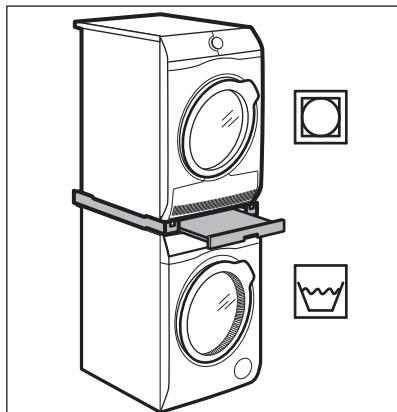

### WARNING!

Do not put the tumble dryer under the washing machine. Verify the compatible stacking kit by checking the depth of your appliances.

### 6.4 Pedestal with the drawer

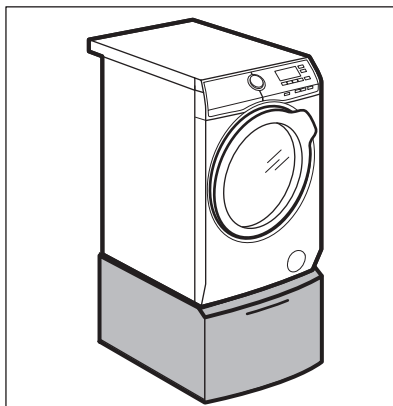

To raise your appliance and make loading and unloading laundry easier. The drawer can be used for laundry storage e.g.: towels, cleaning products and more.

## 7. CONTROL PANEL

### 7.1 Special features

Your new washing machine meets all modern requirements for an effective treatment of laundry with low water, energy and detergent consumption and will care for fabrics.



- The **SensiCare System** detects the laundry load weight defining the programme duration in 30 seconds. The washing programme is tailored to the laundry load and the type of fabric without consuming more water, energy and water than necessary. Read the paragraph "The SensiCare load detection " for more details.

- The **UniversalDose drawer** with a compartment dedicated to each type of detergent, including a compartment for PODS®, equipped with a system able to spread and mixing the detergent in an optimal way, and to dissolve the detergent residues after each cycle.
- Thanks to the Soft plus the fabric softener is uniformly spread out in the laundry and deeply penetrates the fabric fibres favouring a perfect softness.

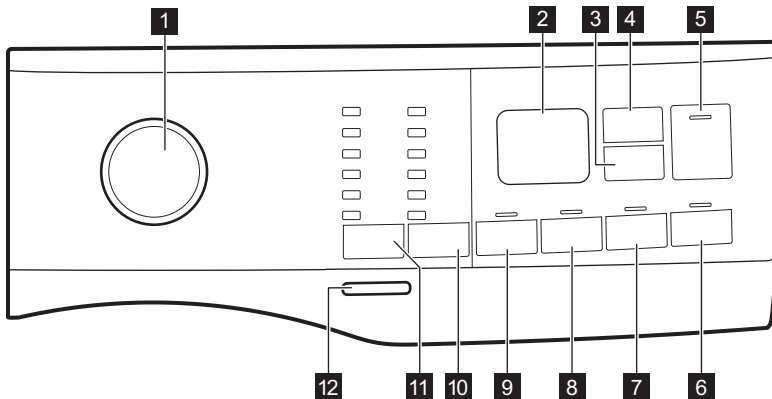
### 7.2 Control panel description



- 1** Programme dial
- 2** Display
- 3** Départ Différé touch button
- 4** Time Manager touch button
- 5** Départ/Pause touch button 
- 6** Pods® touch button
- 7** Taches touch button
- 8** Rinçage Plus touch button
- 9** Prélavage touch button
- 10** Essorage reduction options touch button

- No Spin option 
- Rinse Hold option 
- Nuit option 
- 11** Temp. touch button
- 12** Marche/Arrêt push button

## 7.3 Display

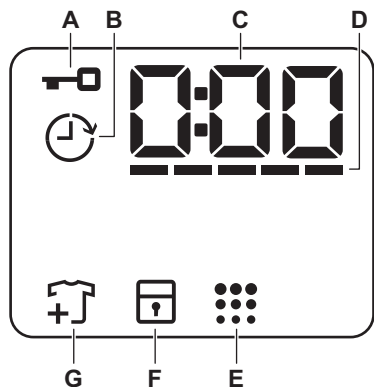

- A. : Door locked indicator  
 B. : Delay start indicator  
 C. The digital indicator can show:

- Programme duration (e. g. 2:40),
- Delay time (e. g. 2h),
- Cycle end (0:00)
- Warning code (e.g. E20).
- Indication of total operating hours of the appliance. Refer to the 'Operating hours counter' section in the 'Settings' paragraph for more details.

- D. : Time Manager bars level indicator.  
 E. : Drum clean indicator. Refer to the "Cleaning the drum" section in the "Care and cleaning" paragraph for more details.  
 F. : The indicator of the child lock  
 G. : Add garments indicator. Lights on during the beginning of the Wash phase, while the user can still pause the appliance and add more laundry.

## 8. DIAL AND BUTTONS

### 8.1 Introduction



The options/functions are not available with all washing programmes. Check the compatibility between options/functions and washing programmes in the "Programme Chart". An option/function can exclude another one, in this case the appliance doesn't allow you to set incompatible options/functions.

### 8.2 Marche/Arrêt

Press this button for a few seconds to activate or deactivate the appliance. Two different tunes sound while switching the appliance on or off.

As the Stand-by function automatically deactivates the appliance after several minutes to reduce the energy consumption, you may need to activate the appliance again.

For more details, refer to Stand-by paragraph in Daily Use chapter.

### 8.3 Temp.

When you select a washing programme, the appliance automatically proposes a default temperature.

The indicator Cold = cold water.

The indicator of the set temperature comes on.

### 8.4 Essorage

When you set a programme, the appliance automatically sets the default spin speed.

#### Additional spin options:

- **No Spin** . The related indicator comes on.  
Set this option to deactivate all spin phases. The appliance performs only the draining phase of the selected washing programme. Set this option for very delicate fabrics. The rinse phase uses more water for some washing programmes
- **Rinse Hold** . The related indicator comes on.

The final spin is not performed. The water of the last rinse is not drained out to prevent the fabrics from creasing. The washing programme ends with water in the drum.

The door stays locked and the drum turns regularly to reduce creasing. You must drain the water to unlock the door.

If you touch the **Départ/Pause**  button, the appliance performs the spinning phase and drains the water.

- **Nuit**  . The related indicator comes on. The intermediate and the final spinning phases are suppressed and the programme ends with water in the drum. This helps to reduce creasing. The door stays locked. The drum turns regularly to reduce creasing. You must drain the water to unlock the door.

As the programme is very quiet, it is suitable for use at night time when cheaper electricity tariffs are available. In some programmes the rinses are performed with more water.

If you touch the **Départ/Pause**  button, the appliance performs only the draining phase.



The appliance empties the water out automatically after approximately 18 hours.

## 8.5 Prélavage

With this option you can add a prewash phase to a washing programme.

The relevant indicator illuminates.

- Use this option to add a pre-wash phase at 30 °C before the washing phase. This option is recommended for heavily soiled laundry, especially if containing sand, dust, mud and other solid particles.



These options can increase the programme duration.

## 8.6 Permanent Rinçage Plus

With this option you can add a few rinses according to the selected washing programme.

Use this option for people with allergies to detergent residues and with sensitive skin.



This option increases the programme duration.

The corresponding indicator above the touch button illuminates and also stays permanently on during next cycles until this option is deactivated.

## 8.7 Taches

Touch this button to add the stain phase to a programme.

The corresponding indicator above the touch button illuminates.

Use this option for laundry with hard stains to remove.

When you set this option, put the stain remover into compartment .



This option increases the programme duration.  
This option is not available with a temperature lower than 40 °C.

## 8.8 Pods®

Touch this button to activate or deactivate the Pods® option .

When activated the relevant indicator is on.

Follow the Pods manufacturer's dosage and storage recommendations.

Put maximum two tablets or single-dose detergents in the Pods® compartment in the detergent dispenser drawer.

The option remains active also for next cycles until it is deactivated and if it is selectable with the set programme.

## 8.9 Time Manager

With this option you can reduce the programme duration depending on the load size and the degree of soiling.

When you set a washing programme, the display shows the default duration and ----- dashes.

Time Manager- touch button to reduce the programme duration according to your needs. The display shows the new programme duration and a number of dashes will decrease accordingly:

----- suitable for a full load of normally soiled garments.

----- a quick cycle for a full load of lightly soiled garments.

----- very quick cycle for a smaller lightly soiled load (max. half load recommended).

----- the shortest cycle to freshen up a small amount of laundry.

This option is available to programmes in the table.

indicator	Coton	Synthétiques
----- 1)	■	■
-----	■	■
-----	■	■

indicator	Coton	Synthétiques
-- 2)	■	■
- 2)	■	■



In some appliances the programme duration is reduced without showing any dashes.

1) Default duration for all programmes.

2) This level of Time Manager option is not available in 90°C.

## 8.10 Départ Différé

With this option you can delay the start of a programme to a more convenient time.

Touch the button repeatedly to set the required delay. The time increases in steps of 1 hour up to 20 hours.

The display shows the indicator and the selected delay time. After touching the Départ/Pause button, the appliance begins the countdown and the door is locked.

## 8.11 Départ/Pause





Touch the button to start, pause the appliance or interrupt a running programme.

## 9. PROGRAMMES

### 9.1 Programme Chart

Programme Default temperature Temperature range	Reference spin speed Spin speed range (rpm)	Maximum load	Programme description (Type of load and level of soiling)
<b>Washing programmes</b>			
Coton 40 °C 90 °C - Cold	1400 rpm (1400 - 800)	9 kg	White and coloured cotton fabrics. Ideal for normal and heavy soil.
Synthétiques 30 °C 60 °C - Cold	1200 rpm (1200 - 800)	4 kg	Synthetic items or mixed fabric items. Normal soil.
Délicats 30 °C 40 °C - Cold	800 rpm (1200 - 800)	2 kg	Delicate fabrics such as acrylics, viscose and mixed fabrics requiring gentler washing. Normal soil.
Laine  40 °C 40 °C - Cold	1200 rpm (1200 - 800)	1,5 kg	Machine washable wool, hand washable wool and other fabrics with «hand washing» care symbol <sup>1)</sup> .
Rapide 20 min. 30 °C 40°C-30°C	1200 rpm (1400 - 800)	3 kg	Cotton and synthetic items lightly soiled or worn only once.
Rinçage	1400 rpm (1400 - 800)	9 kg	All fabrics, except woollens and very delicate fabrics. Programme for rinsing and spinning the laundry. The default spin speed is the one used for cotton programmes. Reduce the spin speed accordingly to the type of laundry. If necessary, set the Extra Rinse option to add rinses. With a low spin speed the appliance performs delicate rinses and a short spin.
Essorage/Vidange	1400 rpm (1400 - 800)	9 kg	To spin the laundry and to drain the water in the drum. All fabrics, except woollens and delicate fabrics.
Jeans 30 °C 40 °C - Cold	800 rpm (1200 - 800)	4 kg	Special programme for Denim clothing with delicate washing phase to minimize colour fading and marks. For better care a reduced load size is recommended.
Sport 30 °C 40 °C - Cold	1200 rpm (1200 - 800)	4 kg	Synthetic sport items. This programme is designed to gently wash modern outdoor sportswear and is also suitable for gym, cycling or jogging clothes or similar.
Soie 30 °C	800 rpm (800 - 800)	0,5 kg	Machine and hand washable silk and other delicate fabrics. Drum movements are so gentle that is possible to treat even very delicate garments. Run a complete wash and dry cycle to reduce creases.



Programme Default temper- ature Temperature range	Reference spin speed Spin speed range (rpm)	Maxi- mum load	Programme description (Type of load and level of soiling)
Duvet 30 °C 60 °C - Cold	800 rpm (800 - 800)	3 kg	Special programme for synthetic or feather and down filled blanket, duvet, bedspread and so on. Use liquid delicate detergent, like wool detergent.
Outdoor  30 °C 40 °C - Cold	1200 rpm (1200 - 800)	2,5 kg <sup>2)</sup> 1 kg <sup>3)</sup>	<p>Do not use fabric softener and make sure that there is no softener residue in the detergent dispenser.</p> <p><b>Outdoor clothing, technical, sport fabrics, waterproof and breathable jackets, shell jackets with a removable fleece or inner insulation.</b> The recommended laundry load is 2,5 kg. This programme can also be used as water-repellent restoring cycle, specifically tailored for treating clothes with a hydrophobic coating. To perform the water-repellent restoring cycle, proceed as follows:</p> <ul style="list-style-type: none"> <li>• Pour the washing detergent in the compartment .</li> <li>• Pour a special water-repellent restorer for fabric in the drawer compartment for fabric softener .</li> <li>• Reduce the laundry load to 1 kg.</li> </ul> <p>To further improve the water repellency restoring action, dry the laundry in a tumble dryer by setting the Outdoor drying programme (if available and if the garment care label permits tumble drying).</p>
Hygiène  60 °C	1400 rpm (1400 - 800)	9 kg	<p><b>White cotton items.</b> This high-performance wash program combined with steam vapour, removes more than 99,99% of bacteria and viruses<sup>4)</sup> keeping the temperature above 60°C throughout the washing phase; with an additional action on the fibers thanks to a vapour phase, an enhanced rinsing phase ensures a proper removal of detergent and micro-organism residues. This program ensures also a proper reduction of pollens/allergenic items.</p>

Programme Default temper- ature Temperature range	Reference spin speed Spin speed range (rpm)	Maxi- mum load	Programme description (Type of load and level of soiling)
Eco 40-60 40 °C <b>5)</b>	1400 rpm (1400 - 800)	9 kg	White cotton and fast-coloured cotton. Normally soiled items. The energy consumption decreases and the time of the washing programme is extended, ensuring good washing results.

1) During this cycle the drum rotates slowly to ensure a gentle wash. It can seem that the drum doesn't rotate or doesn't rotate properly, but this is normal for this programme.

2) Washing programme.

3) Washing programme and waterproofing phase.

4) Tested for Staphylococcus aureus, Enterococcus faecium, Candida albicans, Pseudomonas aeruginosa and MS2 Bacteriophage in external test performed by Swisstest Testmaterialien AG in 2021 (Test Report No. 202120117).





5) According to Commission Regulation EU 2019/2023, this programme at 40 °C is able to clean normally soiled cotton laundry declared to be washable at 40 °C or 60 °C, together in the same cycle.







For the reached temperature in the laundry, the programme duration and other data, please refer to 'Consumption Values' chapter.

The most efficient programmes in terms of energy consumption are generally those that perform at lower temperatures and longer duration.

## Programme options compatibility



Programme	Essorage				Prélavage	Rinçage Plus	Taches <sup>1)</sup>	Départ Différé	Time Manager	Pods®
Coton	■	■	■	■	■	■	■	■	■	■
Synthétiques	■	■	■	■	■	■	■	■	■	■
Délicats	■	■	■	■		■		■		■
Laine 	■	■	■					■		
Rapide 20 min.	■	■						■		■
Rinçage	■	■	■			■		■		
Essorage/Vidange	■	■ <sup>2)</sup>						■		
Jeans	■	■	■	■		■	■	■		■

Programme	Essorage				Pré lavage	Rinçage Plus	Taches 1)	Départ Différé	Time Manager	Pods®
Sport	■	■	■		■	■		■		■
Soie		■						■		
Duvet		■						■		
Outdoor 	■	■	■			■		■		■
Hygiène 	■	■	■			■	■	■		■
Eco 40-60	■		■					■		■

1) This option is not available with temperature lower than 40 °C.

2) If you set the No Spin option, the appliance performs draining only.

### Suitable detergents for washing programmes

Programme	Universal powder 1)	Liquid Universal	Liquid for colours	Delicates woolens	Special
Coton	▲	▲	▲	--	--
Synthétiques	▲	▲	▲	--	--
Déliçats	--	--	--	▲	▲
Laine 	--	--	--	▲	▲
Rapide 20 min.	--	▲	▲	--	--
Jeans	--	--	▲	▲	▲
Sport	--	▲	▲	--	▲
Soie	--	--	--	▲	▲
Duvet	--	--	--	▲	▲
Outdoor 	--	--	--	▲	▲
Hygiène 	▲	▲	--	--	▲
Eco 40-60	▲	▲	▲	--	--

1) At temperature higher than 60 °C the use of powder detergent is recommended.

▲ = Recommended

-- = Not recommended

## 9.2 Woolmark Wool Care - Blue



The wool wash cycle of this machine has been approved by The Woolmark Company for the washing of wool garments labelled as «hand wash» provided that the products are washed according to the instructions on the garment label and those issued by the manufacturer of this washing machine.

M1512

The Woolmark symbol is a Certification mark in many countries.

## 10. SETTINGS

### 10.1 Acoustic signals

This appliance has different acoustic signals, that operate when:

- You activate the appliance (special short tune).
- You deactivate the appliance (special short tune).
- You touch the buttons (click sound).
- You make an invalid selection (3 short sounds).
- The programme is completed (sequence of sounds for about 1 minute).
- The appliance has a malfunction (sequence of short sounds for about 5 minutes).

To **deactivate/activate** the acoustic signals set a one of the programme, touch the Temp. and the Essorage buttons simultaneously for about 2 seconds. The display shows On/Off



If you deactivate the acoustic signals, they continue to operate when the appliance has a malfunction.

### 10.2 Child Lock

With this option you can prevent children from playing with the control panel.

To **activate/deactivate** this option, hold down the Taches button until  comes on/goes off on the display.

The appliance will default to this option after you switch it off.

The Child Lock function may not be available for a few seconds after switching the appliance on.

### 10.3 Operating Hours Counter

It is possible to visualise the total operating time of the appliance in hours, starting from the first switching on. This value will count operating time of the cycles (does not include pauses, delayed start time). To visualise this value, proceed as follows:

1. Switch the appliance on by pressing Marche/Arrêt button.
2. Turn the programme knob to any programme (starting on 1 st position clockwise).
3. Press and hold the Essorage and Prélavage buttons for some seconds (within 10 seconds after the switching on. After these 10 seconds, the key combination activates and deactivates the acoustic signals).
4. After 3 seconds the total hours operated by the appliance are shown in the display: e.g. 1276 hours, the display shows the text Hr for 2 seconds, 12 (thousands and hundreds) for 2 seconds and 76 (tens and units).



If the procedure does not work (due to timeout, wrong programme dial position or wrong keys combination), switch the appliance off and repeat sequence from the beginning.

## 10.4 Factory Reset

This function allows to restore the factory default options. To **activate** this option follow steps below:

1. Switch the appliance on by pressing Marche/Arrêt button.
2. Turn the programme knob to any programme (starting on 1 st position clockwise).

3. Press and hold the Rinçage Plus and Taches buttons for some seconds (within 10 seconds after the switching on. After these 10 seconds, the key combination activates and deactivates the acoustic signals).
4. The display will show - - - for about 5 seconds.



If the procedure does not work (due to timeout, wrong programme dial position or wrong keys combination), switch the appliance off and repeat sequence from the beginning.

## 11. BEFORE FIRST USE

1. Make sure that the electrical power is available and the water tap is open.
2. Pour a small quantity of detergent into the compartment marked by .
3. Set and start a programme for cotton at the highest temperature without any laundry in the drum.

This removes all possible dirt from the drum and the tub.

## 12. DAILY USE



### WARNING!

Refer to Safety chapters.

### 12.1 Activating the appliance

1. Connect the mains plug to the mains socket.
2. Open the water tap.
3. Press the Marche/Arrêt button for a few seconds to activate the appliance.

A short tune sounds.

### 12.2 Loading the laundry

1. Open the appliance door.
2. Empty the pockets and unfold the items before you put them in the appliance.
3. Put the laundry in the drum, one item at a time.

Do not put too much laundry in the drum.

4. Close the door firmly.

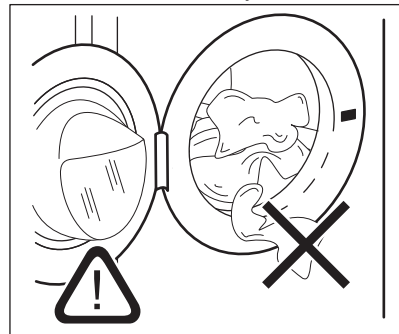

**⚠ CAUTION!**

Make sure that no laundry gets caught between the seal and the door to avoid risk of water leakage and damage to the laundry.



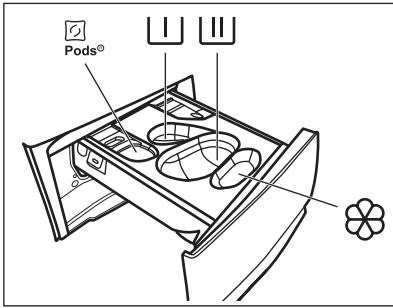

Washing heavily oiled, greasy stains could cause damage to rubber parts of the washing machine.

**12.3 Filling the detergent and additives**



 - Compartment for detergent pods (Max 2 pods). When using detergent tablets, make sure that the Pods® option is activated.

 - Compartment for prewash phase an soak programme (powder detergent only).

 - Compartment for washing phase (powder detergent only).



Make sure that the Pods® option is deactivated when using this compartment.



If using liquid detergent, remember to insert the container for liquid detergent



- Compartment for fabric softener and other liquid treatments (fabric conditioner, starch).

**MAX** - Always follow the instructions that you find on the packaging of the detergent products, but we recommend that you do not exceed the maximum indicated level (**MAX**). This quantity will however guarantee the best washing results.



After a washing cycle, if necessary, remove any detergent residue from the detergent dispenser.

Proceed as follows

1. Open the detergent dispenser.

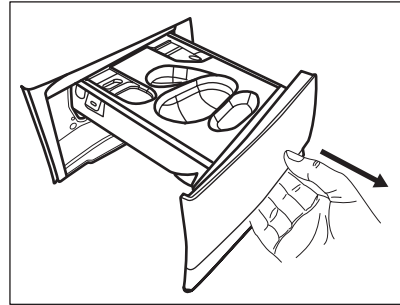

2. If a prewash phase is set, put the powder detergent in compartment .

3. For main wash, choose the proper compartment depending on the type of detergent:

a) Put the **powder detergent** in the compartment .

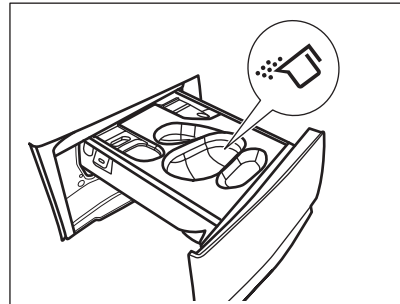

b) Pour the **liquid detergent** in the same compartment after inserting the relevant container .

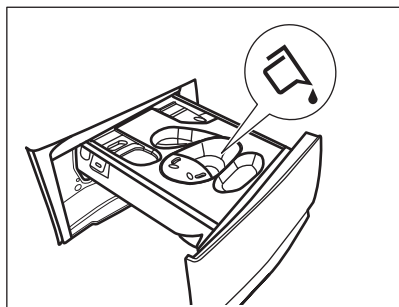
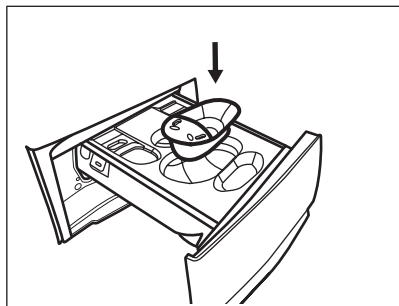

c) Put the **tablets** in the compartment . Make sure that the Pods® option is activated.

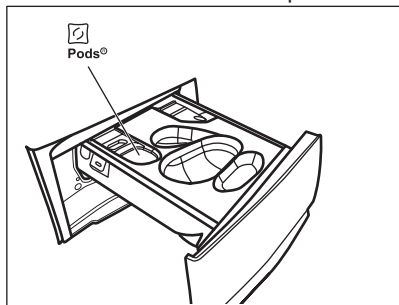

4. Pour fabric softener in the compartment .
5. Close the detergent dispenser.

## 12.4 Setting a programme

1. Turn the programme dial to select the desired washing programme.

The indicator of the Départ/Pause  button flashes.

The display shows an indicative programme duration.

2. To change the temperature and/or the spin speed, touch the related buttons.

3. If desired, set one or more options by touching the related buttons. The related indicators illuminate on the display and the given information changes accordingly.



If a selection is **not possible** an acoustic signal sounds and the display shows



---.

## 12.5 Starting a programme

1. Touch the Départ/Pause  button to start the programme. It is not possible to start the programme when the indicator of the button is off and doesn't flash (e.g. programme dial on a wrong position).

The related indicator stops flashing and stays on.



2. The programme starts, the door is locked.

The display shows the indicator  and the  symbol appears to indicate that it is still possible to stop the cycle and add garments.



The drain pump can operate shortly before the appliance fills water.

## 12.6 Starting a programme with the delay start



1. Touch the Départ Différé button repeatedly until the display shows the desired delay time.
2. Touch the Départ/Pause  button. The appliance door locks and starts the countdown of the delay start. The display shows the indicator .

When the countdown is completed, the programme starts automatically.

## labelling the delay start after the countdown has started



To cancel the delay start:

1. Touch the Départ/Pause  button to pause the appliance. The related indicator flashes.

2. Touch the Départ Différé button repeatedly until the display shows 
3. Touch the Départ/Pause  button again to start the programme immediately.

## Changing the delay start after the countdown has started

To change the delay start:

1. Touch the Départ/Pause  button to pause the appliance. The related indicator flashes.
2. Touch the Départ Différé button repeatedly until the display shows the desired delay time.
3. Touch the Départ/Pause  button again to start the new countdown.

## 12.7 The SensiCare System load detection



The programme duration in the display is referred to a **medium/high load**.

After touching the Départ/Pause  button, the SensiCare System starts the laundry load detection:

After touching the Départ/Pause button, the SensiCare System starts the laundry load detection:

1. The appliance detects the load in the first 30 seconds. In the programmes where Time Manager is available, during this phase the Time Manager bars  placed below the time digits play a simple animation. The drum rotates shortly.
2. The programme duration could be adjusted accordingly and could increase or decrease. After further 30 seconds, the water filling starts.



About 20 minutes after the programme start, the programme duration could be adjusted again depending on the capacity of water absorption of the fabrics.





The SensiCare detection is carried out with complete washing programmes only and if the programme duration has not been reduced.



The SensiCare System is not available with all programmes such as :Laine, Rinçage, Essorage and programmes with short cycles.

## 12.8 Interrupting a programme and changing the options

When the programme is running, you can change **only some** options:

1. Touch the  button. The related indicator flashes.
2. Change the options. The given information in the display changes accordingly.
3. Touch the button  again. The washing programme continues.

## 12.9 Cancelling a running programme

1. Press the Marche/Arrêt button to cancel the programme and to deactivate the appliance.
2. Press the Marche/Arrêt button again to activate the appliance.

Now, you can set a new washing programme.



If the SensiCare phase is already carried out and the water filling is already started, the new programme starts **without repeating the SensiCare phase**. The water and the detergent are not drained out in order to avoid waste. The display shows the maximum duration of the programme, updating it about 20 minutes after the starting of the new programme.

There is also an alternative way of cancelling:

1. Rotate the selector knob to the "Reset" position .



2. Wait for 1 second. The display shows ---  
Now, you can set a new washing programme.

## 12.10 Opening the door - Adding garments



If the  icon is on, you can always open the door.



If the temperature and level of the water in the drum are too high and/or the drum is still rotating you should not open the door.



While a programme or the delay start operates, the appliance door is locked. The display shows the indicator .

To add or to remove garments:

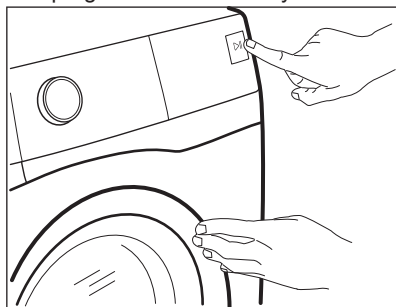
1. Touch the Départ/Pause  button. In the display the related door lock indicator goes off.
2. Open the appliance door. If necessary, add or remove the items. Close the door and touch the Départ/Pause  button. The programme or the delay start continues.



## 12.11 End of the programme

- The appliance stops automatically.
- The acoustic signals operate (if they are active).
- In the display  comes on.
- The indicator of the Départ/Pause  button goes off. The door locked  goes off and the door unlocks.

- Press the Marche/Arrêt button for some seconds to deactivate the appliance.







After some minutes from the end of the programme, the energy saving function deactivates the appliance automatically.



1. Remove the laundry from the appliance.
2. Make sure that the drum is empty.
3. Keep the door and the detergent dispenser slightly ajar to prevent mildew and odours.

## 12.12 Draining water out after end of cycle

If you have chosen a programme or an option that does not empty out the water of the last rinse, the programme is completed, but:

- The time area shows  and the display shows the door locked .
- The drum still turns at regular intervals to prevent creases in the laundry.
- The door stays locked.
- You must drain the water to open the door:

1. If necessary, touch the Essorage button to decrease the spin speed proposed by the appliance.
2. Press the Départ/Pause  button:
  - If you have set Rinse Hold  the appliance drains the water and spins.
  - If you have set Nuit  the appliance only drains the water

The option indicator Rinse Hold  and Nuit  disappears.

3. When the programme is completed and the door locked indicator  goes off, you can open the door.
4. Press the Marche/Arrêt button for a few seconds to deactivate the appliance.

## 12.13 Stand-by function

The Stand-by function automatically deactivates the appliance to reduce the energy consumption when:

- You do not use the appliance for 5 minutes when no programme is running. Press the button Marche/Arrêt to activate the appliance again.
- 5 minutes after the end of the washing programme. Press the Marche/Arrêt button to activate the appliance again. The display shows Eco 40-60 programme . You can to set now a new cycle.

If the dial is rotated to the "Reset" position , the appliance automatically turns off in 30 seconds.



If you set a programme or an option that ends with water in the drum, the Stand-by function **doesn't deactivate** the appliance to remind you to drain the water.

## 13. HINTS AND TIPS

### WARNING!

Refer to Safety chapters.

### 13.1 The laundry load

- Divide the laundry into: white, coloured, synthetics, delicates and wool.
- Follow the washing instructions on the laundry care labels.
- Do not wash white and coloured items together.
- Some coloured items can discolour with the first wash. We recommend that you wash them separately for the first couple of times.
- Turn multilayered fabrics, wool and items with printed illustrations inside out.
- Pre-treat stubborn stains.
- Wash stubborn stains with a special detergent.
- Be careful with curtains. Remove the hooks and put the curtains in a washing bag or pillowcase.
- A very small load can cause balance problems with the spin phase leading to excessive vibration. If this occurs:
  - a. interrupt the programme and open the door (refer to "Daily Use" chapter);
  - b. manually redistribute the load so that the items are spaced evenly around the tub;
  - c. press the Départ/Pause button. The spin phase continues.

- Button up pillowcases, close zippers, hooks and poppers. Tie up belts, cords, shoelaces, ribbons and any other loose elements.
- Do not wash laundry without hems or with cuts. Use a washing bag to wash small and/or delicate items (e.g. underwired bras, belts, tights, shoelaces, ribbons, etc. ).

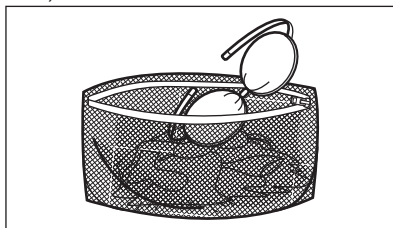

- Empty pockets and unfold the items.

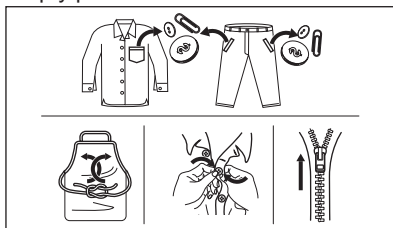

### 13.2 Stubborn stains

For some stains, water and detergent is not sufficient.

We recommend that you pre-treat these stains before you put the items in the appliance.

Special stain removers are available. Use the special stain remover that is applicable to the type of stain and fabric.

### 13.3 Detergent type and quantity

The choice of detergent and use of correct quantities not only affects your wash performance, but also helps to avoid waste and protect the environment:

- Use only detergents and other treatments specially made for washing machines. First, follow these generic rules:
  - powder detergents for all types of fabric, excluding delicate. Prefer powder detergents containing bleach for whites and laundry sanitization,
  - liquid detergents, preferably for low temperature wash programmes (60 °C max) for all types of fabric, or special ones for woollens only.
- The choice and quantity of detergent will depend on: type of fabric (delicates, woollens, cottons, etc), the colour of clothes, size of the load, degree of soiling, wash temperature and hardness of the water used.
- Follow the instructions that you find on packaging of the detergents or other treatments without exceeding the indicated maximum level (**MAX**).
- Do not mix different types of detergents.
- Use less detergent if:
  - you are washing a small load,
  - the laundry is lightly soiled,
  - there is large amounts of foam during washing.
- When using detergent tabs or pods, always put them inside the drum, not in the detergent dispenser.

**Insufficient detergent may cause:**

- unsatisfactory washing results,
- the wash load to turn grey,
- greasy clothes,
- mould in the appliance.

**Excessive detergent may cause:**

- sudsing,
- reduced washing effect,
- inadequate rinsing,
- a greater impact for the environment.

### 13.4 Ecological hints

To save water, energy and to help protect the environment, we recommend that you follow these tips:

- **Normally soiled laundry** may be washed **without prewash** in order to save detergent, water and time (the environment is protected too!).
- Loading the appliance to the **maximum capacity indicated for each programme helps to reduce energy and water consumption**.
- With adequate pre-treatment, stains and limited soiling can be removed; the laundry can then be washed at a lower temperature.
- Set the **maximum possible spin speed** for the selected washing programme **before drying your laundry in a tumble dryer**. This will save energy during drying!

### 13.5 Water hardness

If the water hardness in your area is high or moderate, we recommend that you use a water softener for washing machines. In areas where the water hardness is soft it is not necessary to use a water softener.

To find out the water hardness in your area, contact your local water authority.

Use the correct quantity of water softener. Follow the instructions that you find on the packaging of the product.

## 14. CARE AND CLEANING

### **WARNING!**

Refer to Safety chapters.

### 14.1 Periodic cleaning schedule

**Periodic cleaning helps to extend the life of your appliance.**

After each cycle, keep the door and the detergent dispenser slightly ajar to get air circulation and dry the humidity inside the appliance: this will prevent mildew and odours.

If the appliance is not used for a long time: close the water tap and unplug the appliance.

#### Indicative periodic cleaning schedule:

Descaling	Twice a year
Maintenance wash	Once a month
Clean door seal	Every two months
Clean drum	Every two months
Clean detergent dispenser	Every two months
Clean drain pump filter	Twice a year
Clean the inlet hose and the valve filter	Twice a year

The following paragraphs explain how you should clean each part.

### 14.2 Removing foreign objects



Make sure that pockets are empty and all loose elements are tied up before running your cycle. Refer to "The laundry load" in "Hints and tips".

Remove any foreign objects (such as metal clip, buttons, coins, etc) that you may find in the door seal, the filters and the drum. Refer to "Door seal with double lip trap", "Cleaning the drum", "Cleaning the drain pump" and "Cleaning the inlet hose and the valve filter" paragraphs. If necessary, please contact the Authorised Service Centre.

### 14.3 External cleaning

Clean the appliance with mild soap and warm water only. Fully dry all the surfaces. Do not use a scouring pads or any scratching material.



#### CAUTION!

Do not use alcohol, solvents or chemical products.



#### CAUTION!

Do not clean the metal surfaces with chlorine-based detergent.

### 14.4 Descaling



If the water hardness in your area is high or moderate, we recommend that you use a water descaling product for washing machines.

Regularly examine the drum to check for limescale.

Regular detergents already contain water softening agents, but we recommend to run a cycle with an empty drum and a descaling product.



Always follow the instructions that you find on the packaging of the product.

### 14.5 Maintenance wash

The repeated and prolonged use of low temperature programmes can cause detergent deposits, fluff residues, bacterial growth inside the drum and the tub. This could generate bad odours and mildew. To eliminate these deposits and clean the inner part of the appliance, run a maintenance wash regularly (at least once a month).



Refer to "Cleaning the drum" paragraph.

### 14.6 Door seal with double lip trap

This appliance is designed with a **self cleaning draining system**, allowing light fluff fibers that fall off the clothes to be drained out with the water. Regularly examine the seal. Coins, buttons, other small items can be recovered at the end of the cycle.

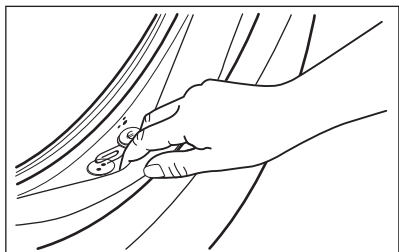

Clean it when needed, using ammonia cream cleanser agent without scratching the seal surface.



Always obey the instructions that you find on the packaging of the product.

### 14.7 Cleaning the drum

Regularly examine the drum to prevent unwanted deposits.

Rust deposits in the drum may occur due to rusting foreign body in the washing or tap water containing iron

Clean the drum with special products for stainless steel.



Always follow the instructions that you find on the packaging of the product. Do not clean the drum with acidic descaling products, scouring products containing chlorine or iron or steel wool.

For a thorough clean:

1. Remove all laundry from the drum.
2. Run a Coton programme with the highest temperature.
3. Add a small quantity of powder detergent into the empty drum, in order to rinse out any left residues.



Occasionally, at the end of a cycle the display may show the icon : this is a recommendation to perform the "drum cleaning". Once the drum cleaning has been performed, the icon disappears.

### 14.8 Cleaning the detergent dispenser

To prevent possible deposits of dried detergent, clotted fabric softener, formation of mould in the detergent dispenser, once in a while carry out the following cleaning procedure:

1. Open the detergent dispenser. Press the catch downwards as indicated in the picture and pull it out.

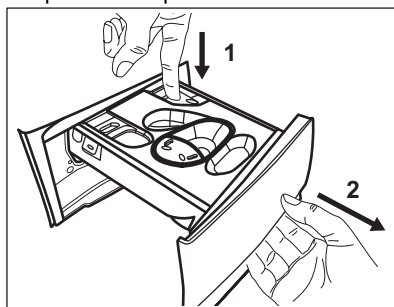

2. Remove the container for liquid detergent, if inserted.

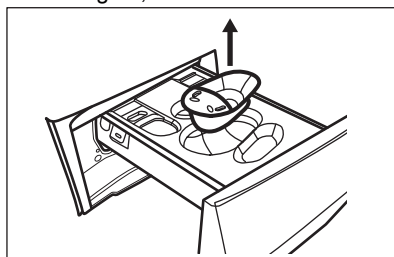

3. Lift up the top cover of the compartments to remove it.

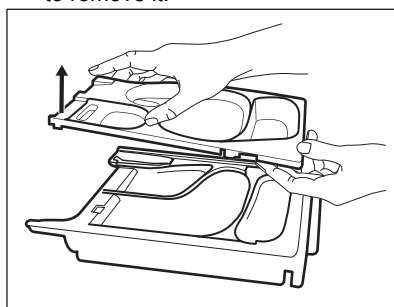

4. Wash the detergent dispenser and any insert under running water.

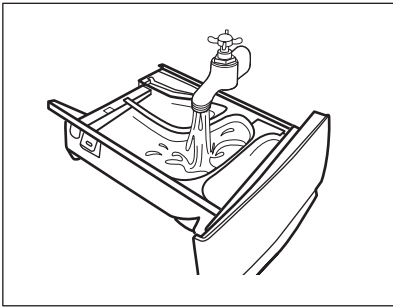

5. Make sure that all detergent residue is removed from the upper and lower part of the recess. Use a small brush to clean the recess.

**⚠ CAUTION!**

**Do not use sharp or metal brushes and sponges.**

Make sure that all detergent residue is removed from the upper and lower part of the recess. Use a small brush to clean the recess.

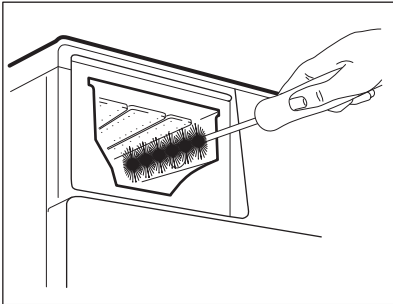

6. Turn the dispenser up side down and open the bottom cover as indicated in the picture.

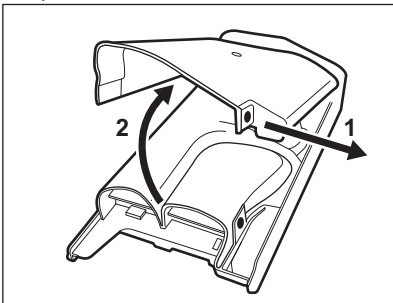

7. Make sure that all detergent residue is removed from the conveyer. Use only soft damp clothes.
8. Put bottom cover back to its position by aligning its holes on drawer hooks as indicated in the picture. Close it till "click" sound.

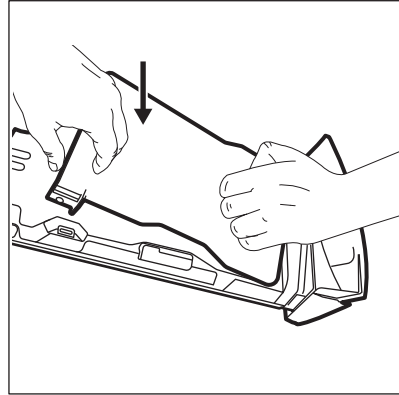

**⚠ CAUTION!**

**Press the bottom cover as indicated in the picture. Make sure that it is closed properly.**

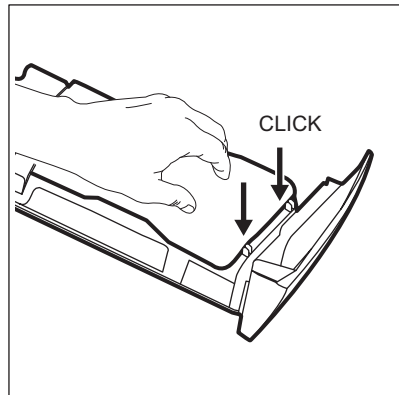

9. Reassembly the drawer as follows:
  - a. Place the bottom cover and press till "click" sound.
  - b. Place the top cover and press till "click" sound.
  - c. Insert the container for liquid detergent, if needed.
10. Insert the detergent dispenser into the guide rails and close it. Run the rinsing

programme without any clothes in the drum.

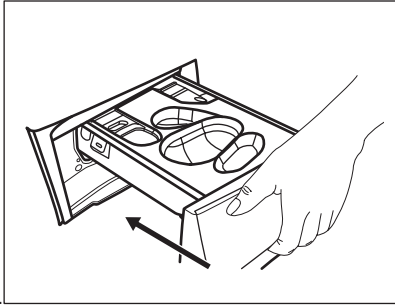

### 14.9 Cleaning the drain pump

Regularly check the drain pump filter and make sure that it is clean.

Clean the drain pump if:

- The appliance does not drain the water.

Proceed as follows to clean the pump:

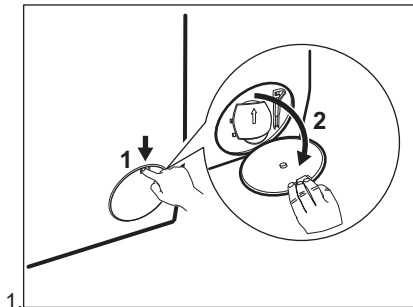

1.

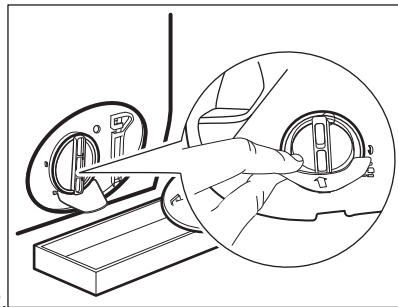

2.

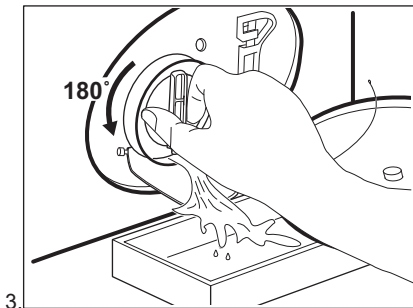

3.

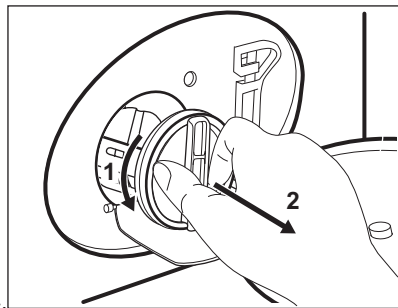

4.

- The drum does not turn.
- The appliance makes an unusual noise because of the blockage of the drain pump.
- The display shows the alarm code **E20**

#### **WARNING!**

- Disconnect the mains plug from the mains socket.
- Do not remove the filter while the appliance operates.
- Do not clean the pump if the water in the appliance is hot. Wait until the water cools down .
- Repeat Step 3 several times by closing and opening the valve until the water stops flowing out.

Always keep a rag nearby to dry up any water spillages when removing the filter.

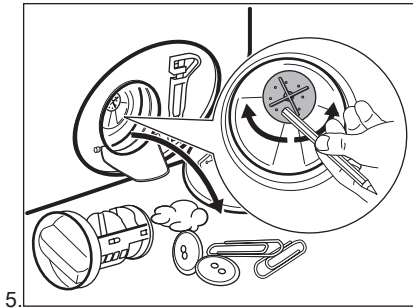

5.

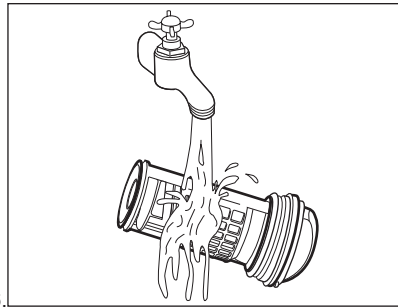

6.

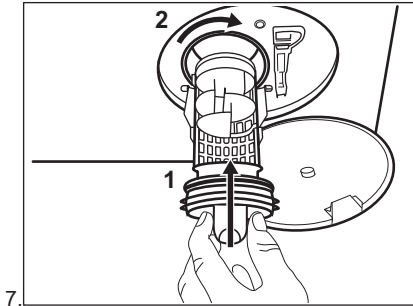

7.

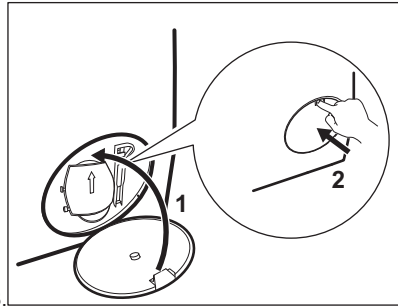

8.

**⚠ WARNING!**

Make sure that the impeller of the pump can rotate. If it does not rotate, contact the Authorised Service Centre. Make sure also that you tighten the filter correctly to prevent leakages.

### 14.10 Cleaning the inlet hose and the valve filter



It is recommended to clean both filters of the inlet hose and valve occasionally to remove any deposit collected over time.



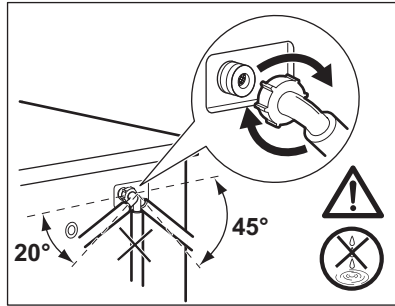
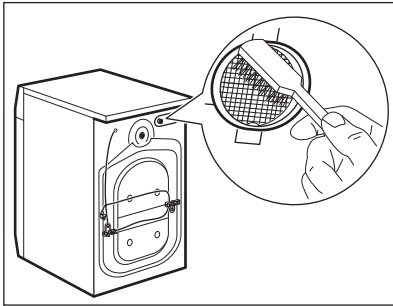
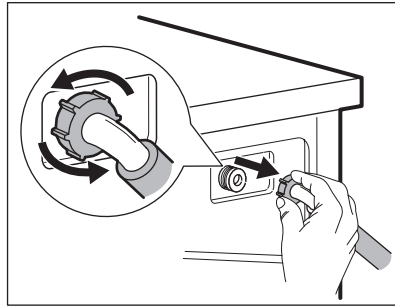
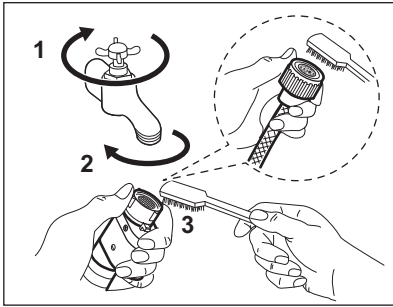

### 14.11 Emergency drain

If the appliance cannot drain the water, carry out the same procedure, described in "Cleaning the drain pump" paragraph. If necessary, clean the pump.

### 14.12 Frost precautions

If the appliance is installed in an area where the temperature can reach values around 0° C or drop below, remove the remaining water from the inlet hose and the drain pump.

1. Disconnect the mains plug from the mains socket.
2. Close the water tap.

3. Put the two ends of the inlet hose in a container and let the water flow out of the hose.
4. Empty the drain pump. Refer to the emergency drain procedure.
5. When the drain pump is empty, install the inlet hose again.

#### **WARNING!**

Make sure that the temperature is higher than 0 °C before you use the appliance again.

The manufacturer is not responsible for damages caused by low temperatures.

## 15. TROUBLESHOOTING

#### **WARNING!**

Refer to Safety chapters.

### 15.1 Alarm Codes and Potential failures

The appliance does not start or it stops during operation. First try to find a solution to the problem (refer to the tables).

 **WARNING!**

Deactivate the appliance before carrying out any check.

**With some problems, the display shows an alarm code and the Départ/Pause  button may flash continuously:**

Alarm Codes	Possible solution
<b>E 10</b> The appliance does not fill with water properly.	<ul style="list-style-type: none"><li>• Make sure that the water tap is open.</li><li>• Make sure that the pressure of the water supply is not too low. For this information, contact your local water authority.</li><li>• Make sure that the water tap is not clogged.</li><li>• Make sure that the inlet hose has no kinks, damages or bends.</li><li>• Make sure that the connection of the water inlet hose is correct.</li><li>• Make sure that the filter of the inlet hose and the filter of the valve are not clogged. Refer to "Care and cleaning".</li></ul>
<b>E20</b> The appliance does not drain the water.	<ul style="list-style-type: none"><li>• Make sure that the sink spigot is not clogged.</li><li>• Make sure that the drain hose has no kinks or bends.</li><li>• Make sure that the drain filter is not clogged. Clean the filter, if necessary. Refer to "Care and cleaning".</li><li>• Make sure that the connection of the drain hose is correct.</li><li>• Set the drain programme if you set a programme without drain phase.</li><li>• Set the drain programme if you set an option which ends with water in the tub.</li></ul>
<b>E40</b> The appliance door is open or not closed correctly.	<ul style="list-style-type: none"><li>• Make sure that the door is properly closed.</li></ul>
<b>E91</b> Internal fail. No communication between electronic elements of the appliance.	<ul style="list-style-type: none"><li>• The programme was not finished properly or the appliance stopped too early. Switch the appliance off and on again.</li><li>• If the alarm code appears again, contact the Authorised Service Centre.</li></ul>
<b>E90</b> The appliance drum doors are open or not closed correctly.	<ul style="list-style-type: none"><li>• Make sure that drum doors are properly closed.</li></ul>
<b>EKO</b> The mains supply is unstable.	<ul style="list-style-type: none"><li>• Wait until mains supply is stable.</li></ul>
<b>EFO</b> The anti-flood device is on.	<ul style="list-style-type: none"><li>• Disconnect the appliance and close the water tap. Contact the Authorised Service Centre.</li></ul>

If the display shows other alarm codes, deactivate and activate the appliance. If the problem continues, contact the Authorised Service Centre.

Some errors may not occur. Subject to change without notice.

**In case of different problem with the appliance check the table below for possible solutions.**

Potential failures	Possible solution
The programme does not start.	<ul style="list-style-type: none"> <li>• Make sure that the mains plug is connected to the mains socket.</li> <li>• Make sure that the appliance door is closed.</li> <li>• Make sure that there is no damaged fuse in the fuse box.</li> <li>• Make sure that the Départ/Pause  has been touched.</li> <li>• If the delay start is set, cancel the setting or wait for the end of countdown.</li> <li>• Deactivate the Child Lock function if it is on.</li> <li>• Check the position of the knob on the selected programme.</li> </ul>
The appliance fills with water and drains immediately.	<ul style="list-style-type: none"> <li>• Make sure that the drain hose is in the correct position. The hose may be positioned too low. Refer to "Installation instruction".</li> </ul>
The spin phase does not operate or the washing cycle lasts longer than usual.	<ul style="list-style-type: none"> <li>• Set the spin programme.</li> <li>• Make sure that the drain filter is not clogged. Clean the filter, if necessary. Refer to "Care and cleaning".</li> <li>• Adjust manually the items in the tub and start the spin phase again. This problem may be caused by balance problems.</li> </ul>
There is water on the floor.	<ul style="list-style-type: none"> <li>• Make sure that the couplings of the water hoses are tight and there is not water leakages.</li> <li>• Make sure that the water inlet hose and the drain hose have no damages.</li> <li>• Make sure you use the correct detergent and the correct quantity of it.</li> </ul>
You cannot open the appliance door.	<ul style="list-style-type: none"> <li>• Make sure that a washing programme that ends with water in tub, has not been selected.</li> <li>• Make sure that the washing programme is finished.</li> <li>• Set the drain or the spin programme if there is water in the drum.</li> <li>• Make sure that the appliance receives electrical power.</li> <li>• This problem may be caused by a failure of the appliance. Contact the Authorised Service Centre.</li> </ul>
The appliance makes an unusual noise and vibrates.	<ul style="list-style-type: none"> <li>• Make sure the levelling of the appliance is correct. Refer to "Installation instruction".</li> <li>• Make sure that the packaging and/or the transit bolts are removed. Refer to "Installation instruction".</li> <li>• Add more laundry in the drum. The load may be too small.</li> </ul>
The programme duration increases or decreases during programme execution.	<ul style="list-style-type: none"> <li>• The SensiCare System is able to adjust the programme duration according to the type and the laundry load size. Refer to "The SensiCare System load detection" in "Daily Use" chapter.</li> </ul>
The washing results are not satisfactory.	<ul style="list-style-type: none"> <li>• Increase the detergent quantity or use a different detergent.</li> <li>• Use special products to remove the stubborn stains before you wash the laundry.</li> <li>• Make sure that you set the correct temperature.</li> <li>• Decrease the laundry load.</li> </ul>
Too much foam in the drum during the washing cycle.	<ul style="list-style-type: none"> <li>• Reduce the quantity of detergent or the number of tablets or single-dose detergents.</li> </ul>

Potential failures	Possible solution
After the washing cycle, there are some detergent residues in the dispenser drawer.	<ul style="list-style-type: none"> <li>• Make sure you have used the detergent dispenser according the indications given in this user manual.</li> <li>• Make sure to use fresh tablets or single-dose detergents. Store them in their box and close it after use, according to the manufacturer's recommendations. Direct exposure to environment can modify their characteristic and their behaviour in the Pods® compartment, specially in combination with certain options (e.g. Départ Différé).</li> </ul>

After the check, activate the appliance. The programme continues from the point of interruption. If the problem occurs again, contact the Authorised Service Centre.

The necessary data for the service centre are on the rating plate.

## 16. CONSUMPTION VALUES

### 16.1 Comment



The QR code on the energy label supplied with the appliance provides a web link to the information related to the performance of the appliance in the EU EPREL database. Keep the energy label for reference together with the user manual and all other documents provided with this appliance.

It is also possible to find the same information in EPREL using the link <https://eprel.ec.europa.eu> and the model name and product number that you find on the rating plate of the appliance. Refer to 'Product description' chapter for the position of the rating plate.



Values and programme duration may differ depending on different conditions (e.g. room temperature, water temperature and pressure, load size and type of laundry, supply voltage) and also if you change the default setting of a programme.

### 16.2 According to Commission Regulation Eu 2019/2023

Eco 40-60 programme	kg	kWh	Litres	hh:mm	%	°C	rpm <sup>1)</sup>
Full load	9	0.760	64.0	3:40	53.00	33	1351
Half load	4,5	0.440	47.0	2:45	53.00	27	1351
Quarter load	2,5	0.300	39.0	2:35	54.00	26	1351

1) Maximum spin speed.

## Power consumption in different modes

Off (W)	Stand-by (W)	Delay start (W)
0.50	0.50	4.00

Time to Off/Standby mode is 15 minutes maximum.

## 16.3 Common programmes

Programme	kg	kWh	Litres	hh:mm	%	°C	rpm
Coton <sup>1)</sup> 90°C	9	2.75	85.0	4:00	52.00	85	1400
Coton 60°C	9	1.65	80.0	3:30	52.00	55	1400
Coton <sup>2)</sup> 20°C	9	0.35	80.0	3:00	52.00	20	1400
Synthétiques 40°C	4	0.85	75.0	2:30	35.00	40	1200
Déliçats <sup>3)</sup> 30°C	2	0.35	60.0	1:25	35.00	30	1200
Laine 30°C	1,5	0.30	70.0	1:05	30.00	30	1200

1) Suitable for washing heavily soiled textiles.

2) Suitable for washing lightly soiled cottons, synthetic and mixed fabrics.

3) It also performs as quick washing cycle for lightly soiled laundry.

## 17. QUICK GUIDE

### 17.1 Daily use

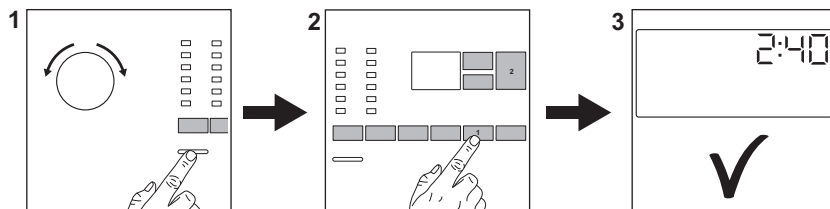

Connect the mains plug to the mains socket.

Open the water tap.

Load the laundry.

Pour the detergent and other treatment in the proper compartment of the detergent dispenser.

1. Push the **Marche/Arrêt** button to turn the appliance on. Turn the programme dial to set the desired programme.

2. Set the desired options (1) by means of the corresponding touch buttons. To start the programme, touch the button (2)**Départ/Pause** 

3. The appliance starts.  
At the end of the programme, remove the laundry.



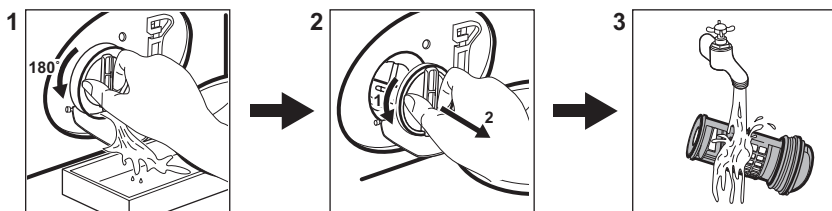

Push the **Marche/Arrêt** button to turn the appliance off.

### 17.2 Cleaning the drain pump filter



Clean the filter regularly and, especially, if the alarm code **E20** appears on the display.

### 17.3 Programmes

Programme	Load	Product description
<b>Coton</b>	9 kg	White and coloured cotton fabrics. Ideal for normal and heavy soil.
<b>Synthétiques</b>	4 kg	Synthetic items or mixed fabric items.
<b>Déliçats</b>	2 kg	Delicate fabrics such as acrylics, viscose, polyester items.
<b>Laine</b>  	1,5 kg	Machine washable wool, hand washable wool and delicates.
<b>Rapide 20 min.</b>	3 kg	Cotton and synthetic items lightly soiled or worn only once.
<b>Rinçage</b>	9 kg	All fabrics, except woollens and very delicate fabrics. Programme for rinsing and spinning.
<b>Essorage/Vidange</b>	9 kg	All fabrics, except woollens and very delicate fabrics. Programme for spinning and draining the water.
<b>Jeans</b>	4 kg	Denim clothing and jersey items.
<b>Sport</b>	4 kg	Sportswear.
<b>Soie</b>	0,5 kg	Special programme for silk and mixed synthetic items.
<b>Duvet</b>	3 kg	Single synthetic blanket, bedspread, duvet.
<b>Outdoor</b> 	2,5 kg <sup>1)</sup> 1 kg <sup>2)</sup>	Modern outdoor sporting garments.
<b>Hygiène</b>  	9 kg	White cotton items. This programme removes more than 99,99% of bacteria and viruses <sup>3)</sup>

Programme	Load	Product description
Eco 40-60	9 kg	White and coloured cottons. Normally soiled garments.

1) Washing programme.

2) Washing programme and waterproofing phase.

3) Tested for Staphylococcus aureus, Enterococcus faecium, Candida albicans, Pseudomonas aeruginosa and MS2 Bacteriophage in external test performed by Swissatest Testmaterialien AG in 2021 (Test Report No. 202120117).

## 18. ENVIRONMENTAL CONCERNS

Recycle materials with the symbol . Put the packaging in relevant containers to recycle it. Help protect the environment and human health by recycling waste of electrical and electronic appliances. Do not dispose of

appliances marked with the symbol  with the household waste. Return the product to your local recycling facility or contact your municipal office.

**electrolux.com**

135964980-A-412023



**CE**