



Electrolux



electrolux.com/register



EW7T3733BA

FR Notice d'utilisation | Lave-linge



Bienvenue chez Electrolux ! Nous vous remercions d'avoir choisi l'un de nos appareils.



Dans un souci de durabilité, nous réduisons les supports papier et proposons les manuels d'utilisation complets en ligne. Accédez à votre manuel d'utilisation complet sur electrolux.com/manuals



Obtenir des conseils d'utilisation, des brochures, des dépannages, des informations sur le service et les réparations sur electrolux.com/support



Achetez des accessoires, des consommables et des pièces de rechange d'origine pour votre appareil sur electrolux.com/shop

Sous réserve de modifications.

TABLE DES MATIÈRES

1. CONSIGNES DE SÉCURITÉ.....	2
2. CONSIGNES DE SÉCURITÉ.....	4
3. DESCRIPTION DU PRODUIT.....	7
4. CARACTÉRISTIQUES TECHNIQUES.....	8
5. BANDEAU DE COMMANDE.....	9
6. MANETTES ET TOUCHES.....	11
7. PROGRAMMES.....	14
8. CONFIGURATIONS.....	19
9. UTILISATION QUOTIDIENNE.....	20
10. ENTRETIEN ET NETTOYAGE.....	23
11. VALEURS DE CONSOMMATION.....	27
12. GUIDE D'UTILISATION RAPIDE.....	29
13. CODES D'ALARME ET DÉFAILLANCES POSSIBLES.....	32
14. CONSIDÉRATIONS ENVIRONNEMENTALES.....	33

1. ⚠ CONSIGNES DE SÉCURITÉ



Avant de commencer à installer et à utiliser cet appareil, lisez soigneusement les instructions fournies.

Le fabricant ne pourra pas être tenu responsable des blessures et dégâts résultant d'une mauvaise installation ou utilisation. Conservez toujours les instructions dans un lieu sûr et accessible pour vous y référer ultérieurement.

1.1 Sécurité des enfants et des personnes vulnérables

- Cet appareil peut être utilisé par des enfants âgés d'au moins 8 ans et par des personnes ayant des capacités

physiques, sensorielles ou mentales réduites ou dénuées d'expérience ou de connaissance, s'ils sont correctement surveillés ou si des instructions relatives à l'utilisation de l'appareil en toute sécurité leur ont été données et s'ils comprennent les risques encourus.

- Les enfants entre 3 et 8 ans et les personnes ayant un handicap très important et complexe doivent être tenus à l'écart de l'appareil, à moins d'être surveillés en permanence.
- Les enfants de moins de 3 ans doivent être tenus à l'écart de l'appareil, à moins d'être surveillés en permanence.
- Veillez à ce que les enfants ne jouent pas avec l'appareil.
- Ne laissez pas les emballages à la portée des enfants et jetez-les convenablement.
- Ne laissez pas les détergents à la portée des enfants.
- Tenez les enfants et les animaux éloignés de l'appareil lorsque la porte est ouverte.
- Si l'appareil est équipé d'un dispositif de sécurité enfants, nous vous recommandons de l'activer.
- Le nettoyage et l'entretien par l'utilisateur ne doivent pas être effectués par des enfants sans surveillance.

1.2 Sécurité générale

- Cet appareil est destiné au lavage du linge domestique, lavable en machine uniquement.
- Cet appareil est conçu pour un usage domestique ménager, dans un environnement intérieur.
- Cet appareil peut être utilisé dans les bureaux, les chambres d'hôtel, les chambres d'hôtes, les gîtes ruraux et d'autres hébergements similaires lorsque cette utilisation ne dépasse pas le niveau (moyen) de l'utilisation domestique.
- Ne modifiez pas les spécifications de cet appareil.
- La charge maximale de l'appareil est de 7 kg. Ne dépassez pas la charge maximale de chaque programme (reportez-vous au chapitre « Programmes »).

- La pression d'eau de service au point d'entrée d'eau du raccord de sortie doit être comprise entre 0,5 bar (0,05 MPa) et 10 bar (1,0 MPa).
- Les orifices d'aération situés à la base ne doivent pas être obstrués par de la moquette, un tapis, ou tout type de revêtement de sol.
- L'appareil doit être raccordé à l'arrivée d'eau à l'aide des tuyaux neufs fournis, ou d'autres tuyaux neufs fournis par le service après-vente agréé.
- Les anciens ensembles de tuyaux ne doivent pas être réutilisés.
- Si le câble d'alimentation secteur est endommagé, son remplacement doit être confié exclusivement au fabricant, à son service après-vente ou à toute autre personne qualifiée afin d'éviter tout danger électrique.
- Avant toute opération d'entretien, mettez l'appareil à l'arrêt et débranchez-le de l'alimentation électrique.
- Ne pulvérisez pas d'eau ni de vapeur à haute pression pour nettoyer l'appareil.
- Nettoyez l'appareil avec un chiffon humide. Utilisez uniquement des produits de lavage neutres. N'utilisez pas de produits abrasifs, de tampons à récurer, de solvants ou d'objets métalliques.

2. CONSIGNES DE SÉCURITÉ

2.1 Instructions d'installation



L'installation doit être conforme aux réglementations nationales en vigueur.

- Retirez l'intégralité de l'emballage et les boulons de transport, y compris le joint en caoutchouc et l'entretoise en plastique.
- Conservez les boulons de transport en lieu sûr. Si l'appareil doit être de nouveau déplacé, les boulons doivent être réutilisés pour maintenir le tambour en place et éviter tout dégât interne.
- Soyez toujours vigilants lorsque vous déplacez l'appareil car il est lourd. Utilisez toujours des gants de sécurité et des chaussures fermées.
- Suivez scrupuleusement les instructions d'installation fournies avec l'appareil.
- N'installez pas et ne branchez pas un appareil endommagé.
- N'installez pas l'appareil ou ne l'utilisez pas dans un endroit où la température ambiante est inférieure à 0 °C ou dans un endroit exposé aux intempéries.
- L'appareil doit être installé sur un sol plat, stable, résistant à la chaleur et propre.
- Assurez-vous que de l'air circule entre l'appareil et le sol.

- Une fois l'appareil installé à son emplacement permanent, vérifiez qu'il est bien de niveau à l'aide d'un niveau à bulle. S'il n'est pas de niveau, réglez les pieds jusqu'à ce qu'il le soit.
- N'installez pas l'appareil directement au-dessus d'une évacuation dans le sol.
- Ne vaporisez pas d'eau sur l'appareil et ne l'exposez pas à une humidité excessive.
- N'installez pas l'appareil dans un endroit où il ne pourrait pas être complètement ouvert.
- Ne placez aucun récipient fermé sous l'appareil pour récupérer tout éventuel écoulement. Contactez le service après-vente agréé pour connaître les accessoires disponibles.

2.2 Branchement électrique

AVERTISSEMENT!

Risque d'incendie ou d'électrocution.

- AVERTISSEMENT : Cet appareil est conçu pour être installé/connecté à une connexion de mise à la terre dans le bâtiment.
- Utilisez toujours une prise de courant de sécurité correctement installée.
- Assurez-vous que les paramètres figurant sur la plaque signalétique correspondent aux données électriques nominale de l'alimentation secteur.
- N'utilisez pas d'adaptateurs multiprise et de rallonges.
- Veillez à ne pas endommager la fiche secteur ni le câble d'alimentation. Le remplacement du câble d'alimentation de l'appareil doit être effectué par notre service après-vente agréé.
- Ne branchez la fiche secteur dans la prise secteur qu'à la fin de l'installation. Assurez-vous que la prise secteur est accessible après l'installation.
- Ne touchez jamais le câble d'alimentation ni la fiche avec des mains mouillées.
- Ne tirez pas sur le câble secteur pour débrancher l'appareil. Tirez toujours sur la fiche de la prise secteur.

2.3 Raccordement à l'arrivée d'eau

- L'arrivée d'eau ne doit pas dépasser 25 °C.

- Veillez à ne pas endommager les tuyaux de circulation d'eau.
- Avant d'installer des tuyaux neufs, des tuyaux n'ayant pas servi depuis longtemps, lorsqu'une réparation a été effectuée ou qu'un nouveau dispositif a été installé (compteurs d'eau, etc.), laissez l'eau s'écouler jusqu'à ce qu'elle soit parfaitement propre et claire.
- Pendant et après la première utilisation de l'appareil, vérifiez qu'aucune fuite n'est visible.
- N'utilisez pas de rallonge si les tuyaux d'arrivée d'eau sont trop courts. Contactez le service après-vente agréé pour remplacer le tuyau d'alimentation.
- Lors du déballage de l'appareil, il est possible de voir de l'eau s'écouler du tuyau d'évacuation. Cette eau provient des tests effectués sur l'appareil en usine.
- Vous pouvez rallonger le tuyau de vidange jusqu'à 400 cm maximum. Contactez le service après-vente agréé pour l'autre tuyau de vidange et l'extension.
- Assurez-vous que le robinet est accessible une fois l'appareil installé.
- Fermez le robinet d'arrivée d'eau après chaque utilisation de l'appareil.

2.4 Utilisation

AVERTISSEMENT!

Risque de blessure, de choc électrique, d'incendie, de brûlures ou de dommage matériel à l'appareil.

- Suivez les consignes de sécurité figurant sur l'emballage du produit de lavage.
- Ne placez pas de produits inflammables ou d'éléments imbibés de produits inflammables à l'intérieur, à proximité ou au-dessus de l'appareil.
- Ne lavez pas les textiles très tachés par de l'huile, de la graisse ou une autre substance grasse. Cela peut endommager les pièces en caoutchouc de l'appareil.
- Ne lavez pas les textiles très tachés par de l'huile, de la graisse ou une autre substance grasse. Cela peut endommager les pièces en caoutchouc de l'appareil. Prélevez de tels articles à la main avant de les introduire dans l'appareil.
- N'utilisez pas de parfums de lessive pour éviter d'endommager les pièces en plastique et en caoutchouc de l'appareil.
- Veillez à retirer tout objet métallique du linge.

2.5 Service

- Pour réparer l'appareil, contactez le service après-vente agréé. Utilisez uniquement des pièces de rechange d'origine.
- Veuillez noter qu'une autoréparation ou une réparation non professionnelle peuvent avoir des conséquences sur la sécurité et annuler la garantie.
- Les pièces de rechange suivantes sont disponibles pendant au moins 10 ans après l'arrêt du modèle : moteur et balais de moteur, transmission entre le moteur et le tambour, pompes, amortisseurs et ressorts, tambour de lavage, support de tambour et roulements à billes correspondants, résistances, dont thermopompes, canalisations et équipements correspondants dont tuyaux, valves, filtres et électrovannes (aquastops), cartes de circuits imprimés, affichages électroniques, pressostats, thermostats et capteurs, logiciel et firmware dont logiciel de réinitialisation, porte, charnière et joints de porte, autres joints, ensemble de verrouillage de porte, périphériques en plastique tels que distributeurs de détergent. La durée peut être plus longue dans certains pays. Pour plus d'informations, rendez-vous sur notre site Internet.
- Veuillez noter que certaines de ces pièces détachées ne sont disponibles qu'après

de réparateurs professionnels et que toutes les pièces détachées ne sont pas adaptées à tous les modèles.

- Concernant la/les lampe(s) à l'intérieur de ce produit et les lampes de rechange vendues séparément : Ces lampes sont conçues pour résister à des conditions physiques extrêmes dans les appareils électroménagers, telles que la température, les vibrations, l'humidité, ou sont conçues pour signaler des informations sur le statut opérationnel de l'appareil. Elles ne sont pas destinées à être utilisées dans d'autres applications et ne conviennent pas à l'éclairage des pièces d'un logement.

2.6 Mise au rebut

AVERTISSEMENT!

Risque de blessure ou d'asphyxie.

- Débranchez l'appareil de l'alimentation électrique et de l'arrivée d'eau.
- Coupez le câble d'alimentation au ras de l'appareil et mettez-le au rebut.
- Retirez le dispositif de verrouillage du hublot pour empêcher les enfants et les animaux de s'enfermer dans le tambour.
- Jetez l'appareil en vous conformant aux exigences locales relatives à la mise au rebut des Déchets d'équipements électriques et électroniques (DEEE).

3. DESCRIPTION DU PRODUIT

3.1 Vue d'ensemble de l'appareil

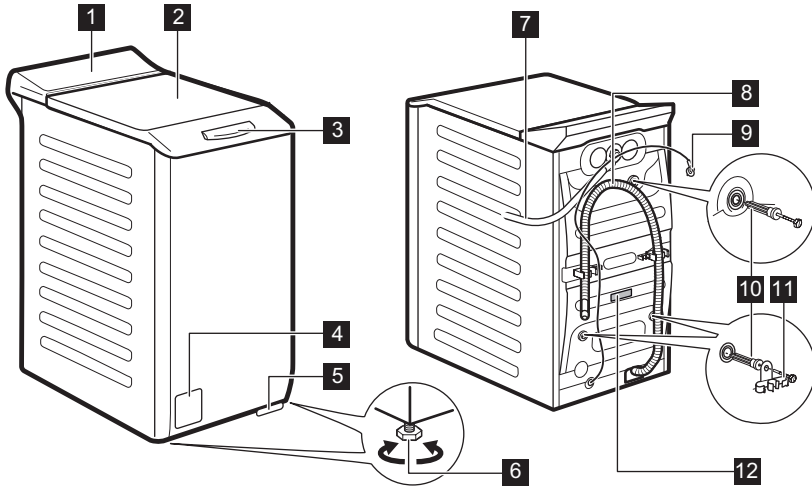

- 1** Bandeau de commande
- 2** Couvercle
- 3** Poignée d'ouverture du couvercle
- 4** Filtre de la pompe de vidange
- 5** Levier de déplacement du lave-linge
- 6** Pieds pour la mise de niveau de l'appareil
- 7** Tuyau d'arrivée d'eau

- 8** Tuyau de vidange
- 9** Câble d'alimentation électrique
- 10** Boulons de transport
- 11** Support du tuyau
- 12** Plaque signalétique

Informations pour l'enregistrement du produit.

La **plaque signalétique** indique le nom du modèle (**A**), le numéro de produit (**B**), les valeurs électriques nominales (**C**) et le numéro de série (**D**).

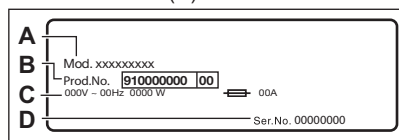

L'**étiquette d'informations** indique le nom du modèle (**A**), le numéro de produit (**B**) et le numéro de série (**C**).

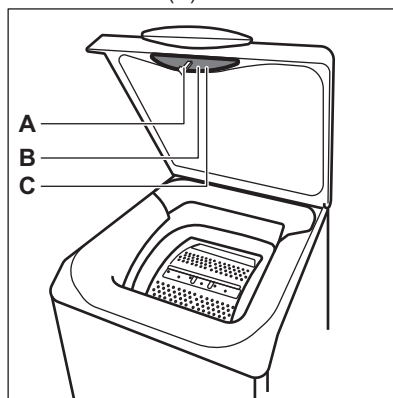

4. CARACTÉRISTIQUES TECHNIQUES

Dimensions	Largeur / Hauteur / Profondeur totale	39,7 cm / 90,8 cm / 59,9 cm
Branchement électrique	Tension	230 V
	Puissance globale	2100 W
	Fusible	10 A
	Fréquence	50 Hz
Le niveau de protection contre l'infiltration de particules solides et d'humidité est assuré par le couvercle de protection, sauf si l'équipement basse tension ne dispose d'aucune protection contre l'humidité		IPX4
Pression de l'arrivée d'eau	Minimale	0,5 bar (0,05 MPa)
	Maximale	10 bar (1,0 MPa)
Alimentation en eau ¹⁾		Eau froide
Charge maximale	Coton	7 kg

¹⁾ Raccordez le tuyau d'arrivée d'eau à un robinet d'eau muni d'un 3/4" filetage.

5. BANDEAU DE COMMANDE



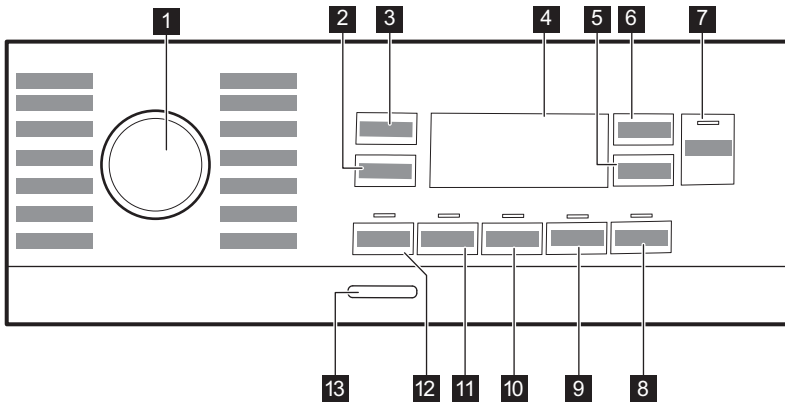





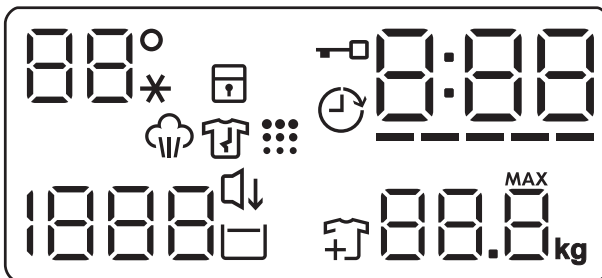





5.1 Description du bandeau de commande



- | | |
|--|--|
| 1 Sélecteur de programme | 8 Touche tactile Vapeur Plus |
| 2 Touche tactile d'options Essorage | 9 Touche tactile Douceur Plus |
| 3 Touche tactile Temp. | 10 Touche tactile Rinçage Plus |
| 4 Affichage | 11 Touche tactile Taches |
| 5 Touche tactile Départ Différé | 12 Touche tactile Prélavage |
| 6 Touche tactile Time Manager | 13 Appuyez sur la touche Marche/Arrêt |
| 7 Touche tactile Départ/Pause ▶ | |

5.2 Affichage



	La zone Température : Indicateur de température Voyant d'eau froide
	Voyant Sécurité enfants.
	Voyant Départ différé.
	Voyant Couvercle verrouillé.
	L'indicateur digital peut afficher : <ul style="list-style-type: none"> • Durée du programme (par ex. 2:40). • Départ différé (par ex. 2h). • Fin du cycle (0:00). • Code d'alarme (par ex. E20). • Indication des heures de fonctionnement totales de l'appareil. Pour plus de détails, reportez-vous au chapitre « Compteur d'heures de fonctionnement » du paragraphe « Réglages ».
	Indicateur à barres du Time Manager.
	Voyant Charge de linge maximale. Le symbole MAX clignote lorsque la charge de linge dépasse la charge maximale prévue pour le programme sélectionné.
	Indicateur d'ajout de linge. S'allume au début de la phase de lavage pour indiquer que l'utilisateur peut encore interrompre le cycle de lavage et ajouter du linge.
	Voyant de nettoyage du tambour.
	voyant Nuit.
	Voyant Arrêt cuve pleine.
	La zone d'essorage : Voyant de vitesse d'essorage Voyant Sans essorage. La phase d'essorage est désactivée.
	Voyant de phase Vapeur.
	Voyant de phase anti-froissage. Lisez le paragraphe Vapeur Plus pour plus de détails.

6. MANETTES ET TOUCHES

6.1 Introduction



Les options / fonctions ne sont pas disponibles avec tous les programmes de lavage. Vérifiez la compatibilité entre les options / fonctions et les programmes de lavage dans le « Tableau des programmes ». Une option / fonction peut exclure l'autre ; dans ce cas, l'appareil ne permet pas de programmer des options / fonctions incompatibles.

6.2 Marche/Arrêt

Appuyez sur cette touche pendant quelques secondes pour allumer ou éteindre l'appareil. Deux signaux sonores différents retentissent lorsque vous allumez ou éteignez l'appareil.

La fonction Veille éteint automatiquement l'appareil au bout de plusieurs minutes pour réduire la consommation d'énergie. Par conséquent, dans certains cas, il se peut que vous deviez le rallumer.

Pour plus de détails, reportez-vous au paragraphe « Veille » du chapitre « Utilisation quotidienne ».

6.3 Temp.

Lorsque vous sélectionnez un programme de lavage, l'appareil propose automatiquement une température par défaut.

Appuyez à plusieurs reprises sur cette touche jusqu'à ce que la température souhaitée s'affiche.

Lorsque **_ _ *** s'affiche, l'appareil ne chauffe pas l'eau.

6.4 Essorage

Lorsque vous sélectionnez un programme, l'appareil règle automatiquement la vitesse d'essorage maximale, sauf avec le programme Denim. Cette option vous permet de modifier la vitesse d'essorage par défaut.

Appuyez à plusieurs reprises sur cette touche pour :

- **Diminuer la vitesse d'essorage.** Seules les vitesses disponibles pour le programme sélectionné s'affichent.
- Options d'essorage supplémentaires **Sans**

essorage – – –.

Sélectionnez cette option pour éliminer toutes les phases d'essorage. L'appareil effectue uniquement la phase de vidange du programme de lavage sélectionné. Sélectionnez cette option pour les textiles très délicats. Certains programmes de lavage utilisent une quantité d'eau plus importante lors de la phase de rinçage.

- Activez l'option **Arrêt cuve pleine** . L'essorage final est annulé. L'eau du dernier rinçage n'est pas évacuée afin d'éviter le froissage du linge. Le programme de lavage se termine avec de l'eau dans le tambour.

Le voyant  s'allume. Le couvercle reste fermé et le tambour tourne régulièrement pour éviter que le linge ne se froisse. Vous devez vidanger l'eau pour pouvoir ouvrir le couvercle.

Si vous appuyez sur la touche Départ/Pause  l'appareil effectue une phase d'essorage et vidange l'eau.



L'appareil vidange l'eau automatiquement au bout d'environ 18 heures.

- Activez l'option **Nuit** . Les phases d'essorage intermédiaire et final sont supprimées et le programme se termine avec de l'eau dans le tambour. Cela réduit le froissage du linge.

L'indicateur s'  s'allume. Le couvercle reste verrouillé. Le tambour tourne régulièrement pour éviter que le linge ne se froisse. Vous devez vidanger l'eau pour pouvoir ouvrir le couvercle.

Ce programme étant très silencieux, il peut être utilisé de façon optimale la nuit, aux heures creuses, lorsque les tarifs de l'électricité sont plus bas. Certains

programmes utilisent plus d'eau lors du rinçage.

Si vous appuyez sur la touche Départ/Pause , l'appareil n'effectue que la phase de vidange.



L'appareil vidange l'eau automatiquement au bout d'environ 18 heures.

6.5 Prélavage

Avec cette option, vous pouvez ajouter une phase de prélavage à un programme de lavage.

Le voyant correspondant au-dessus de la touche tactile s'allume.

Utilisez cette option pour ajouter une phase de prélavage à 30 °C avant la phase de lavage.

Cette option est recommandée pour le linge très sale, tout particulièrement s'il contient du sable, de la poussière, de la boue ou d'autres particules solides.



Cette option permet de prolonger la durée du programme.

6.6 Taches

Appuyez sur cette touche pour ajouter la phase Taches à un programme.

Le voyant correspondant s'allume au-dessus de la touche.

Utilisez cette option pour le linge très taché.

Si vous sélectionnez cette option, placez le détachant dans le compartiment .



Cette option allonge la durée du programme.
Cette option n'est pas disponible avec des températures de lavage inférieures à 40 °C.

6.7 Rinçage Plus permanent

Cette option permet d'ajouter quelques rinçages en fonction du programme de lavage sélectionné.

Utilisez cette option pour les personnes souffrant d'allergies aux résidus de lessive ou ayant une peau sensible.



Cette option allonge la durée du programme.

L'indicateur correspondant au-dessus de la touche s'allume et reste activé pendant les cycles suivants jusqu'à ce que cette option soit désactivée.

6.8 Permanent Douceur Plus

Sélectionnez cette option pour optimiser la distribution d'assouplissant et rendre le linge plus doux.



Recommandé lorsque vous utilisez de l'assouplissant.



Cette option allonge la durée du programme.

L'indicateur correspondant au-dessus de la touche s'allume et reste activé pendant les cycles suivants jusqu'à ce que cette option soit désactivée.

6.9 Vapeur Plus

Appuyez sur cette touche pour régler le niveau de vapeur. Ce réglage n'est possible que pour les programmes qui disposent de la fonction vapeur. Le tambour effectue des mouvements doux pendant environ 30 minutes. La durée de la phase vapeur change en fonction de votre sélection. Lorsque l'option Vapeur Plus est sélectionnée, le programme se termine par une phase anti-froissage lors de laquelle le tambour tourne de temps en temps pour éviter les plis. L'affichage indique  et  et la touche Départ/Pause  est également allumé. À la fin de la phase anti-froissage, le tambour s'arrête définitivement, le voyant s'éteint et la porte se déverrouille.

L'utilisateur peut à tout instant mettre fin à la phase anti-froissage :

- en appuyant sur la touche Marche/Arrêt pendant quelques secondes pour mettre en fonctionnement ou à l'arrêt l'appareil ;
- en tournant le sélecteur sur une autre position.



Une petite quantité de linge aide à obtenir de meilleurs résultats.

6.10 Départ Différé

Cette option vous permet de différer le départ du programme à un moment qui vous convient mieux.

Appuyez à plusieurs reprises sur la touche pour sélectionner le délai souhaité. La durée augmente par paliers d'une heure jusqu'à 20 heures.

L'indicateur et le départ différé choisi s'affichent. Après avoir appuyé sur la touche Départ/Pause , l'appareil commence le décompte et le couvercle est verrouillé.

6.11 Time Manager

Cette option vous permet d'écourter le programme en fonction de la quantité de linge et du degré de salissure.

Lorsque vous sélectionnez un programme de lavage, sa durée par défaut s'affiche ainsi que ----- tirets.

Appuyez sur la touche Time Manager pour réduire la durée du programme selon vos besoins. La nouvelle durée du programme s'affiche, et le nombre de tirets diminuera en conséquence :

----- convient à une pleine charge de linge normalement sale.

---- un cycle rapide pour une pleine charge de linge légèrement sale.

-- un cycle très rapide pour une charge plus réduite de petits vêtements peu sales (demi-charge max. recommandée).

- le cycle le plus court pour rafraîchir une petite quantité de linge.

Time Manager est uniquement disponible avec les programmes du tableau.

Voyant	Coton	Synthétiques
----- 1)	■	■
----	■	■
---	■	■
--	■	■
-	■	■

1) Durée par défaut pour tous les programmes.

Time Manager avec les programmes vapeur

Lorsque vous sélectionnez un programme vapeur, cette touche vous permet de choisir entre trois niveaux de vapeur. La durée du programme est réduite en conséquence :

- --- : maximale.
- -- : moyenne.
- - : minimale.





Sur certains appareils, la durée du programme est réduite mais aucun tiret ne s'affiche.

6.12 Départ/Pause

Appuyez sur la touche Départ/Pause pour démarrer l'appareil, le mettre en pause ou interrompre un programme en cours.

7. PROGRAMMES

7.1 Tableau des programmes

Programme Température par défaut Plage de températures	Vitesse d'essorage de référence Plage de vitesses d'essorage	Charge maximale	Description du programme (Type de charge et degré de salissure)
Programmes de lavage			
Eco 40-60 40 °C 1)	1300 tr/min (1300 - 400 tr/min)	7 kg	Coton blanc et coton grand teint. Articles normalement sales. La consommation d'énergie diminue et la durée du programme de lavage est prolongée, pour garantir de bons résultats de lavage.
Coton 40 °C 90 °C - Froid	1300 tr/min (1300 - 400 tr/min)	7 kg	Coton blanc et couleurs. Vêtements normalement, légèrement et très sales.
Synthétiques 40 °C 60 °C - Froid	1200 tr/min (1200 - 400 tr/min)	3 kg	Articles en textiles synthétiques ou mélangés. Articles normalement sales.
Déliçats 30 °C 40 °C - Froid	1200 tr/min (1200 - 400 tr/min)	2 kg	Textiles délicats tels que l'acrylique, la viscose et les tissus mélangés nécessitant un lavage en douceur. Vêtements normalement et légèrement sales.
Programmes vapeur 			
 Défroisser		1 kg	Coton, synthétiques et articles en textiles mélangés. Cycle spécial vapeur sans lavage qui peut être utilisé pour préparer votre linge sec au repassage ou pour rafraîchir des vêtements portés une fois ²⁾ . Ce programme réduit les plis et les odeurs ³⁾ et détend les fibres. Une fois le programme terminé, sortez rapidement le linge du tambour. Après un programme Vapeur, le repassage est facilité. N'utilisez aucun produit de lavage ! Si nécessaire, retirez les taches en lavant ou en utilisant un détachant localisé. Les programmes Vapeur n'effectuent pas de cycle de lavage hygiénique. Ne sélectionnez pas de programme Vapeur avec ces types d'articles : <ul style="list-style-type: none"> • Linge non adapté au sèche-linge. • Articles portant une étiquette « Séchage à sec uniquement ».

Programme Température par défaut Plage de températures	Vitesse d'essorage de référence Plage de vitesses d'essorage	Charge maximale	Description du programme (Type de charge et degré de salissure)
--	---	-----------------	---



Cashmere

1 kg

Laine et cachemire. Programme court pour rafraîchir jusqu'à 1 kg d'articles en laine et en cachemire lavables à la main, sans lavage. Pour de plus petites charges, la durée du programme peut être encore réduite en utilisant l'option Time Manager.

⚠ AVERTISSEMENT!

N'utilisez pas ce programme pour les articles en laine portant la mention « Lavage à sec uniquement » sur l'étiquette.

Programmes spéciaux

Essorage/Vidange	1300 tr/min (1300 - 400 tr/min)	7 kg	Tous textiles, excepté la laine et les tissus délicats. Pour essorer le linge et vidanger l'eau dans le tambour.
------------------	------------------------------------	------	---

Rinçage	1300 tr/min (1300 - 400 tr/min)	7 kg	Tous textiles, excepté la laine et les tissus délicats. Programme pour rincer et essorer le linge. La vitesse d'essorage par défaut correspond à la vitesse utilisée pour essorer les articles en coton. Réduisez la vitesse d'essorage en fonction du type de linge. Si nécessaire, sélectionnez la fonction Rinçage Plus pour ajouter des rinçages. Avec une vitesse d'essorage peu élevée, l'appareil effectue des rinçages délicats et un essorage court.
---------	------------------------------------	------	--

Programmes supplémentaires

Doudounes 40 °C 60 °C - Froid	800 tr/min (800 - 400 tr/min)	2 kg	Programme spécial pour une doudoune, couverture, couette, couvre-lit en textile synthétique , etc.
-------------------------------------	----------------------------------	------	---

Rapide 14min 30 °C	800 tr/min (800 - 400 tr/min)	1,5 kg	Synthétiques et articles avec tissus mélangés. Vêtements légèrement sales et à rafraîchir.
-----------------------	----------------------------------	--------	---

Sport 30 °C 40 °C - Froid	1200 tr/min (1200 - 400 tr/min)	3 kg	Vêtements de sport en textiles mélangés. Vêtements légèrement sales ou à rafraîchir.
---------------------------------	------------------------------------	------	---

Programme Température par défaut Plage de tempé- ratures	Vitesse d'essorage de référen- ce Plage de vi- tesses d'es- sorage	Charge maxi- male	Description du programme (Type de charge et degré de salissure)
--	--	-------------------------	--



Outdoor
30 °C
40 °C - Froid



1200 tr/min
(1200 - 400 tr/
min) 2 kg⁴⁾
1 kg⁵⁾



N'utilisez pas d'adoucissant et assurez-vous que le compartiment lavage ne contient pas de résidus d'adoucissant.

Articles de sport synthétiques. Ce programme est conçu pour laver en douceur les vêtements de sport modernes, également pour les vêtements destinés à la gym, au cyclisme, au jogging, et aux vêtements d'extérieur similaires. La charge de linge recommandée est de 2 kg.

Textiles imperméables, respirants et hydrofuges. Ce programme peut également être utilisé comme phase de réimperméabilisation. Il est spécialement conçu pour traiter les vêtements dotés d'un revêtement hydrophobe. Pour effectuer un cycle de réimperméabilisation, procédez comme suit :

- Versez la lessive dans le compartiment .
- Versez un produit de restauration de l'imperméabilité pour vêtements imperméables dans le compartiment pour l'adoucissant .
- Réduisez la charge de linge à 1 kg.



Pour améliorer l'action du produit de réimperméabilisation, faites sécher le linge dans un sèche-linge, en sélectionnant le programme de séchage Outdoor (si disponible, et si l'étiquette d'entretien du vêtement indique que le séchage en machine est autorisé).

Denim 30 °C 40 °C - Froid	800 tr/min (1200 - 400 tr/ min)	2 kg	Programme spécial pour les vêtements en Jean avec une phase de lavage délicate pour minimiser la décoloration et les traces. Pour un meilleur soin, il est recommandé de réduire la charge.
---------------------------------	---------------------------------------	------	--

Programme Température par défaut Plage de températures	Vitesse d'essorage de référence Plage de vitesses d'essorage	Charge maximale	Description du programme (Type de charge et degré de salissure)
--	---	-----------------	--



Laine/Soie
40 °C
40 °C - Froid

1200 tr/min
(1200 - 400 tr/min)

1,5 kg

Lainages lavables en machine, laine lavable à la main et autres textiles portant le symbole « Lavage à la main »⁶⁾.

1) Conformément au règlement de la Commission européenne UE 2019/2023, ce programme à 40 °C peut nettoyer du linge en coton normalement sale déclaré lavable à 40 °C ou 60 °C, dans le même cycle.



Pour la température atteinte dans le linge, la durée du programme et d'autres données, veuillez consulter le chapitre « Valeurs de consommation ».

Les programmes les plus efficaces en matière de consommation énergétique sont généralement ceux qui fonctionnent à des températures plus basses et pendant une durée plus longue.

2) Si vous sélectionnez un programme Vapeur avec un linge sec, à la fin du cycle, le linge peut être humide. Étendez le linge pendant environ 10 minutes pour le sécher.

3) Le programme Vapeur n'élimine pas les odeurs fortes.





4) Programmes de lavage

5) Programme de lavage et phase d'imperméabilisation.

6) Pendant ce cycle, le tambour tourne doucement pour garantir un lavage en douceur. Le tambour peut donner l'impression de ne pas tourner ou de ne pas tourner correctement, mais ce fonctionnement est normal pour ce programme.

Compatibilité des options de programme

Programme	Options Essorage	---			Prélavage ¹⁾	Taches ²⁾	Rinçage Plus	Douceur Plus	Vapeur Plus ²⁾	Départ Différé	Time Manager
Eco 40-60	■		■							■	
Coton	■	■	■	■	■	■	■	■	■	■	■
Synthétiques	■	■	■	■	■	■	■	■	■	■	■
Déliçats	■	■	■	■			■	■		■	
Défroisser										■	■
Cashmere										■	■
Essorage/Vidange	■	■ ³⁾								■	



Programme	Options Essorage				Prélavage ¹⁾	Taches ²⁾	Rinçage Plus	Douceur Plus	Vapeur Plus ²⁾	Départ Différé	Time Manager
Rinçage	■	■	■				■				■
Doudounes	■	■									■
Rapide 14min	■	■	■								■
Sport	■	■	■		■		■				■
Outdoor 	■	■	■				■				■
Denim	■	■	■	■		■	■	■	■	■	■
Laine/Soie 	■	■	■								■

1) Prélavage et Taches ne peuvent pas être sélectionnées en même temps.

2) Cette option n'est pas disponible avec des températures de lavage inférieures à 40 °C.

3) Si vous sélectionnez l'option Sans essorage, l'appareil effectue uniquement une vidange.

Lessive adaptée pour chaque programme

Programme	Poudre universelle ¹⁾	Produit lessiviel liquide universel	Produit lessiviel liquide pour couleurs	Laine délicate	Programmes spéciaux
Eco 40-60	▲	▲	▲	--	--
Coton	▲	▲	▲	--	--
Synthétiques	▲	▲	▲	--	--
Déliçats	--	--	--	▲	▲
Doudounes	--	--	--	▲	▲
Rapide 14min	--	▲	▲	--	--
Sport	--	▲	▲	--	▲
Outdoor 	--	--	--	▲	▲
Denim	--	--	▲	▲	▲
Laine/Soie 	--	--	--	▲	▲

1) À une température supérieure à 60 °C, l'utilisation de détergent en poudre est recommandée.

▲ = Recommandé

-- = Déconseillé

7.2 Woolmark Premium Wool Care - Bleu



Le cycle de lavage de la laine de cet appareil a été testé et approuvé par The Woolmark Company pour le lavage des vêtements en laine portant une étiquette « lavage à la main », à condition que les produits soient lavés conformément aux instructions figurant sur l'étiquette du vêtement et à celles émises par le fabricant de cette machine à laver. M1145

8. CONFIGURATIONS

8.1 Signaux sonores

Cet appareil est doté de signaux sonores différents qui se déclenchent lorsque :

- Vous mettez en fonctionnement l'appareil (signal court spécial).
- Vous mettez à l'arrêt l'appareil (signal court spécial).
- Vous appuyez sur une touche (clic).
- Vous avez effectué une mauvaise sélection (3 signaux courts).
- Le programme est terminé (suite de signaux sonores pendant environ 1 minute).
- L'appareil présente une anomalie de fonctionnement (suite de signaux courts pendant environ 5 minutes).

Pour **désactiver/activer** les signaux sonores, sélectionnez un programme, appuyez sur la touche Prélavage et Taches simultanément pendant environ 2 secondes. L'affichage indique On/Off.



Si vous désactivez les signaux sonores, ils continueront à retentir si l'appareil présente une anomalie de fonctionnement.

8.2 Sécurité enfants

Avec cette option, vous pouvez empêcher les enfants de jouer avec le bandeau de commande.

Pour **activer/désactiver** cette option, maintenez la touche Vapeur Plus enfoncée

jusqu'à ce que  apparaisse/disparaisse sur l'affichage.

Après avoir éteint l'appareil, cette option restera sélectionnée par défaut.

La Sécurité enfants n'est pas disponible pendant les quelques secondes suivant la mise en marche de l'appareil.

8.3 Compteur des heures de fonctionnement

Il est possible de visualiser la durée totale de fonctionnement de l'appareil en heures, à partir de la première mise sous tension. Cette valeur calcule la durée de fonctionnement des cycles (n'inclut pas les pauses et le délai de départ différé). Pour visualiser cette valeur, procédez comme suit :

1. Mettez en fonctionnement l'appareil en appuyant sur la touche Marche/Arrêt.
2. Tournez le sélecteur de programme sur le programme Eco 40-60 (1ère position vers la droite).
3. Maintenez la touche Prélavage et Taches enfoncée pendant quelques secondes (dans les 10 secondes après avoir mis en fonctionnement. Après ces 10 secondes, la combinaison de touches active et désactive les signaux sonores).
4. Au bout de 3 secondes, le nombre total d'heures de fonctionnement de l'appareil s'affiche : par exemple pour 1276 heures, le texte Hr s'affiche pendant 2 secondes, 12 (milliers et centaines) pendant 2 secondes et 76 (dizaines et unités).



Si la procédure ne fonctionne pas (en raison d'un délai écoulé, d'une mauvaise position du sélecteur de programme ou d'une combinaison de touches erronée), mettez à l'arrêt l'appareil et répétez la procédure depuis le début.

8.4 Réinitialisation usine

Cette fonction permet de restaurer les options d'usine par défaut. Pour **activer** cette option suivez les étapes ci-dessous:

1. Mettez en fonctionnement l'appareil en appuyant sur la touche Marche/Arrêt.
2. Tournez le sélecteur de programme sur le programme Synthétiques (3e position vers la droite).

3. Maintenez la touche Prélavage et Taches enfoncée pendant quelques secondes (dans les 10 secondes après avoir mis en fonctionnement. Après ces 10 secondes, la combinaison de touches active et désactive les signaux sonores).
4. L'affichage indique - - - pendant environ 5 secondes.



Si la procédure ne fonctionne pas (en raison d'un délai écoulé, d'une mauvaise position du sélecteur de programme ou d'une combinaison de touches erronée), mettez à l'arrêt l'appareil et répétez la procédure depuis le début.

9. UTILISATION QUOTIDIENNE



AVERTISSEMENT!

Reportez-vous aux chapitres concernant la sécurité.

9.1 Activation de l'appareil

1. Branchez l'appareil sur le secteur.
2. Ouvrez le robinet d'eau.
3. Appuyez sur la touche Marche/Arrêt pour allumer l'appareil.

Un signal court retentit.

9.2 Chargement du linge

1. Ouvrez le couvercle de l'appareil.

2. Appuyez sur la touche **A**.

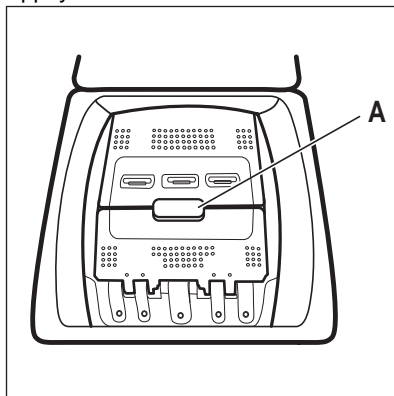

Le tambour s'ouvre automatiquement.

3. Placez les articles un à un dans le tambour.
4. Dépliez-les le plus possible avant de les placer dans l'appareil.
5. Fermez le tambour et le couvercle.

⚠ ATTENTION!

- Veillez à ne pas trop surcharger le tambour.
- Veillez à ce qu'aucun linge ne reste entre le joint et l'appareil et à fermer correctement le tambour.
- Laver des articles très tachés par de l'huile ou de la graisse ou utiliser du parfum pourrait endommager les pièces en caoutchouc de l'appareil.

9.3 Boîte à produits. Utilisation du produit de lavage et des additifs

1. Dosez les produits de lavage et l'assouplissant.
2. Mettez le produit de lavage et l'assouplissant dans les compartiments réservés.



Respectez les instructions figurant sur l'emballage des lessives.

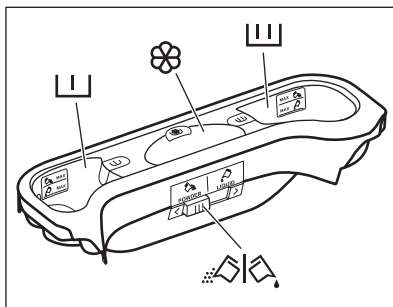

Compartiment pour la phase de pré-lavage. Les repères MAX sont les niveaux maximaux de la quantité de produit de lavage (en poudre ou liquide).
Lorsque vous sélectionnez un programme avec une phase de détachage, ajoutez du produit de lavage (en poudre ou liquide).



Compartiment pour la phase de lavage. Les repères MAX sont les niveaux maximaux de la quantité de produit de lavage (en poudre ou liquide).



Compartiment réservé aux additifs liquides (assouplissant textile, amidon).

Le repère **M** est le niveau maximal pour les additifs liquides.



Volet pour produit de lavage en poudre ou liquide.

9.4 Lessive liquide ou en poudre

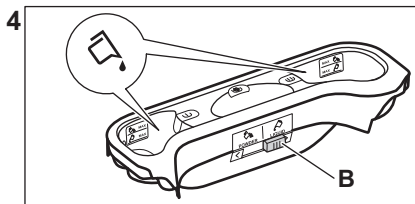
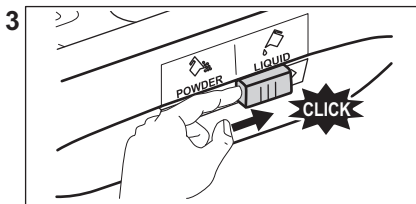
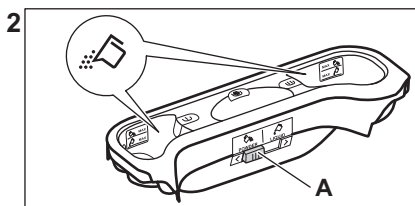
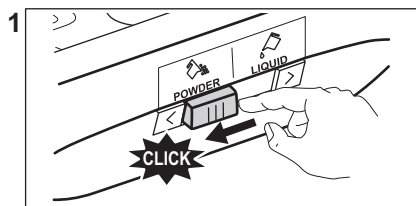

- Position **A** pour la lessive en poudre (réglage d'usine).
- Position **B** pour la lessive liquide.



En cas d'utilisation de lessive liquide :

- N'utilisez pas de lessives liquides gélatineuses ou épaisses.
- le niveau de lessive liquide ne doit pas dépasser le niveau maximum.
- Ne sélectionnez pas la fonction Départ différé.



Si une sélection est **impossible**, un signal sonore retentit et **--** s'affiche.

9.5 Réglage d'un programme

1. Tournez le sélecteur pour choisir le programme de lavage souhaité.

Le voyant de la touche Départ/Pause  clignote.

Une durée indicative pour le programme s'affiche.



2. Pour modifier la température et/ou la vitesse d'essorage, appuyez sur les touches correspondantes.
3. Si nécessaire, sélectionnez une ou plusieurs options en appuyant sur les touches correspondantes. Les indicateurs correspondants s'allument et les informations données changent en conséquence.

9.6 Informations supplémentaires sur l'utilisation quotidienne

Détection de la charge SensiCare System

Le SensiCare ajuste automatiquement la durée du programme en fonction de la charge de linge dans le tambour pour obtenir des résultats de lavage parfaits, en un minimum de temps. Au bout d'environ 30 secondes, l'eau commence à se remplir. La détection SensiCare ne fonctionne que si le programme de lavage est complet et si la durée du programme n'a pas été réduite.

Démarrer un programme

Appuyez sur la touche Départ/Pause  pour lancer le programme. Le voyant correspondant cesse de clignoter et reste allumé. Le programme démarre, la porte est verrouillée. Le voyant  s'affiche.

Démarrer un programme avec démarrage différé

1. Appuyez sur le bouton Départ Différé à plusieurs reprises jusqu'à ce que le départ différé souhaité s'affiche.

2. Appuyez sur la touche Départ/Pause ▷||. Le couvercle se verrouille et l'appareil démarre le décompte du départ différé. Le programme démarre automatiquement lorsque le décompte est terminé.

Interruption d'un programme et modification des options.

1. Lorsque le programme est en cours, vous ne pouvez changer que quelques options.

Appuyez sur la touche Départ/Pause ▷||.

2. Modifiez les options. Les informations données sur l'affichage changent en conséquence

3. Appuyez à nouveau sur Départ/Pause ▷||. Le programme de lavage continue.

Annulation d'un programme en cours

- Appuyez sur le bouton Marche/Arrêt pour annuler le programme et mettre l'appareil à l'arrêt. Appuyez à nouveau pour mettre l'appareil en fonctionnement.
- Tournez la molette de sélection sur la position « Réinitialiser » pour activer

l'appareil • . Attendez 2 secondes. Vous pouvez maintenant sélectionner un nouveau programme de lavage.

Vidange de l'eau après la fin du cycle

Si vous avez sélectionné un programme ou une option qui ne vidange pas l'eau du dernier rinçage, n'oubliez pas de vidanger l'eau avant d'ouvrir le capot.

- Appuyez sur le bouton Essorage pour diminuer la vitesse d'essorage proposée par l'appareil
- Appuyez sur Départ/Pause ▷||
- Une fois le programme terminé et le voyant de verrouillage du couvercle  éteint, vous pouvez ouvrir le couvercle.
- Appuyez sur la touche Marche/Arrêt pour mettre à l'arrêt l'appareil.

Fonction Veille

La fonction Veille met automatiquement l'appareil à l'arrêt pour réduire la consommation d'énergie.

10. ENTRETIEN ET NETTOYAGE

AVERTISSEMENT!

Reportez-vous aux chapitres concernant la sécurité.

10.1 Calendrier de nettoyage périodique

Le nettoyage périodique permet de prolonger la durée de vie de votre appareil.

À la fin de chaque cycle, afin d'éviter l'apparition de moisissure et d'odeurs, maintenez la porte du tambour et le distributeur de détergent entrouverts pour permettre la circulation de l'air et éliminer l'humidité à l'intérieur de l'appareil.

Si l'appareil n'est pas utilisé pendant une durée prolongée : fermez le robinet d'eau et débranchez l'appareil.

Calendrier indicatif de nettoyage périodique :

Détartrage	Deux fois par an
Lavage d'entretien	Une fois par mois
Nettoyer le joint du couvercle	Tous les deux mois
Nettoyez le tambour	Tous les deux mois
Nettoyez le distributeur de détergent	Tous les deux mois
Nettoyez le filtre de la pompe de vidange	Deux fois par an
Nettoyez le tuyau d'arrivée d'eau et du filtre de la vanne	Deux fois par an

Les paragraphes suivants expliquent comment vous devez nettoyer chaque partie.

10.2 Enlèvement des objets étrangers



Assurez-vous que les poches sont vides et que tous les éléments libres sont attachés avant de lancer votre cycle.

Enlevez les objets étrangers (tels que les attaches métalliques, les boutons, les pièces, etc.) pouvant se trouver dans les filtres et le tambour. Consultez les paragraphes « Nettoyage du tambour », « Nettoyage de la pompe de vidange » et « Nettoyage du tuyau d'arrivée d'eau et du filtre de la vanne ». Traitez les rideaux avec précautions. Retirez les crochets et placez les rideaux dans un sac de lavage ou une taie d'oreiller. Si nécessaire, contactez le service après-vente agréé.

10.3 Nettoyage externe

Nettoyez uniquement l'appareil à l'eau chaude avec un savon doux. Séchez complètement toutes les surfaces. N'utilisez pas de tampons à récurer ni de matières pouvant causer des rayures.



ATTENTION!

N'utilisez pas d'alcool, de solvants ni de produits chimiques.



ATTENTION!

Ne nettoyez pas les surfaces métalliques avec un détergent à base de chlore.

10.4 Détartrage



Si l'eau de votre région est dure ou moyennement dure, nous vous recommandons d'utiliser un adoucisseur d'eau pour lave-linge.

Examinez régulièrement le tambour à la recherche de tartre.

Les produits de lavage habituels contiennent déjà des agents adoucisseurs d'eau, mais nous vous recommandons d'effectuer un cycle de lavage, tambour vide, avec un produit de détartrage.



Respectez toujours les instructions figurant sur l'emballage du produit.

10.5 Lavage d'entretien

L'utilisation répétée et prolongée des programmes basse température peut entraîner des dépôts de produit de lavage, des résidus pelucheux et une augmentation des bactéries à l'intérieur du tambour et de la cuve. Ceci peut entraîner la formation de mauvaises odeurs et de moisissures. Pour éliminer ces dépôts et nettoyer l'intérieur de l'appareil, effectuez régulièrement un lavage d'entretien (au moins une fois par mois).



Reportez-vous au chapitre « Nettoyage du tambour ».

10.6 Nettoyage du tambour

Examinez régulièrement le tambour pour éviter le dépôt de particules indésirables.

Des corps étrangers sujets à la rouille dans le linge ou bien l'eau ferrugineuse du robinet peuvent provoquer des dépôts de rouille dans le tambour.

Nettoyez le tambour à l'aide d'un produit spécial pour l'acier inoxydable.



Respectez toujours les instructions figurant sur l'emballage du produit. Ne nettoyez pas le tambour avec des produits de détartrage acides, des produits abrasifs contenant du chlore ou avec de la paille de fer.

Pour un nettoyage complet :

1. Retirez le linge du tambour.
2. Lancez le programme Coton à température maximale.
3. Versez une petite quantité de lessive en poudre dans le tambour vide afin de rincer les éventuels résidus.



Parfois, à la fin d'un cycle, le symbole  peut s'afficher : l'appareil vous recommande d'effectuer un « nettoyage du tambour ». Une fois le nettoyage du tambour terminé, le symbole disparaît.

10.7 Joint du capot

Examinez régulièrement le joint et enlevez tous les objets situés à l'intérieur. Si nécessaire, nettoyez-le en utilisant un agent nettoyant à l'ammoniaque et sans érafler la surface du joint.



Respectez toujours les instructions figurant sur l'emballage du produit.

10.8 Nettoyage du distributeur de lessive

Pour éviter d'éventuels dépôts de lessive séchée ou d'assouplissant coagulé et/ou la formation de moisissures dans le distributeur de lessive, effectuez tous les deux mois la procédure de nettoyage suivante comme expliqué dans les schémas suivants :

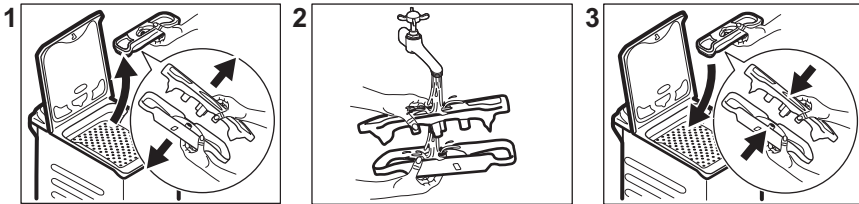

10.9 Nettoyage du filtre de la pompe de vidange

Vérifiez régulièrement le filtre de la pompe de vidange et assurez-vous qu'il est propre.

- Débranchez la fiche d'alimentation de la prise de courant.
 - Ne nettoyez pas la pompe si l'eau de l'appareil est chaude. Attendez que l'eau refroidisse.
 - Ne retirez pas le filtre pendant que l'appareil fonctionne.
 - Dévissez lentement et doucement le filtre jusqu'à ce que l'eau cesse de s'écouler. Une fois l'eau vidangée, le filtre peut être complètement dévissé.
- Nettoyez la pompe de vidange si :**
- L'appareil ne vidange pas l'eau.
 - Le tambour ne tourne pas.
 - L'appareil fait un bruit inhabituel en raison de l'obstruction de la pompe de vidange.
 - Le code d'alarme **E20** s'affiche.

Procédez comme décrit dans les schémas suivants pour nettoyer le filtre de la pompe :

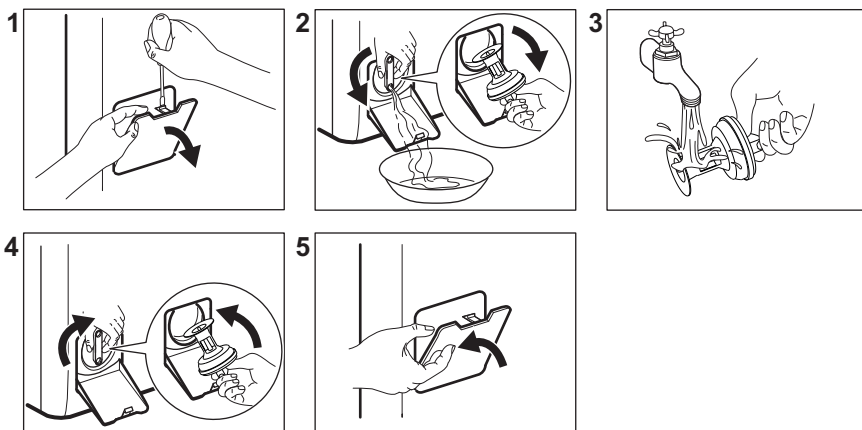

Gardez toujours un chiffon à portée de main pour essuyer l'eau qui peut s'écouler lorsque vous retirez le filtre.

10.10 Nettoyage du tuyau d'arrivée d'eau et du filtre de la vanne

Il est recommandé de nettoyer les deux filtres du tuyau d'arrivée d'eau et de la vanne deux fois par an, pour éliminer les dépôts accumulés avec le temps. Procédez comme décrit dans les schémas suivants pour nettoyer les filtres :

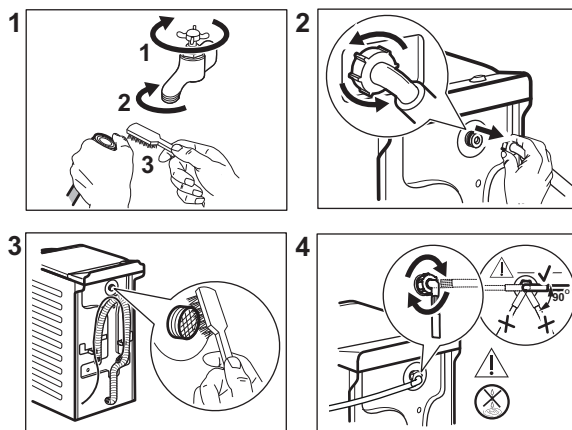

10.11 Vidange d'urgence

Si l'appareil ne peut pas vidanger l'eau, effectuez la même procédure décrite dans le paragraphe « Nettoyage de la pompe de vidange ». Si nécessaire, nettoyez la pompe.

Lorsque vous vidangez l'eau avec la vidange d'urgence, vous devez réactiver le système de vidange :

1. Versez 2 litres d'eau dans le distributeur de produit de lavage pour le lavage principal.
2. Démarrez le programme pour vidanger l'eau.

10.12 Précautions contre le gel

Si l'appareil est installé dans un local où la température peut être négative, évacuez toute l'eau restant dans le tuyau d'alimentation et la pompe de vidange.

1. Débranchez l'appareil de la prise de courant.
2. Fermez le robinet d'eau.
3. Placez les deux extrémités du tuyau d'alimentation dans un récipient et laissez l'eau s'écouler du tuyau.
4. Videz la pompe de vidange. Reportez-vous à la procédure de vidange d'urgence.

5. Une fois que la pompe de vidange est vide, réinstallez le tuyau d'alimentation.

AVERTISSEMENT!

Assurez-vous que la température est supérieure à 0 °C avant d'utiliser à nouveau l'appareil.

Le fabricant ne pourra être tenu pour responsable en cas de dommages dus aux basses températures.

11. VALEURS DE CONSOMMATION

11.1 Commentaire



Le code QR présent sur l'étiquette énergétique fournie avec l'appareil contient un lien Internet vers les informations relatives aux performances de l'appareil dans la base de données EPREL de l'UE. Conservez l'étiquette énergétique à titre de référence avec la notice d'utilisation et tous les autres documents fournis avec cet appareil.

Il est également possible de trouver les mêmes informations dans EPREL à l'aide du lien <https://eprel.ec.europa.eu> avec le nom du modèle et le numéro de produit se trouvant sur la plaque signalétique de l'appareil.

Les valeurs et la durée du programme peuvent différer selon les conditions (telles que la température ambiante, la température et la pression de l'eau, l'importance de la charge et le type de linge, la tension de l'alimentation électrique) et si vous modifiez le réglage par défaut d'un programme.

Conformément au règlement de la Commission UE 2019/2023

Eco 40-60 programme	kg	kWh	Litres	hh:mm	% 1)	°C	tr/min ²⁾
Pleine charge	7	0.824	53.0	3:25	53.00	46	1251
Demi-charge	3,5	0.222	44.0	2:40	53.00	25	1251
Quart de charge	2	0.134	36.0	2:40	55.00	23	1251

1) Humidité résiduelle au terme de la phase d'essorage. Plus la vitesse d'essorage est élevée, plus le bruit est important et moins il reste d'humidité.

2) Vitesse d'essorage maximale

Programmes courants



Ces valeurs sont uniquement indicatives.

Programme	kg	kWh	Litres	hh:mm	% 1)	°C	tr/min ²⁾
Coton ³⁾ 90 °C	7	2.50	90.0	4:10	53.00	85	1300
Coton 60 °C	7	1.65	90.0	3:50	53.00	55	1300
Coton 20° ⁴⁾ 20 °C	7	0.30	90.0	2:50	53.00	20	1300
Synthétiques 40 °C	3	0.55	50.0	2:10	35.00	40	1200
Déliçats ⁵⁾ 30 °C	2	0.35	50.0	1:00	35.00	30	1200
Laine/Soie 30 °C	1,5	0.20	45.0	1:10	30.00	30	1200

1) Humidité résiduelle au terme de la phase d'essorage. Plus la vitesse d'essorage est élevée, plus le bruit est important et moins il reste d'humidité.

2) Indicateur de référence de la vitesse d'essorage.

3) Convient au lavage de textiles très sales.

4) Convient pour laver les articles en coton peu sales, synthétiques et mixtes.

5) Il fonctionne également comme un cycle de lavage rapide pour le linge légèrement sale.

Consommation d'énergie pour différents modes

Arrêt (W)	Veille (W)	Départ différé (W)
0.50	0.50	4.00

La durée en mode Arrêt/Veille est de 15 minutes au maximum.

12. GUIDE D'UTILISATION RAPIDE

12.1 Utilisation quotidienne

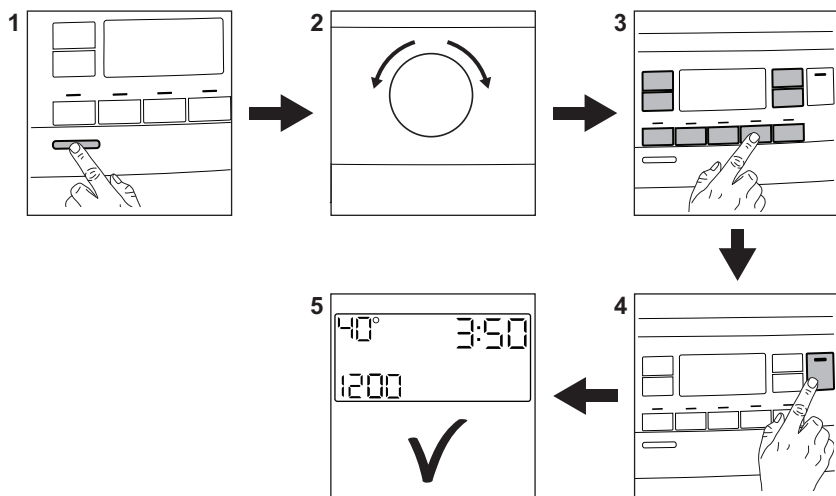

Branchez la prise de l'appareil sur le secteur.

Ouvrez le robinet d'eau.

Introduisez le linge.

Versez le détergent et les autres additifs dans le compartiment spécial du distributeur de produit de lavage.

1. Appuyez sur la touche **Marche/Arrêt** pour mettre l'appareil en marche.
2. Tournez le sélecteur pour choisir le programme souhaité.
3. Sélectionnez les options souhaitées en utilisant les touches correspondantes.
4. Pour démarrer le programme, appuyez sur la touche **Départ/Pause** .
5. L'appareil démarre.

À la fin du programme, sortez le linge.

Appuyez sur la touche **Marche/Arrêt** pour éteindre l'appareil.

12.2 Entretien et nettoyage

Le nettoyage périodique permet de prolonger la durée de vie de votre appareil.

À la fin de chaque cycle, afin d'éviter l'apparition de moisissure et d'odeurs, maintenez la porte du tambour entrouverte pour permettre la circulation de l'air et éliminer l'humidité à l'intérieur de l'appareil.

Si l'appareil n'est pas utilisé pendant une durée prolongée : fermez le robinet d'eau et débranchez l'appareil.

Détartrage	Deux fois par an
Lavage d'entretien	Une fois par mois
Nettoyer le joint du couvercle	Tous les deux mois
Nettoyer le tambour	Tous les deux mois
Nettoyer le distributeur de détergent	Tous les deux mois
Nettoyer le filtre de la pompe de vidange	Deux fois par an
Nettoyer le tuyau d'arrivée d'eau et du filtre de la vanne	Deux fois par an

Gardez les pièces en plastique à l'écart, en particulier près de la zone du tiroir à détergent, retirez l'excédent de déversement.

Les paragraphes suivants expliquent comment vous devez nettoyer chaque partie.

Enlèvement des objets étrangers



Assurez-vous que les poches sont vides et que tous les éléments libres sont attachés avant de lancer votre cycle.



Enlevez les objets étrangers (tels que les attaches métalliques, les boutons, les pièces, etc.) pouvant se trouver dans les filtres et le tambour. Si nécessaire, contactez le service après-vente agréé.

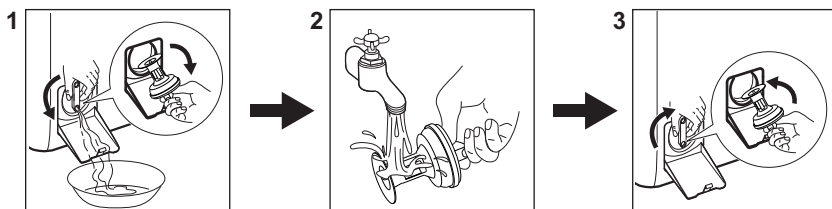

Nettoyage du filtre de la pompe de vidange

Nettoyez régulièrement le filtre, tout particulièrement si le code d'alarme **E20** s'affiche.



12.3 Programmes

Programmes	Charge	Description du produit
Eco 40-60 ¹⁾	7 kg	Coton blanc et de couleur Vêtements normalement sales.
Coton	7 kg	Coton blanc et couleurs.
Synthétiques	3 kg	Articles en textiles synthétiques ou mélangés.
Déliçats	2 kg	Articles en textiles délicats tels que l'acrylique, la viscose ou le polyester.
 Défroisser	1 kg	Programme vapeur pour les articles en coton, les textiles synthétiques et délicats.
 Cashmere	1 kg	Programme vapeur pour la laine et le cachemire.
Essorage/Vidange	7 kg	Tous textiles, excepté la laine et les tissus délicats. Programme pour essorer et vidanger l'eau.
Rinçage	7 kg	Tous textiles, excepté la laine et les tissus délicats. Programme pour le rinçage et l'essorage.
Doudounes	2 kg	Une couverture synthétique, des vêtements rembourrés, des couettes, des vestes.

Programmes	Charge	Description du produit
Rapide 14min	1,5 kg	Articles en coton et synthétiques légèrement sales ou portés une seule fois.
Sport	3 kg	Vêtements de sport.
 Outdoor	2 kg ²⁾ 1 kg ³⁾	Vêtements de sport d'extérieur modernes.
Denim	2 kg	Vêtements en jean.
 Laine/Soie	1,5 kg	Laine lavable en machine, la laine lavable à la main et textiles délicats.

1) Conformément au règlement de la Commission européenne UE 2019/2023, ce programme à 40 °C peut nettoyer du linge en coton normalement sale déclaré lavable à 40 °C ou 60 °C, dans le même cycle.



Pour la température atteinte dans le linge, la durée du programme et d'autres données, veuillez consulter le chapitre « Valeurs de consommation ».
Les programmes les plus efficaces en matière de consommation énergétique sont généralement ceux qui fonctionnent à des températures plus basses et pendant une durée plus longue.

2) Programmes de lavage

3) Programme de lavage et phase d'imperméabilisation.

Charger l'appareil à la **capacité maximale indiquée pour chaque programme permet**

de réduire la consommation d'énergie et d'eau.

Lessive adaptée pour chaque programme

Programme	Poudre universelle ¹⁾	Produit lessiviel liquide universel	Produit lessiviel liquide pour couleurs	Laine délicate	Programmes spéciaux
Eco 40-60	▲	▲	▲	--	--
Coton	▲	▲	▲	--	--
Synthétiques	▲	▲	▲	--	--
Délicats	--	--	--	▲	▲
Doudounes	--	--	--	▲	▲
Rapide 14min	--	▲	▲	--	--
Sport	--	▲	▲	--	▲
Outdoor 	--	--	--	▲	▲
Denim	--	--	▲	▲	▲

Programme	Poudre universelle ¹⁾	Produit lessiviel liquide universel	Produit lessiviel liquide pour couleurs	Laine délicate	Programmes spéciaux
-----------	----------------------------------	-------------------------------------	---	----------------	---------------------

Laine/Soie 

--

--

--

▲

▲

1) À une température supérieure à 60 °C, l'utilisation de détergent en poudre est recommandée.

-- = non recommandé ▲ = recommandé

12.4 Type et quantité de détergent.

- Utilisez uniquement des produits de lavage et autres traitements spécialement conçus pour les lave-linge. Suivez d'abord ces règles générales :

- lessives en poudre (également des pastilles et des détergents à dose unique) pour tous les types de tissus, à l'exception des tissus délicats. Préférez les lessives en poudre contenant un agent blanchissant pour le blanc et la désinfection du linge,
- Lessives liquides (également des détergents à dose unique), de préférence pour les programmes de lavage à basse température (60 °C max.) pour tous les types de textiles, ou lessives spéciales pour les lainages uniquement.

- Ne mélangez pas différents types de détergents.

- Utilisez moins de lessive si :
 - vous lavez une petite charge,
 - le linge est légèrement sale,
 - d'importantes quantités de mousse de forment pendant le lavage.
- Si vous utilisez des tablettes ou des capsules de détergent, mettez-les toujours à l'intérieur du tambour, et non pas dans le distributeur de produit de lavage et suivre les recommandations du fabricant.

Une quantité insuffisante de détergent peut causer :

- résultats de lavage insatisfaisants,
- charge de lavage grise,
- vêtements gras,
- moisissure dans l'appareil.

Une quantité excessive de détergent peut causer :

- abondance de mousse,
- efficacité de lavage réduite,
- rinçage non adéquat,
- un impact accru pour l'environnement.

13. CODES D'ALARME ET DÉFAILLANCES POSSIBLES

L'appareil ne démarre pas ou se met à l'arrêt en cours de programme. Dans un premier temps, essayez de trouver une solution au problème (reportez-vous aux tableaux).

AVERTISSEMENT!

Mettez à l'arrêt l'appareil avant de procéder à la vérification.

Problème

Solution possible

E 10

L'appareil ne se remplit pas d'eau correctement.

- Assurez-vous que l'arrivée d'eau est ouverte.
- Assurez-vous que la pression de l'alimentation d'eau est suffisante. Pour cela, contactez les autorités locales en charge de l'eau.
- Assurez-vous que l'arrivée d'eau n'est pas bouchée.
- Assurez-vous que le tuyau de raccordement ne présente pas d'enchevêtrements, de dommages ni de plis.
- Assurez-vous que le raccordement du tuyau d'arrivée d'eau est correct.
- Assurez-vous que le filtre du tuyau d'arrivée d'eau et le filtre de la vanne ne sont pas obstrués.

E 20

La machine ne vidange pas l'eau.

- Assurez-vous que le siphon n'est pas bouché.
- Assurez-vous que le tuyau de vidange n'est pas tordu ni plié.
- Assurez-vous que le filtre de vidange n'est pas obstrué. Nettoyez le filtre si nécessaire.
- Assurez-vous que le tuyau de vidange est correctement raccordé.
- Sélectionnez le programme de vidange si vous sélectionnez un programme sans phase de vidange.
- Sélectionnez le programme de vidange si vous sélectionnez une option se terminant avec de l'eau dans la cuve.

E 9 1

Panne interne. Il n'y a aucune communication entre les composants électroniques de l'appareil.

- Le programme ne s'est pas terminé correctement ou l'appareil s'est mis à l'arrêt trop tôt. Mettez à l'arrêt l'appareil et remettez-le en fonctionnement.
- Si le code d'alarme s'affiche à nouveau, contactez le service après-vente agréé.

E 40

L'alimentation électrique est instable.

- Attendez que l'alimentation électrique se stabilise.

E F 0

Le dispositif anti-inondation est activé.

- Débranchez l'appareil et fermez le robinet d'arrivée d'eau. Veuillez contacter le service après-vente agréé.

Si le problème persiste, contactez le service après-vente agréé. Les informations nécessaires au service après-vente figurent sur la plaque signalétique.

*Certains codes d'alarme peuvent ne pas se déclencher. Sujet à modification sans préavis.

14. CONSIDÉRATIONS ENVIRONNEMENTALES

Recyclez les matériaux portant le symbole . Placez l'emballage dans les conteneurs appropriés pour le recycler. Contribuez à la protection de l'environnement et de la santé humaine en recyclant les déchets des appareils électriques et électroniques. Ne

jetez pas les appareils marqués du symbole  avec les déchets ménagers. Rapportez ce produit à votre centre de recyclage local ou renseignez-vous auprès de votre mairie.

FR Concerne la France uniquement :



FR

Cet appareil,
ses accessoires
et cordons
se recyclent

REPRISE
À LA LIVRAISON



OU

À DÉPOSER
EN MAGASIN



OU

À DÉPOSER
EN DÉCHÈTERIE



Points de collecte sur www.quefairedemesdechets.fr
Privilégiez la réparation ou le don de votre appareil !



FR





electrolux.com

135940310-A-482025



CE