

IT - Installazione con motore sulla cappa.

EN - Installation with motor on the hood.

DE - Installation mit Motor an der Haube.

FR - Installation avec moteur sur la hotte.

ES - Instalación con el motor en la campana.

RU - Установка с двигателем на вытяжке.

PL - Instalacja z silnikiem na okapie.

NL - Installatie met motor op kap.

PT - Instalação com motor na capa.

DK - Installation med motoren på emhætten.

SE - Installation med motor på fläkthuv.

FI - Asennus moottori liesituulettimen päällä.

NO - Installasjon med motor på hetten.

pag. page
Seite str.
str. side
sivu

10

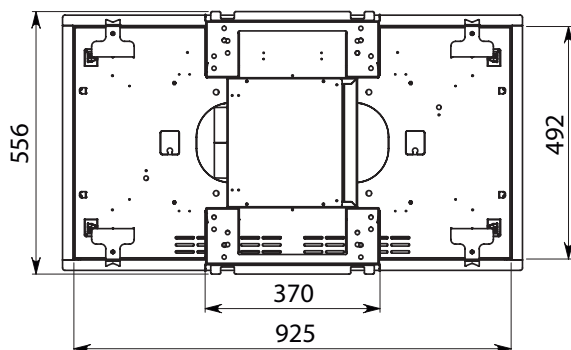
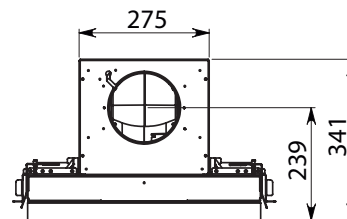
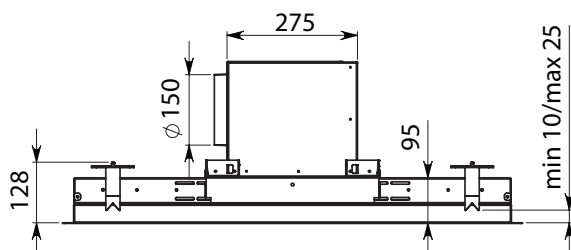
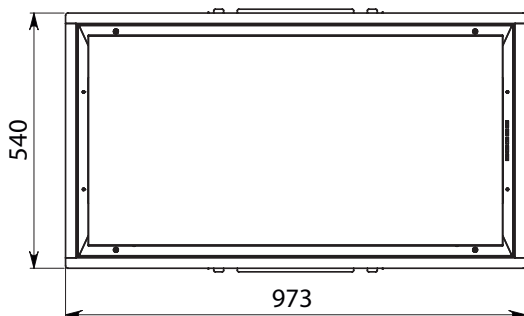
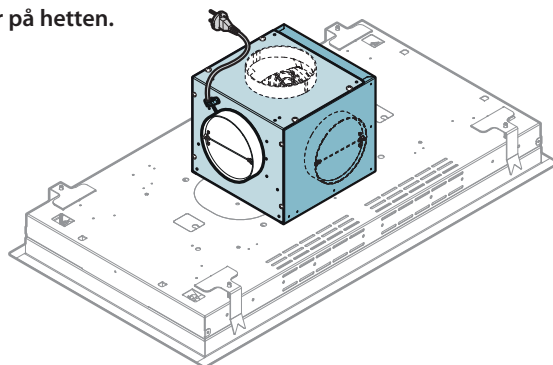

NUBE: 32 KG

DIMENSIONE FORATURA
HOLE SIZES

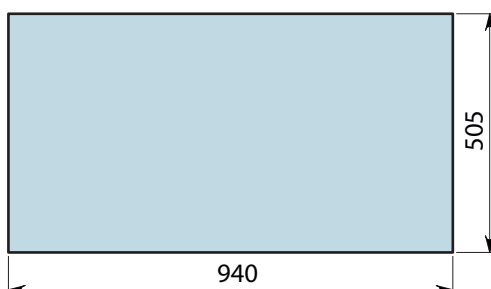

IT - Installazione con motore SLIM.
 EN - Installation with SLIM motor.
 DE - Installation SLIM-Motor.
 FR - Installation avec moteur SLIM.
 ES - Instalación con motor SLIM.
 RU - Установка с двигателем SLIM.
 PL - Instalacja z silnikiem SLIM.
 NL - Installatie met SLIM motor.

PT - Instalação com motor SLIM.
 DK - Installation med motoren SLIM.
 SE - Installation med SLIM-motor.
 FI - Asennus SLIM-moottorilla.
 NO - Installasjon med SLIM-motor.

pag. | page
 Seite | стр.
 str. | side
 sivu

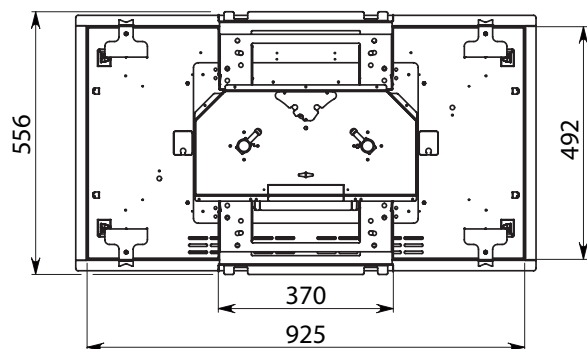
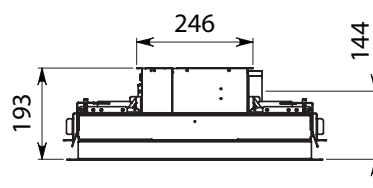
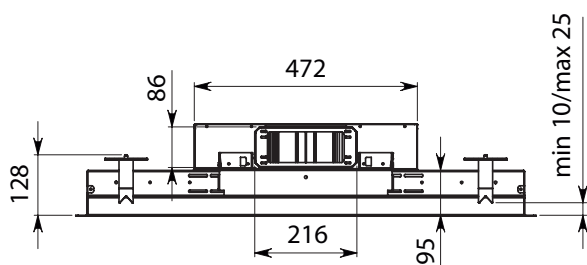
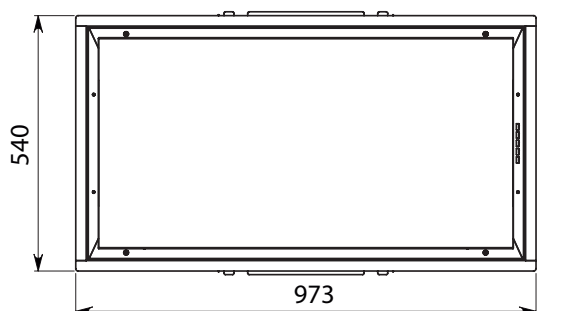
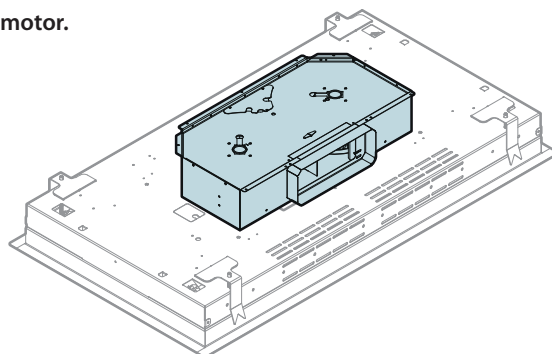

NUBE: 31 KG

DIMENSIONE FORATURA
 HOLE SIZES

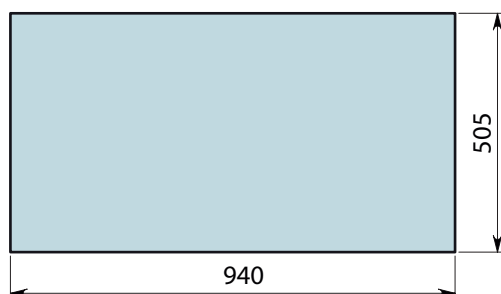

IT - Installazione con kit convogliatore e motore remoto.

EN - Installation with conveyor kit and remote motor.

DE - Installation mit Förder-Kit und getrennt montiertem Motor.

FR - Installation avec kit convoyeur et moteur à distance.

ES - Instalación con kit transportador y motor remoto.

RU - Установка с комплектом воздуховода и удаленным двигателем.

PL - Instalacja z zestawem doprowadzającym i silnikiem zewnętrznym.

NL - Installatie met luchtkanaal en motor op afstand.

PT - Instalação com kit transportador e motor remoto.

DK - Installation med kit med blæser-kappe og fjernmotor.

SE - Installation med transportör-sats och separat monterad motor.

FI - Asennus kanavasarjalla ja etäkäyttömootorilla.

NO - Installasjon med transportørsett og fjernmotor.

pag. | page
Seite | стр.
str. | side
sivu

18

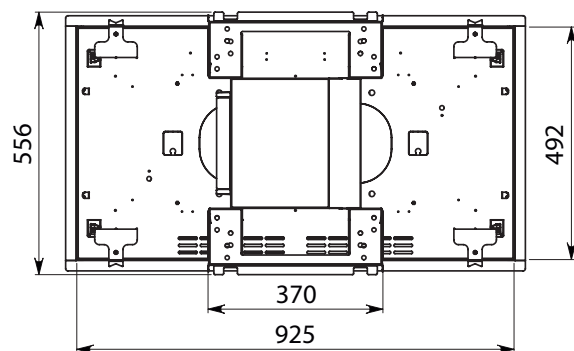
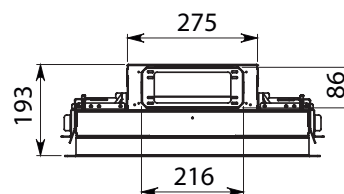
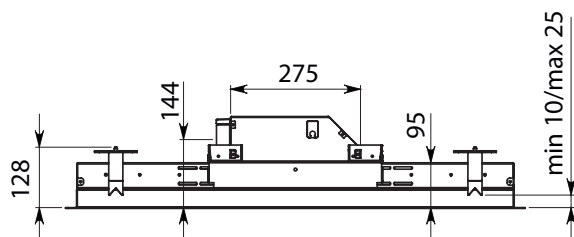
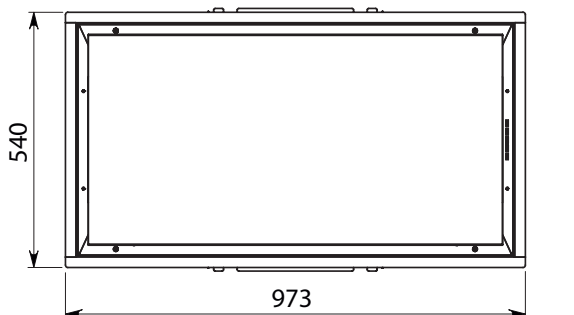
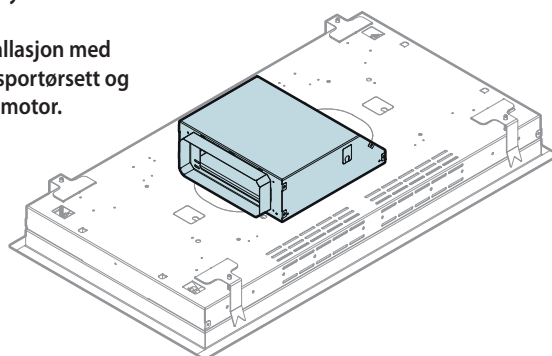

NUBE: 24 KG

DIMENSIONE FORATURA
HOLE SIZES

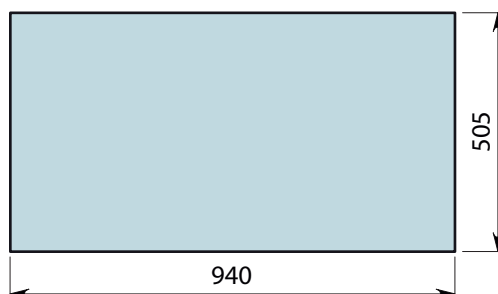

IT - Installazione con motore remoto.

EN - Installation with remote motor.

DE - Installation mit getrennt montiertem Motor.

FR - Installation avec moteur à distance.

ES - Instalación con motor remoto.

RU - Установка с удаленным двигателем.

PL - Instalacja z silnikiem zewnętrznym.

NL - Installatie met motor op afstand.

PT - Instalação com motor remoto.

DK - Installation med fjernmotor.

SE - Installation med separat monterad motor.

FI - Asennus etäkäyttömootorilla.

NO - Installasjon med fjernmotor.

pag. | page
Seite | стр.
str. | side
sivu

20

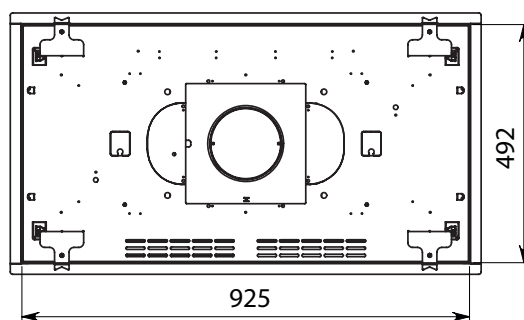
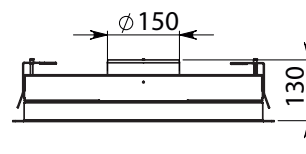
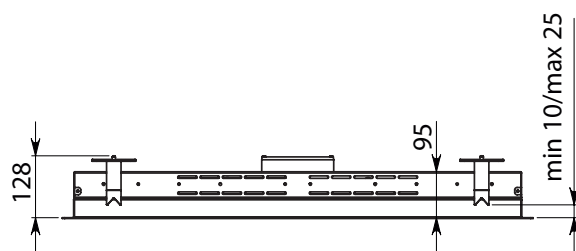
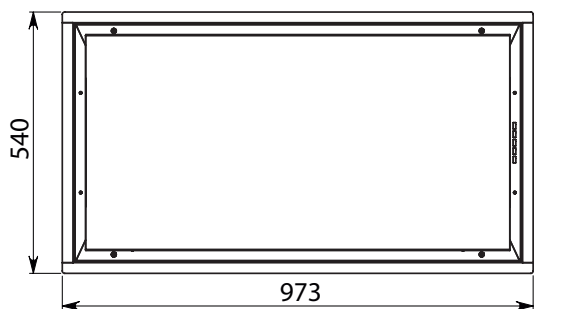
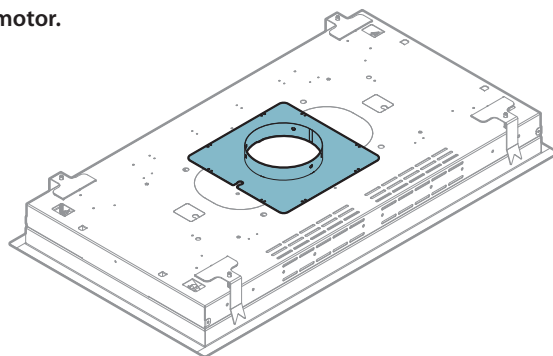

NUBE: 22 KG

DIMENSIONE FORATURA
HOLE SIZES

