

SAMSUNG

USER GUIDE

HW-Q990H / HW-Q930H

HW-Q900H / HW-Q800H

HW-Q600H

To receive more complete service, please register your product at www.samsung.com

Figures and illustrations in this User Manual are provided for reference only and may differ from actual product appearance.

Contents

01 Safety Information	3	06 Connecting to a TV	15
SAFETY WARNINGS	3	Connect to a TV that supports HDMI ARC (Audio Return Channel)	15
Important Safety Instructions	3	Connecting Using an Optical Cable	16
Precautions	4	Connecting by Bluetooth	16
02 Checking the Components	4	Connecting by Wi-Fi (Wireless Network)	17
03 Product Overview	5	Using the Q-Symphony Feature	18
Top side	5	Using SpaceFit Sound Pro	18
Bottom side	6	07 Connecting an External Device	19
04 Using the Remote Control	6	Connecting by HDMI Cable	19
How to use the Remote Control	6	Connecting using an Optical Cable	19
Setting the  (Sound Control)	8	08 Connecting a Mobile Device	20
Output specifications for each sound mode	8	Connecting by Bluetooth	20
- Using the subwoofer only	8	Connecting by Wi-Fi (Wireless Network)	21
- Using the subwoofer and surround speaker together ...	9	Using Group Play	21
- Using the subwoofer and rear speaker (SWA-9500S, optional) together	9	Connecting to Apple AirPlay®	22
Adjusting the Soundbar Volume with the TV Remote Control	10	09 Installing the Soundbar on a Wall	22
05 Connecting the Soundbar to Other Units	10	Precautions when installing	22
Connecting the Power and Devices	10	Wall Mount Components	22
- Manually Connecting the Subwoofer and Surround Speakers	11	Installing the Surround Speakers on a Wall	24
- Status of rear indicator in subwoofer and surround speakers	12	10 Installing the Soundbar on top of the TV Stand	24
Speaker layout guide	13	Parts	24
- Recommended speaker layout	13	11 Software Update	25
- Recommended speaker layout in Surround Speaker mode	14	Automatic update	25
		USB update	25
		Security updates information	25
		Reset	25
		12 Troubleshooting	26
		13 Licenses & Other Information	28

01 Safety Information









The following also applies to the Subwoofer and Surround Speaker SET.

SAFETY WARNINGS

TO REDUCE THE RISK OF ELECTRIC SHOCK, DO NOT REMOVE THE COVER (OR BACK).

NO USER-SERVICEABLE PARTS ARE INSIDE. REFER SERVICING TO QUALIFIED SERVICE PERSONNEL.

Refer to the table below for an explanation of symbols which may be on your Samsung product.

	CAUTION RISK OF ELECTRIC SHOCK. DO NOT OPEN.	
	This symbol indicates that high voltage is present inside. It is dangerous to make any kind of contact with any internal part of this product.	
	This symbol indicates that this product has included important literature concerning operation and maintenance.	
	Class II product : This symbol indicates that a safety connection to electrical earth (ground) is not required. If this symbol is not present on a product with a power cord, the product MUST have a reliable connection to protective earth (ground).	
	AC voltage : Rated voltage marked with this symbol is AC voltage.	
	DC voltage : Rated voltage marked with this symbol is DC voltage.	
	Caution. Consult Instructions for use : This symbol instructs the user to consult the user manual for further safety related information.	

WARNING

- To reduce the risk of fire or electric shock, do not expose this appliance to rain or moisture.
- To prevent injury, this apparatus must be securely attached to the floor/wall in accordance with the installation instructions.
- This product contains chemicals known to the State of California to cause cancer and birth defects or other reproductive harm.
- Do not use liquid fumigators containing chemicals, such as mosquito repellent or air freshener, around the product. If steam comes in contact with the product surface or enters the product, it may cause stains or malfunction.
- For crevices or other areas that cannot be thoroughly cleaned with a cloth, use a soft cotton swab, brush, or air blower to remove dirt.

CAUTION

- Do not expose this apparatus to dripping or splashing. Do not put objects filled with liquids, such as vases, on the apparatus.
- To turn this apparatus off completely, you must pull the power plug out of the wall socket. Consequently, the power plug must be easily and readily accessible at all times.

Important Safety Instructions

Read these operating instructions carefully before using the unit. Follow all the safety instructions listed below. Keep these operating instructions handy for future reference.

1. Read these instructions.
2. Keep these Instructions.
3. Heed all warnings.
4. Follow all instructions.
5. Do not use this apparatus near water.
6. Clean only with dry cloth.
7. Do not block any ventilation openings.
Install in accordance with the manufacturer's instructions.
8. Do not install near any heat sources such as radiators, heat registers, stoves, or other apparatus (including amplifiers) that produce heat.
9. Do not hinder in any way the safety purpose of the polarized or grounding-type plug.
A polarized plug has two blades with one wider than the other. A grounding type plug has two blades and a third grounding prong. The wide blade or the third prong are provided for your safety. If the provided plug does not fit into your outlet, consult an electrician for replacement of the obsolete outlet.
10. Protect the power cord from being walked on or pinched particularly at plugs, convenience receptacles, and the point where they exit from the apparatus.
11. Only use attachments/accessories specified by the manufacturer.
12. Use only with the cart, stand, tripod, bracket, or table specified by the manufacturer, or sold with the apparatus. When a cart is used, use caution when moving the cart/apparatus combination to avoid injury from tip-over.



13. Unplug this apparatus during lightning storms or when unused for long periods of time.
14. Refer all servicing to qualified service personnel. Servicing is required when the apparatus has been damaged in any way, such as power-supply cord or plug is damaged, liquid has been spilled or objects have fallen into the apparatus, the apparatus has been exposed to rain or moisture, does not operate normally, or has been dropped.

Precautions

1. Ensure that the AC power supply in your house complies with the power requirements listed on the identification sticker located on the bottom of your product. Install your product horizontally, on a suitable base (furniture), with enough space around it for ventilation (3~4 inches). Make sure the ventilation slots are not covered. Do not place the unit on amplifiers or other equipment which may become hot. This unit is designed for continuous use. To fully turn off the unit, disconnect the AC plug from the wall outlet. Unplug the unit if you intend to leave it unused for a long period of time.
2. During thunderstorms, disconnect the AC plug from the wall outlet. Voltage peaks due to lightning could damage the unit.
3. Do not expose the unit to direct sunlight or other heat sources. This could lead to overheating and cause the unit to malfunction.
4. Protect the product from moisture (i.e. vases), and excess heat (e.g. a fireplace) or equipment creating strong magnetic or electric fields. Unplug the power cable from the AC wall socket if the unit malfunctions. Your product is not intended for industrial use. It is for personal use only. Condensation may occur if your product has been stored in cold temperatures. If transporting the unit during the winter, wait approximately 2 hours until the unit has reached room temperature before using.
5. The battery used with this product contains chemicals that are harmful to the environment. Do not dispose of the battery in the general household trash. Do not expose the battery to excess heat, direct sunlight, or fire. Do not short circuit, disassemble, or overheat the battery.
CAUTION : Danger of explosion if the battery is replaced incorrectly. Replace only with the same or equivalent type.

02 Checking the Components

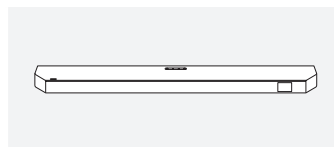

Soundbar

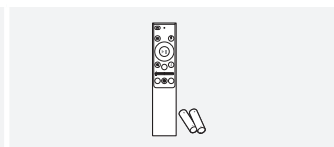

Remote Control (AH81-15047A)
/ Battery (Not available in some regions)



Subwoofer



Surround speaker x2
(Left / Right)
(HW-Q990H / Q930H)

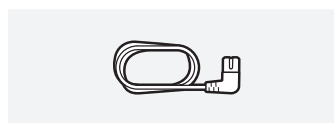

Power cable x4
(HW-Q990H / Q930H)
(Soundbar, Subwoofer)
(3903-001117)
(Surround speaker)
(3903-001295)

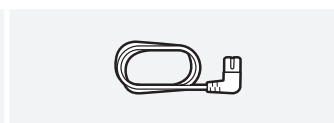

Power cable x2
(HW-Q900H / Q800H / Q600H)
(Soundbar, Subwoofer)
(3903-001117)

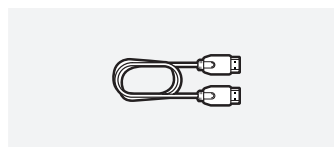

HDMI Cable
(HW-Q990H / HW-Q900H :
AH81-17772A)
(HW-Q930H / HW-Q800H /
HW-Q600H : BN39-02661A)

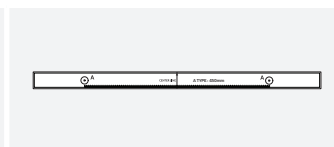

Wall-mounting Guide



Holder-Screw x2
(AH61-04110A)



Screw (M4 x L10) x2
(6001-001202)



Wall-mounting Bracket x2
(AH61-04119A)



Rubber Foot x4
(BN67-00398L)

- Some components may differ by model and region, and may not be provided. (e.g., HDMI cable, batteries, etc.)
- For more information on power supply and power consumption, refer to the label attached on the bottom or back of the product.
- To purchase additional components or optional cables, contact a Samsung Service Center or Samsung Customer Care.
- HDMI cable may not be provided in some regions.
- For more details about the wall mount and rubber foot, see the "[Installing the Soundbar on a Wall!](#)" section.
- To enhance the product, product design, specifications, and app interface may change without prior notice.
- The color and shape of parts may vary from what is depicted.

03 Product Overview

Top side

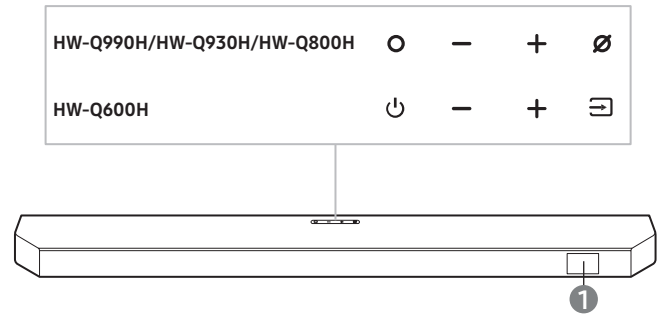

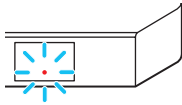
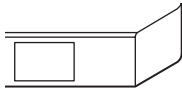
○	<p>(Multi) Button</p> <ul style="list-style-type: none"> • In Standby mode, you can turn on the soundbar by pressing the ○ (Multi) button. • You can switch the source by pressing the ○ (Multi) button.
- +	<p>(Volume) Button</p> <p>Adjusts the volume.</p>
∅	<p>(Microphone) Button</p> <ul style="list-style-type: none"> • Press the button to turn the microphone on or off. When the microphone is off, the LED indicator will turn red. <div style="display: flex; justify-content: space-around;"> <div style="text-align: center;"> <p>Microphone off: red indicator on</p>  </div> <div style="text-align: center;"> <p>Microphone on: red indicator off</p>  </div> </div> <ul style="list-style-type: none"> • Press and hold the ∅ (Microphone) button at the top of the soundbar for 3 seconds or longer to switch to BT PAIRING mode.
⏻	<p>(Power) Button</p> <p>Turn the power on or off.</p>
➡	<p>(Source) Button</p> <ul style="list-style-type: none"> • You can switch the source by pressing the ➡ (Source) button. • To put the Bluetooth into pairing mode, press and hold the ➡ (Source) button on the soundbar for 3 seconds or longer.
①	<p>Display</p> <p>Shows the status or current mode.</p> <p>TV ARC or eARC → HDMI or HDMI 1/HDMI 2 → Wi-Fi → BT → D.IN</p>

- When you turn on the soundbar, it may take 4 to 5 seconds for the sound to start.
- If audio plays from both the TV and soundbar, open the TV's **Audio Settings** menu, then select **External Speaker** instead of TV Speaker.

Bottom side

[HW-Q990H / HW-Q900H]

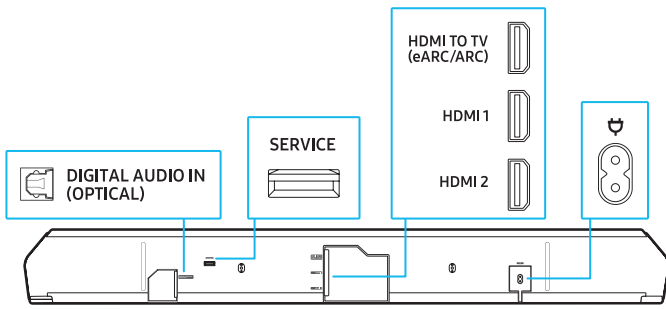

[HW-Q930H / HW-Q800H / HW-Q600H]

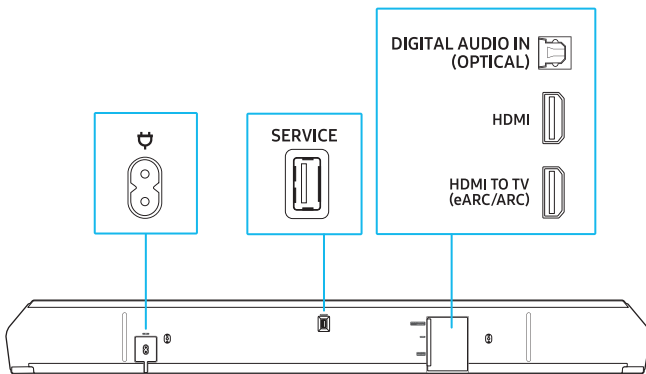

DIGITAL AUDIO IN (OPTICAL)	Connect to a digital (optical) output terminal of TV or external devices. (See the " Connecting using an Optical Cable " section.)
SERVICE	Use this port to update firmware through USB.
HDMI TO TV (eARC/ARC)	Use this HDMI port to connect to a TV. (See the " Connect to a TV that supports HDMI ARC (Audio Return Channel) " section.)
HDMI or HDMI1/HDMI2	This port is used for connecting an HDMI cable to transmit digital video and audio simultaneously. Connect to an HDMI output of external devices. (See the " Connecting by HDMI Cable " section.)
	Connect the power cable to this power port. (See the " Connecting the Power and Devices " section.)

04 Using the Remote Control

How to use the Remote Control

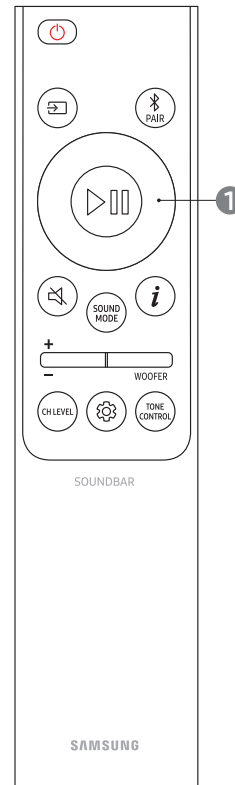





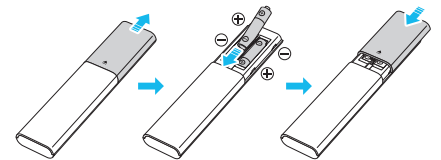









Install Batteries (AAA battery X 2)

Slide the battery cover in the direction of the arrow until it is fully removed. After inserting the batteries (1.5V, AAA) in the correct direction, slide the back cover onto the remote control in the direction of the arrow.

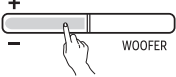

 (POWER)	<p>Turns the soundbar on or off.</p> <p>The soundbar will automatically turn off in the following situations. (Power saving mode)</p> <ul style="list-style-type: none"> TV ARC, HDMI or HDMI1/HDMI 2, Wi-Fi, BT, D. IN Mode: No audio signal input for 18 minutes or longer
 (Source)	<ul style="list-style-type: none"> You can choose the device connected to the soundbar. Turn voice feedback on or off. You can turn voice feedback on or off. With the soundbar turned off (in Standby mode), press and hold the (Source) button on the remote control for 5 seconds. Whenever you change the voice feedback settings, the display will show "AUI OFF" (default) or "AUI ON".
 (Bluetooth connection)	<p>Puts the soundbar into the Bluetooth pairing mode. When you press the button, "BT PAIRING" will appear on the display and you can connect a new Bluetooth device.</p>

 (Up / Down / Left / Right)	<p>Use the Up/Down/Left/Right buttons to make fine adjustments.</p> <ul style="list-style-type: none"> • Skip a song Press the Right button to skip to the next song. Press the Left button to go to the previous song. • ID SET Use this option if the subwoofer or surround speakers aren't connected and need to be reconnected. While powered off, press and hold the Up button for 5 seconds to perform ID SET. (See the "Manually Connecting the Subwoofer and Surround Speakers" section.)
 (Play/Pause)	<p>Starts or pauses playback.</p>
 (Mute)	<p>To mute the soundbar, press the  (Mute) button. Press it again to unmute.</p>
 (Sound mode)	<p>Select the desired sound mode among Surround, Game Pro, Standard, or Adaptive Sound.</p> <ul style="list-style-type: none"> • Standard The original sound will be played back. • Surround Surround sound will be activated. • Game Pro This mode is optimized for gaming, providing a more immersive sound experience. • Adaptive Sound In this mode, content is analyzed in real time and optimal sound is played based on the type of content.
 (Info)	<p>Press this button to view the codec information or the current status. In BT mode, the connected device (Paired) or BT READY (Need Pairing) will be displayed.</p>
 (Woofer (bass) Level)	 <p>You can adjust the woofer (bass) levels by sliding the button up or down.</p>
 (Volume)	 <p>Press the Up or Down button to adjust the volume.</p>  <ul style="list-style-type: none"> • (Mute) Press the Volume button. Press it again to unmute.
 (Channel level)	<p>You can adjust the volume of each speaker including the Center level, Side level, Wide level, Front Top level, Rear level, Rear top level and Rear side level.</p> <ul style="list-style-type: none"> • To adjust the volume of each speaker, select Center level, Side level, Wide level, or Front Top level in the audio settings, then use the Up/Down buttons to adjust the volume within the range of -6 to +6. • When the surround speakers are connected, select Rear level, Rear top level or Rear side level and then use the Up/Down buttons to adjust the volume within the range of -6 to +6.

 (Sound Control)	<p>You can select audio features such as SpaceFit Sound Pro, AVA Pro, Sound Elevation, Auto Volume, Voice Enhancement, Night mode, Sync, Surround Speaker, Sound Grouping, Private Rear, Moderate Bass, Virtual.</p> <p>To adjust a sound setting, press the Up or Down button to select your desired option.</p> <ul style="list-style-type: none"> • See the "Setting the  (Sound Control)" section.
 (Tone control)	<p>Adjust the treble and bass levels by pressing the respective buttons. After selecting an option, use the Up/Down buttons to adjust the settings.</p> <ul style="list-style-type: none"> • This feature is available in all sound modes except the Standard mode. • Adjust the treble or bass levels by selecting TREBLE or BASS in the Sound Control. Then, use the Up/Down buttons to adjust the volume level within the range of -6 to +6. • When adjusting the bass levels, the woofer levels will also be affected.

Setting the (Sound Control)

SpaceFit Sound Pro, AVA (Active Voice Amplifier) Pro, and Surround Speaker features are not supported on the HW-Q600H model.

- **SpaceFit Sound Pro:** This feature analyzes your listening space using the soundbar's microphone to deliver optimal audio quality. Sound optimization runs automatically. (For more details, refer to the "Using SpaceFit Sound Pro" section.)
- **AVA (Active Voice Amplifier) Pro:** This feature analyzes external noise to ensure clear voice quality. No data is collected or stored during analysis.
- **Sound Elevation:** When the soundbar is placed below the TV, this feature compensates for the mismatch between the sound output position and the visual position on the screen.
 - When this feature is set to **ON**, you can experience the effect of the sound coming directly from the TV screen.
 - This feature is available only when **Sound Grouping** or **Private Rear** is set to **OFF**.
 - If **Sound Grouping** or **Private Rear** is set to **ON**, this feature cannot be used, and "Not Available" will appear on the soundbar's display.
- **Auto Volume:** This feature automatically adjusts the volume to maintain a consistent level when changing content or switching to another external input.
 - This function is available only when **Q-Symphony** is set to **OFF**.
 - If **Q-Symphony** is set to **ON**, this function cannot be used, and "Not Available" will appear on the soundbar's display.
- **Voice Enhancement:** Improves the dialogue quality in videos and TV shows, making it easier to hear.
- **Night mode:** Optimizes the listening experience at night by lowering the volume while keeping spoken dialog clear.
- **Sound Grouping:** The full sound is played through both the soundbar and rear speakers, making it ideal for a group of people in a large space.
 - When the rear speakers are connected for the first time, the Sound Grouping menu will be available. After that, the menu will remain available, regardless of whether the rear speakers are connected.
 - In **Sound Grouping** mode, sound modes won't affect the audio.
 - Sound will only come from specific speakers, not from the soundbar and all rear speakers. This may vary by model.
- **Private Rear:** This feature allows you to send audio to only the rear speakers, so you can listen without being disturbed.
 - In this mode, no sound will come from the soundbar or subwoofer. Only the front channels of the rear speakers will produce sound.
 - In **Private Rear** mode, sound modes won't affect the audio.
 - When the soundbar is turned off or the connection to the rear speakers is lost, the mode will turn off.
 - The **Private Rear** will only be available when a rear speaker is connected.
 - When connecting **Q-Symphony**, the **Private Rear** mode will automatically turn off and can't be turned back on.
- **Sync:** If the video and audio are out of sync when played through the TV and soundbar, go to the **Sound Control** and select **Sync**. Then, use the **Up/Down** buttons to adjust the audio delay between 0 and 300 milliseconds.
 - **Sync** is supported only in certain functions.
- **Surround Speaker** settings may vary, depending on the specifications of the compatible surround speakers (including soundbars).
- **Virtual** : While **Surround** mode is on, it provides extended sound effects when playing Dolby/DTS content. This feature can be turned On/Off by using the **Up/Down** buttons.

- **Moderate Bass:** When turned **ON**, the subwoofer is muted and bass will be output through the soundbar. When turned **OFF**, the subwoofer is turned on, and no bass will be output through the soundbar.
- To adjust the sound of each frequency, press and hold the  (**Sound Control**) button for about 5 seconds. You can select 150Hz, 300Hz, 600Hz, 1.2kHz, 2.5kHz, 5kHz, or 10kHz with the **Left/Right** buttons, and make adjustments within the range of -6 to +6 using the **Up/Down** buttons. (This feature only works when the sound mode is set to **Standard**.)

Output specifications for each sound mode

DTS:X may not be supported depending on the model or region.

Using the subwoofer only

[HW-Q900H]

Effect	Input	Output
Standard	2.0 Channel	2.1 Channel
	5.1 Channel	5.1 Channel
	7.1 Channel	7.1 Channel
	Dolby Atmos®	7.1.2 Channel
Surround Game Pro Adaptive Sound	2.0 Channel	7.1.2 Channel
	5.1 Channel	7.1.2 Channel
	7.1 Channel	7.1.2 Channel
	Dolby Atmos®	7.1.2 Channel

[HW-Q800H]

Effect	Input	Output
Standard	2.0 Channel	2.1 Channel
	5.1 Channel	5.1 Channel
	7.1 Channel	5.1 Channel
	Dolby Atmos®	5.1.2 Channel
Surround Game Pro Adaptive Sound	2.0 Channel	5.1.2 Channel
	5.1 Channel	5.1.2 Channel
	7.1 Channel	5.1.2 Channel
	Dolby Atmos®	5.1.2 Channel

[HW-Q600H]

Effect	Input	Output
Standard	2.0 Channel	2.1 Channel
	5.1 Channel	3.1 Channel
	7.1 Channel	3.1 Channel
	Dolby Atmos®	3.1.2 Channel
Surround Game Pro Adaptive Sound	2.0 Channel	3.1.2 Channel
	5.1 Channel	3.1.2 Channel
	7.1 Channel	3.1.2 Channel
	Dolby Atmos®	3.1.2 Channel

Using the subwoofer and surround speaker together

[HW-Q990H]

Effect	Input	Output
Standard	2.0 Channel	2.1 Channel
	5.1 Channel	5.1 Channel
	7.1 Channel	7.1 Channel
	Dolby Atmos®, DTS:X	7.1.4 Channel
Surround Game Pro Adaptive Sound	2.0 Channel	11.1.4 Channel
	5.1 Channel	11.1.4 Channel
	7.1 Channel	11.1.4 Channel
	Dolby Atmos®, DTS:X	11.1.4 Channel

[HW-Q930H]

Effect	Input	Output
Standard	2.0 Channel	2.1 Channel
	5.1 Channel	5.1 Channel
	7.1 Channel	7.1 Channel
	Dolby Atmos®	7.1.4 Channel
Surround Game Pro Adaptive Sound	2.0 Channel	9.1.4 Channel
	5.1 Channel	9.1.4 Channel
	7.1 Channel	9.1.4 Channel
	Dolby Atmos®	9.1.4 Channel

Using the subwoofer and rear speaker (SWA-9500S, optional) together

[HW-Q900H]

Effect	Input	Output
Standard	2.0 Channel	2.1 Channel
	5.1 Channel	5.1 Channel
	7.1 Channel	7.1 Channel
	Dolby Atmos®	7.1.4 Channel
Surround Game Pro Adaptive Sound	2.0 Channel	9.1.4 Channel
	5.1 Channel	9.1.4 Channel
	7.1 Channel	9.1.4 Channel
	Dolby Atmos®	9.1.4 Channel

[HW-Q800H]

Effect	Input	Output
Standard	2.0 Channel	2.1 Channel
	5.1 Channel	5.1 Channel
	7.1 Channel	7.1 Channel
	Dolby Atmos®	7.1.4 Channel
Surround Game Pro Adaptive Sound	2.0 Channel	7.1.4 Channel
	5.1 Channel	7.1.4 Channel
	7.1 Channel	7.1.4 Channel
	Dolby Atmos®	7.1.4 Channel

[HW-Q600H]

Effect	Input	Output
Standard	2.0 Channel	2.1 Channel
	5.1 Channel	5.1 Channel
	7.1 Channel	5.1 Channel
	Dolby Atmos®	5.1.4 Channel
Surround Game Pro Adaptive Sound	2.0 Channel	5.1.4 Channel
	5.1 Channel	5.1.4 Channel
	7.1 Channel	5.1.4 Channel
	Dolby Atmos®	5.1.4 Channel





The surround speakers won't produce sound for 2-channel output while the **Standard** effect mode is active. To turn on sound for the surround speakers, change the effect mode to **Surround**.

Adjusting the Soundbar Volume with the TV Remote Control

This feature allows you to adjust the soundbar volume using the TV's remote control.

- This function can only be used with an IR remote control. Bluetooth remote controls (those that need pairing) aren't supported.
- Set the TV speaker to **External Speaker** to use this function.
- Manufacturers that support this feature: Samsung, VIZIO, LG, Sony, Sharp, PHILIPS, PANASONIC, TOSHIBA, Hisense, RCA

1. Turn off the soundbar.
2. Push the **WOOFER** button up and hold for 5 seconds. When you press and hold the **WOOFER** button for up to 5 seconds, the mode will change in the following sequence: **OFF-TV REMOTE** (default), **SAMSUNG-TV REMOTE**, and then **ALL-TV REMOTE**.

Remote control button	Display	Status
 <p>5 seconds</p>	 <p>(Default) OFF-TV REMOTE</p>	Disables the TV remote control.
 <p>5 seconds</p>	SAMSUNG-TV REMOTE	Controls the soundbar with a Samsung TV IR remote control.
 <p>5 seconds</p>	ALL-TV REMOTE	Controls the soundbar with a different TV manufacturer's IR remote control.

05 Connecting the Soundbar to Other Units

Connecting the Power and Devices

Using the power cords, connect the subwoofer, surround speakers, and soundbar to an electrical outlet in the following order:

- For more information on power supply and power consumption, refer to the label attached on the bottom or back of the product.
- Always grip the plug firmly and pull it directly when disconnecting the power cord from the wall outlet. Do not pull on the power cord itself.
- Once all devices are connected, connect the soundbar and other devices to an electrical power outlet.
- Surround speakers may not be included, depending on the product model.

1. Connect the power cord to the subwoofer.

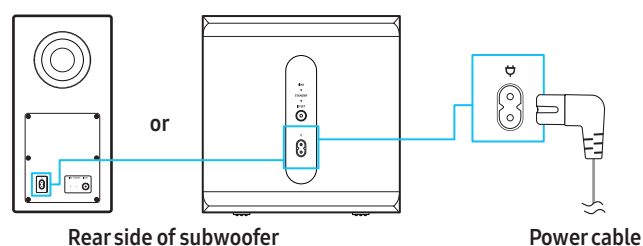

2. Connect the power cords to the left and right surround speakers.
 - Surround speaker may not be included with certain models.

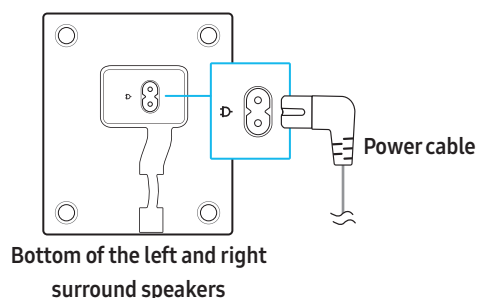

3. Connect the power cord to the soundbar.

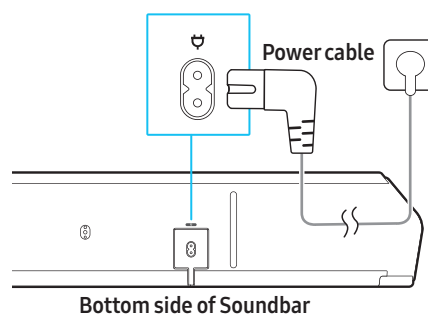

4. Connect the soundbar, subwoofer, and surround speakers to a power outlet. When the soundbar is turned on, the subwoofer and surround speakers will automatically connect to it.

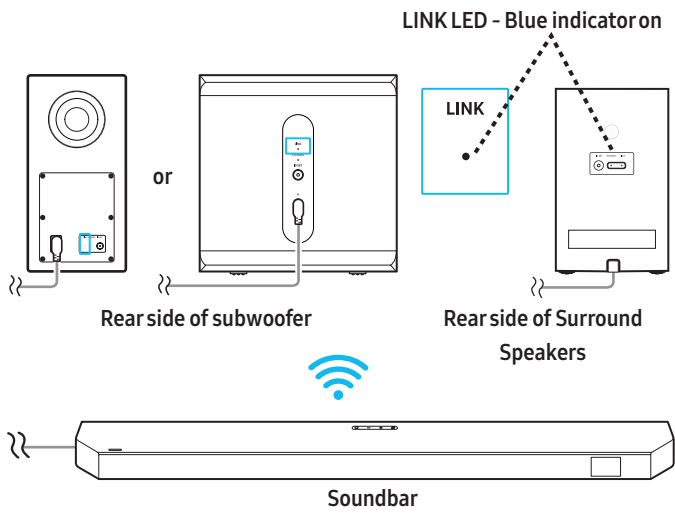

NOTE

- First, connect the subwoofer and surround speakers to a power outlet, then turn on the soundbar once it is plugged in. When the soundbar is powered on, the subwoofer and surround speakers will automatically connect.
- If you disconnect the power cord while the soundbar is on, and reconnect it to a power outlet, the soundbar will automatically turn on.

Manually Connecting the Subwoofer and Surround Speakers

Before manually connecting the speaker units

- Make sure the soundbar, subwoofer, and surround speakers are connected to a power outlet.
- Make sure the soundbar is turned off.
- Surround speaker may not be included with certain models.

1. Press and hold **ID SET** button on the rear side of the subwoofer and surround speakers for 5 seconds or longer.
 - The red indicator on the rear of each speaker will turn off, and the blue indicator will blink rapidly.

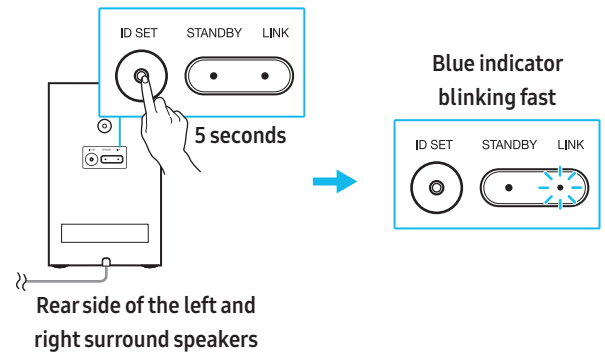
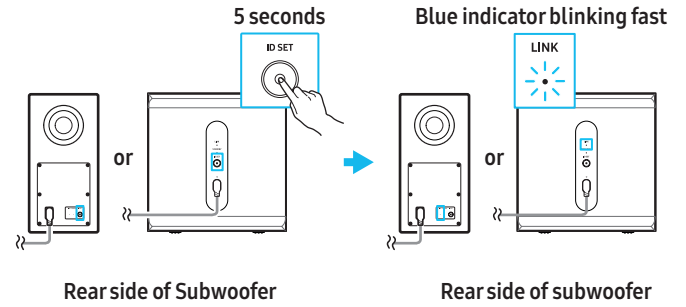

2. Press and hold the **Up** button on the remote control for 5 seconds.
 - The **ID SET** message briefly appears on the soundbar display and then disappears.
 - After the **ID SET** message, the soundbar will automatically power on.

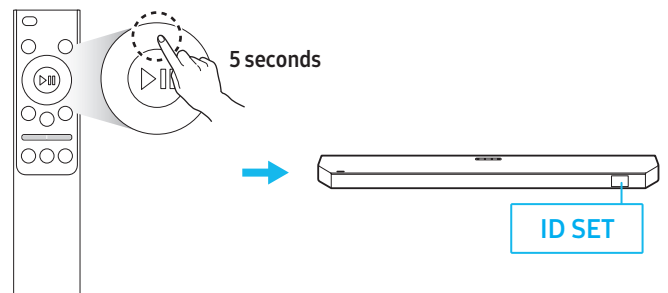

3. Make sure the **LINK** LED indicator turns blue (indicating a successful connection).

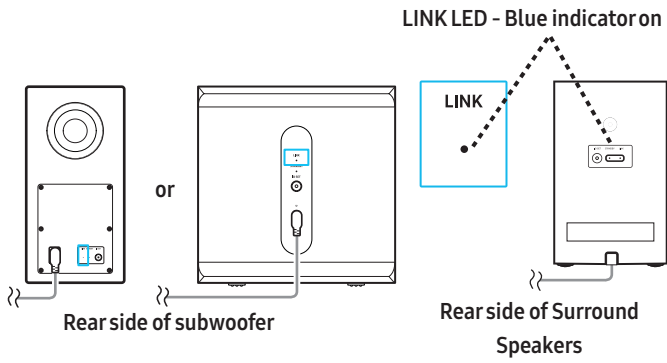

When the soundbar is properly connected to the subwoofer and surround speakers, the **LINK** LED indicator will stop blinking and turn solid blue.

NOTE

- Surround speakers may not be included, depending on the product model.
- How to reset the Tx module
 - 1) Turn off the soundbar.
 - 2) Press and hold the **Left** button on the remote control for 5 seconds.
 - 3) Follow the instructions in the [Manually Connecting the Subwoofer and Surround Speakers](#) section.

Status of rear indicator in subwoofer and surround speakers

LED	Status	Troubleshooting
<p>Subwoofer</p> <p>or</p> <p>(Blue indicator on)</p> <p>Surround speaker</p> <p>(Blue indicator blinking)</p>	<p>Connection successful (normal operation)</p> <p>Restore connection</p>	<p>-</p> <p>Check if the soundbar's power cable is securely connected or wait for about 5 minutes. If the blinking continues, manually connect the subwoofer and surround speakers. See the "Manually Connecting the Subwoofer and Surround Speakers" section.</p>
<p>Subwoofer</p> <p>or</p> <p>(Red indicator on)</p> <p>Surround speaker</p> <p>(Red indicator on)</p>	<p>In standby (with soundbar turned off)</p> <p>Connection unsuccessful</p>	<p>Check if the soundbar's power cable is securely connected.</p> <p>Try reconnecting. Refer to the "Manually Connecting the Subwoofer and Surround Speakers" section.</p>
<p>Subwoofer</p> <p>or</p> <p>(Red and blue indicator blinking simultaneously)</p> <p>Surround speaker</p> <p>(Red and blue indicator blinking simultaneously)</p>	<p>Product malfunction</p>	<p>See the contact information for the Samsung Service Center in this manual.</p>

NOTE

- When the soundbar is turned off, the subwoofer will enter **Standby** mode. The **STANDBY** indicator on the rear of the unit will rapidly blink blue and then turn red.
- If there is a nearby device using the same frequency as the soundbar, interference may occur, causing the sound output to be interrupted.
- The wireless signal from the soundbar can be transmitted up to 10 meters under normal installation conditions, but this distance may vary, depending on the operating environment. If there is a steel wall or reinforced concrete between the soundbar and the subwoofer or surround speakers, the wireless signal will be blocked, preventing the product from functioning properly.
- Surround speakers may not be included, depending on the product model.

⚠ CAUTION

- A wireless antenna is built into the subwoofer and surround speakers. Keep away from water and moisture.
- For optimal sound quality, avoid placing obstacles around the subwoofer or surround speakers.
- Do not insert any part of the body or foreign objects into the subwoofer duct.
- Do not use the subwoofer duct as a mounting point or hang the subwoofer on a wall by the duct.

Speaker layout guide

Recommended speaker layout

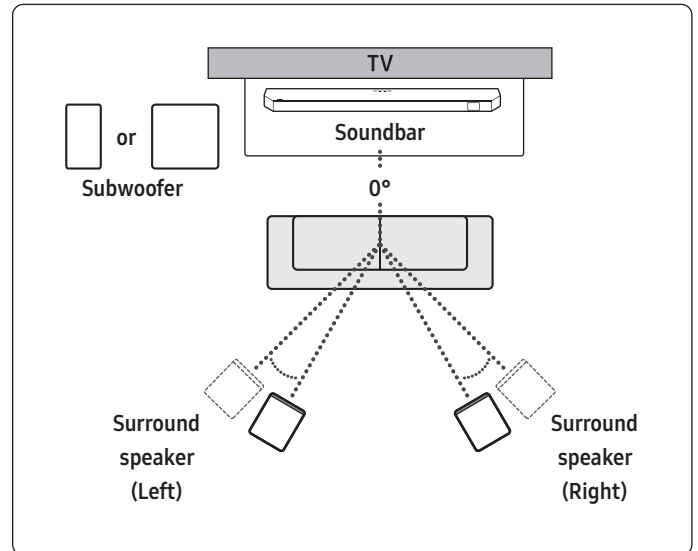

⚠ CAUTION

- A wireless antenna is built into the subwoofer and surround speakers. Keep away from water and moisture.
- For optimal sound quality, avoid placing obstacles around the subwoofer or surround speakers.
- Surround speakers may not be included, depending on the product model.

Recommended speaker layout in Surround Speaker mode

Adjust the surround speakers to position them effectively for optimal surround sound. Please arrange the units as shown in the diagram below.

To turn on this mode, select **Surround Speaker** mode on your soundbar remote control.

( (Sound Control) → **Surround Speaker** → ▲ (Up) / ▼ (Down) → **Front / Rear**)

Rear layout

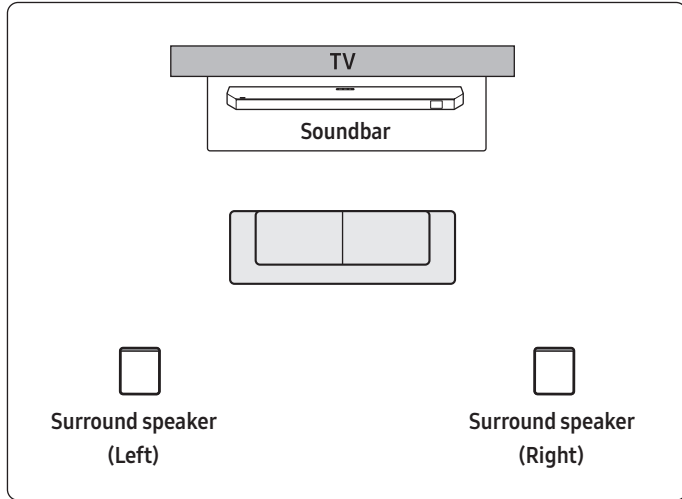

Front layout (HW-Q990H)

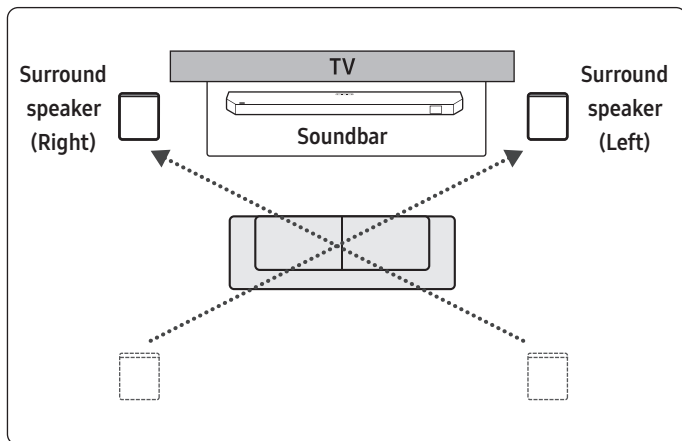

Front layout (HW-Q930H)

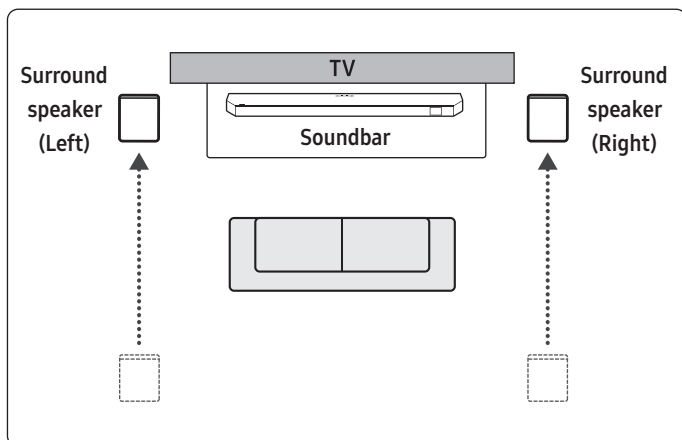

NOTE

- This feature only works with soundbars that are included with specific surround speakers.
- In **Front** mode, position the front speakers so that they face the listener.
- By default, the rear layout is set for the **Surround Speaker** mode.
- Surround speakers may not be included, depending on the product model.

06 Connecting to a TV

Connect to a TV that supports HDMI ARC (Audio Return Channel)

⚠ CAUTION

- If both an HDMI cable and an optical cable are connected, the HDMI cable signal will take priority.
- When connecting the TV and soundbar with an HDMI cable, make sure to connect the cable to the ARC port. If the correct port isn't used, the TV won't make any sound.
- Using HDMI cables certified by HDMI.org is recommended.

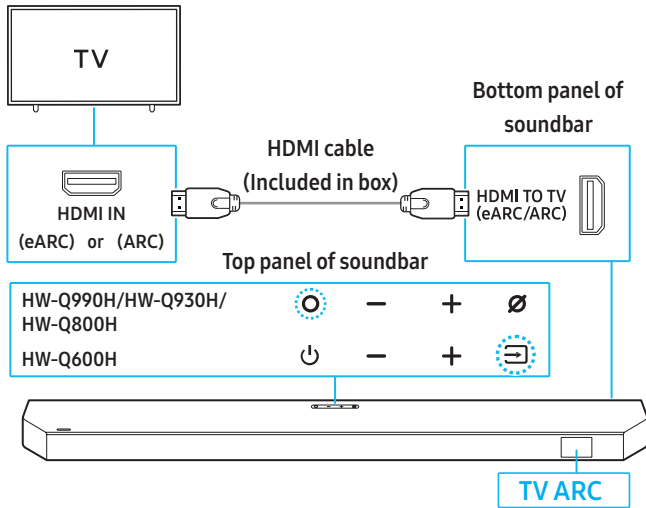

1. While the soundbar and TV are turned off, connect the HDMI cable as shown in the diagram above.
2. Turn on the soundbar and TV.
3. "TV ARC" will appear on the soundbar display, and the TV audio will play through the soundbar.
 - If there is no TV sound output, press the **○ (Multi)** button or **→ (Source)** button at the top of the soundbar or press the **→ (Source)** button on the remote control to switch to **TV ARC** mode. "TV ARC" will be displayed and the TV audio will sound.
 - When connected to a TV that supports the eARC feature, "TV eARC" will be displayed and audio will sound.
 - To connect with eARC, the eARC function in the TV menu should be turned on. Refer to the TV user manual for details about how to configure the settings.
(e.g.) Samsung TV: Home (🏠) → Settings (⚙️) → All Settings (⚙️) → Sound → Expert Settings → HDMI-eARC Mode (Auto)
 - If "TV ARC" doesn't appear on the soundbar display, check if the HDMI cable is securely connected to the correct port.
 - You can use the volume buttons on your TV remote control to adjust the soundbar volume.

NOTE

- When connecting a TV and soundbar that support HDMI ARC (Audio Return Channel) using an HDMI cable, digital video and audio data can be transmitted without a separate optical cable.
- Using a coreless HDMI cable is recommended whenever possible. If using a cored HDMI cable, ensure its diameter is less than 14 mm.
- This function won't work if the HDMI cable doesn't support ARC.
- If the broadcast audio is encoded in Dolby and the "Digital Output Audio Format" in your TV is set to PCM, changing the settings to Dolby Digital, Dolby Digital+, or Auto is recommended for optimal sound.
Changing the setting will provide better sound quality. (The TV menu may use different terms for Dolby Digital and PCM, depending on the manufacturer.)
- ARC/eARC protocol supports Dolby Atmos®.
- Check if the content you want for more information about Dolby Atmos® support.

Connecting Using an Optical Cable

Pre-connection Checklist

- If both an HDMI cable and an optical cable are connected, the HDMI cable signal will take priority.
- When using an optical cable, make sure to remove the cap from the optical cable before use.

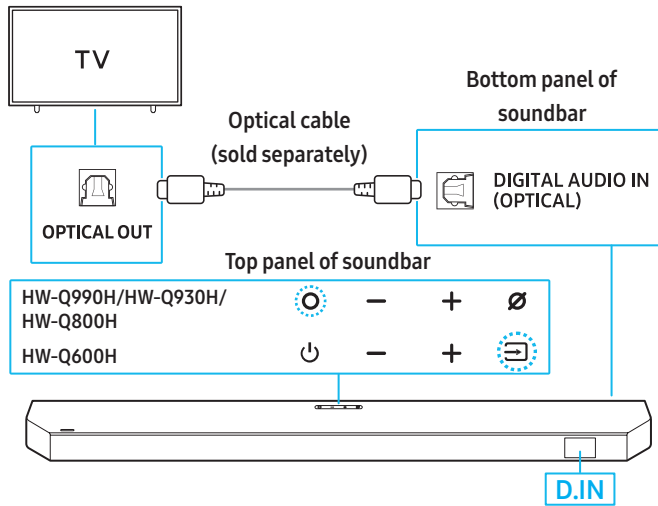

1. While the TV and soundbar are turned off, connect the **DIGITAL AUDIO IN (OPTICAL)** on the soundbar to the OPTICAL OUT port on the external device using an optical cable (sold separately), as shown in the above diagram.
2. Turn on the soundbar and TV.
3. Press the **Multi** button or **Source** button at the top of the soundbar or press the **Source** button on the remote control to switch to **D.IN** mode.
4. TV sound will play through the soundbar.

Connecting by Bluetooth

Connecting your Samsung TV to the soundbar by Bluetooth allows you to enjoy stereo sound without the need for cables.

- Only one Samsung TV can be connected by Bluetooth at a time.
- You can connect to a Samsung TV with Bluetooth support. Make sure to check your TV's specifications.

Connecting to Bluetooth for the first time

1. Press the **Pair** button on the Remote Control to open **BT PAIRING** mode.

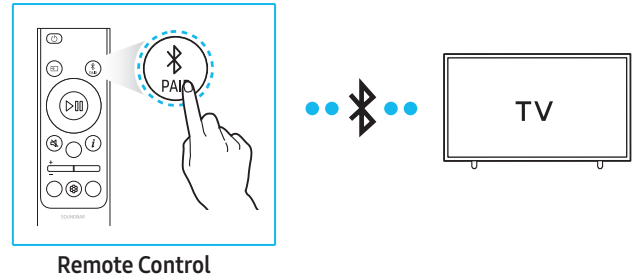

(Or)

Press the **Microphone** button or **Source** button at the top of the soundbar for 3 seconds or longer until "**BT PAIRING**" is displayed.

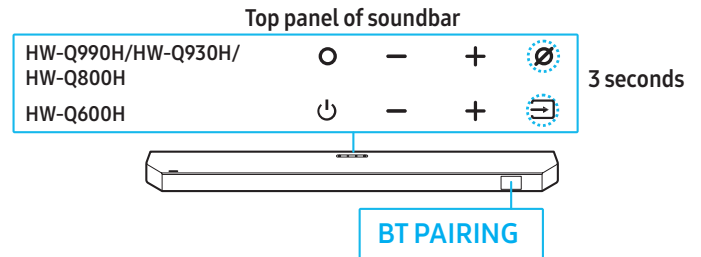

2. Open the Bluetooth menu on the Samsung TV you want to connect. (Examples: Home (🏠) → Settings (⚙️) → All Settings (⚙️) → Sound → Sound Output → Bluetooth Speaker List → Q-Series Soundbar (Bluetooth))
3. Select "**Q-Series Soundbar**" from the list on the TV screen. On the Samsung TV Bluetooth device list, "**Need Pairing**" or "**Paired**" will appear for a device. Select an option to establish a connection.
 - When the Samsung TV and soundbar are connected, **[TV name]** → "**BT**" will appear on the soundbar's front panel display.
4. You can now enjoy Samsung TV audio through the soundbar.
 - Once you have successfully connected the soundbar to your Samsung TV by Bluetooth, you can use the **BT READY** mode to reconnect.

If the Device Fails to Connect

- When a previously connected soundbar (e.g., **Q-Series Soundbar**) appears in the speaker list, delete it.
- Repeat steps 1 through 3.

Disconnecting the Soundbar from the Samsung TV

Press the **○ (Multi)** button or **↔ (Source)** button at the top of the soundbar or **↔ (Source)** button on the remote control and switch to any other mode besides **BT**.

- Ending the connection may take a few seconds as the TV waits for a response from the soundbar.
(The disconnection time may vary, depending on the Samsung TV model.)

What is the difference between BT READY and BT PAIRING?

- **BT READY:** In this mode, you can connect a previously connected TV or mobile device with the soundbar.
- **BT PAIRING:** In this mode, you can connect a new device to the soundbar.
(Press the **✳ Pair** button on the Remote Control or press and hold the **🎧 (Microphone)** button or **↔ (Source)** button at the top of the soundbar for 3 seconds.)

Precautions when connecting to Bluetooth

- Position the device you are connecting to the soundbar by Bluetooth within 1 meter.
- If prompted for a PIN code when connecting to a Bluetooth device, enter <0000>.
- The soundbar will automatically turn off after 18 minutes of inactivity in Standby mode.
- The soundbar may have difficulty scanning for available Bluetooth devices or connecting properly under the following conditions:
 - If there are nearby electronic devices or equipment causing radio interference.
 - If multiple Bluetooth devices are simultaneously paired with the soundbar.
 - If the Bluetooth device is turned off, out of range, or experiencing a malfunction.
- Electronic devices may cause radio interference. Keep any device that generates electromagnetic waves away from the soundbar. (e.g., microwave oven, wireless LAN, etc.)
- Press and hold the **TONE CONTROL** button on the remote control for 30 seconds or longer to activate or deactivate the Bluetooth.
- **When you activate or deactivate the Bluetooth connectivity, the soundbar will automatically restart.**

Connecting by Wi-Fi (Wireless Network)

Pre-connection Checklist

- Wi-Fi connection is only available on a Samsung TV.
- Check if the **wireless router (Wi-Fi)** is turned on and the **TV is connected to the wireless router**.
- Connect the soundbar and TV to the same Wi-Fi network.
- If your wireless router (Wi-Fi) uses a DFS channel, you won't be able to connect the TV and soundbar by Wi-Fi. Contact your Internet Service Provider for more details.
- Check your TV's manual since the menu may vary, depending on the year of manufacture.
- Connect the soundbar to the wireless router first so that you can connect the soundbar and TV by Wi-Fi.

1. For more information on how to connect your soundbar to a Wi-Fi network, see the "[Connecting by Wi-Fi \(Wireless Network\)](#)" section.
2. On the TV Sound menu, change the input source to soundbar.
 - **For Samsung TVs released in 2017 or later**
Home (🏠) → Settings (⚙️) → All Settings (⚙️) → Sound → Sound Output → Q-Series Soundbar (Wi-Fi)

NOTE

- Wi-Fi Dolby Atmos connectivity is only available on some Samsung TVs and soundbars.
- Press and hold the **CH LEVEL** button on the remote control for 30 seconds or longer to activate or deactivate the Wi-Fi.
- **When you activate or deactivate the Wi-Fi connectivity, the soundbar will automatically restart.**

Using the Q-Symphony Feature

- If you connect the soundbar to a Samsung TV that supports Q-Symphony, sound will play from both the soundbar and TV at the same time. You can enjoy a richer, more immersive sound with the TV's surround sound.
- When the soundbar is connected to your TV, the **Q-Symphony** menu will appear.
(Settings (⚙️) → All Settings (⚙️) → Sound → Sound Output)

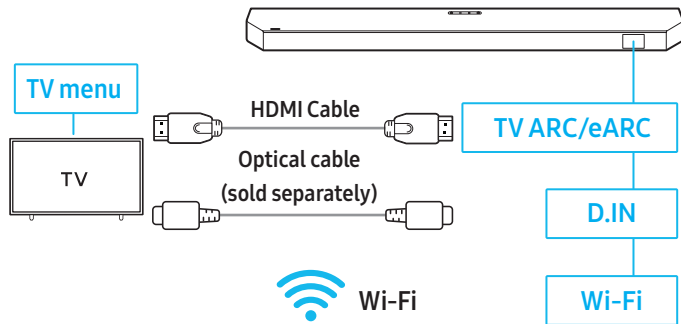

NOTE

- It will work with the codec supported by the TV.
- This feature is only supported when connected by HDMI cable, optical cable (sold separately), or Wi-Fi.
- The messages displayed on the TV may vary, depending on the model.
- Check and see if your soundbar and TV are connected to the same Wi-Fi network/frequency.
- This function is only available on some Samsung TVs and soundbars.

Using SpaceFit Sound Pro

This feature analyzes your listening space using the soundbar's microphone to deliver optimal audio quality. Sound optimization runs automatically.

Method 1. Connecting the Soundbar

To use this feature, turn on **SpaceFit Sound Pro** mode using the Remote Control.

1. ⚙️ Press the **(Sound Control)** button to turn on **SpaceFit Sound Pro** mode.
"SPACEFIT SOUND PRO OFF" will appear on the display.
 2. Turn on **SpaceFit Sound Pro** by pressing the **Up** button on the remote control.
"ON" will appear on the display.
 3. Turn off **SpaceFit Sound Pro** by pressing the **Down** button on the remote control.
"OFF" will appear on the display.
- It is available in all sound modes.

Method 2. Connecting to a TV

To use this feature, turn on Adaptive Sound+ mode in the Samsung TV menu.

(Home (🏠) → Settings (⚙️) → All Settings (⚙️) → General → AI Mode Settings → Adaptive Sound+)

- When you turn on **Adaptive Sound+** mode in the TV menu, the sound mode of the soundbar will change to **Adaptive Sound+** mode.

NOTE

- This feature works only on some Samsung TVs that are connected to a soundbar.
- The HW-Q600H model supports only the "[Connecting to a TV](#)" method.

07 Connecting an External Device

Connecting by HDMI Cable

Pre-connection Checklist

- If any secondary audio settings are on, turn them off in your audio output options.
- Check whether the content you are viewing supports Dolby Atmos®/DTS:X.
- Choose an HDMI cable that meets the required HDMI input/output specifications.
- To receive UHD signals, you must use a proper HDMI cable certified by HDMI.org.
 - HW-Q990H/Q900H : Ultra High Speed HDMI cable
 - HW-Q930H/Q800H/Q600H : Premium High Speed HDMI cable
- To receive UHD signals, check the video playback specifications of your TV and external device and also the settings of the device in use.
- Refer to your TV or external device manual for more details.

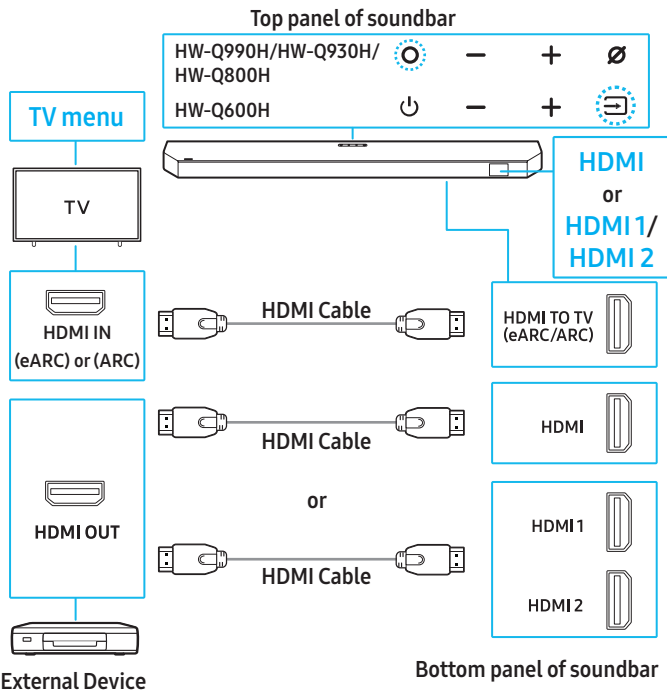

1. Use an HDMI cable to connect the HDMI OUT port on the external device to the HDMI port at the bottom of the soundbar.
2. Use an HDMI cable (included) to connect the HDMI IN port of the TV to the HDMI TO TV (eARC/ARC) port at the bottom of the soundbar.
3. Turn on the soundbar, TV, and external device.
4. Press the **Multi** button or **Source** button at the top of the soundbar or press the **Source** button on the remote control to switch to **HDMI** or **HDMI 1 / HDMI 2** mode.
5. The selected **HDMI** or **HDMI 1 / HDMI 2** mode will appear on the soundbar display panel and audio will play.

NOTE

- DTS:X may not be supported depending on the model or region.
- Using **Dolby Atmos®/DTS:X**: See the "[Output specifications for each sound mode](#)" section, if the inputted source is Dolby Atmos®/DTS:X.
- When Dolby Atmos® is active, "**DOLBY ATMOS**" will appear on the display.
- When DTS:X is active, "**DTS:X**" will appear on the display.
- **Configuring Dolby Atmos®/DTS:X on a BD player or other device**
Check the audio output options in the settings menu on the BD player or other device. "No Encoding" should be selected for bitstream in the audio output options.
Example) When using a Samsung BD Player: go to Home Menu → Sound → Digital Output and then select Bitstream (Unprocessed)

UHD signal support specifications (3840 x 2160p)

[HW-Q990H / HW-Q900H]

Frame rate (fps)	Color depth	RGB 4:4:4	YCbCr 4:4:4	YCbCr 4:2:2	YCbCr 4:2:0
< 60	8 bit	0	0	0	0
	10 bit	0	0	0	0
	12 bit	0	0	0	0
120	8 bit	0	0	0	0
	10 bit	0	0	0	0
	12 bit	-	-	0	0

[HW-Q930H / HW-Q800H]

Frame rate (fps)	Color depth	RGB 4:4:4	YCbCr 4:4:4	YCbCr 4:2:2	YCbCr 4:2:0
< 60	8 bit	0	0	0	0
	10 bit	-	-	0	0
	12 bit	-	-	-	-
120	8 bit	-	-	-	-
	10 bit	-	-	-	-
	12 bit	-	-	-	-

- Supported specifications may vary based on the external device connected to the soundbar or the usage conditions.

Connecting using an Optical Cable

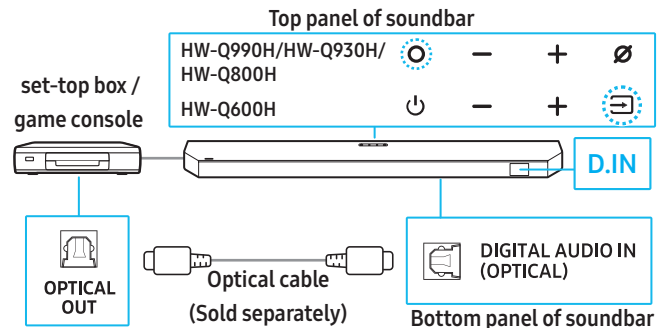

1. Use an optical cable (sold separately) to connect the **DIGITAL AUDIO IN (OPTICAL)** port on the soundbar to the OPTICAL OUT port on the external device.
2. Turn on the soundbar and external device.
3. Select **D.IN** mode by pressing the **Multi** button or **Source** button at the top of the soundbar or the **Source** button on the remote control.
4. Your soundbar will play audio from the external device.

08 Connecting a Mobile Device

Connecting by Bluetooth

Connecting your mobile device to the soundbar by Bluetooth allows you to enjoy stereo sound without the need for cables.

- The soundbar will turn on if you try to connect a previously paired Bluetooth device while the soundbar is turned off.

Connecting to Bluetooth for the first time

- Position the device you are connecting to the soundbar by Bluetooth within 3.28 ft (1 m).
1. Press the **Pair** button on the Remote Control to open **BT PAIRING** mode.

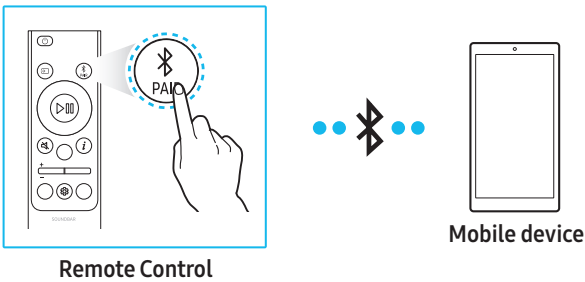

(Or)

Press the **Microphone** button or **Source** button at the top of the soundbar for 3 seconds or longer until "**BT PAIRING**" is displayed.

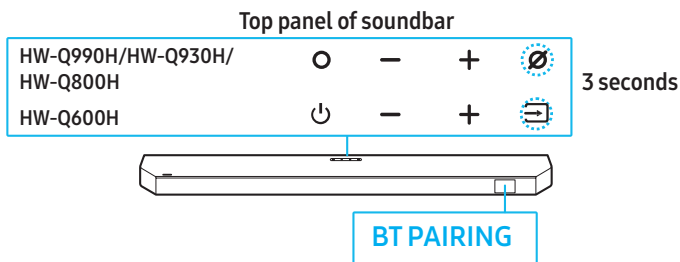

2. Select "**Q-Series Soundbar**" when it appears on the list in the device.
 - When the mobile device and soundbar are connected, [**Mobile device name**] → "**BT**" will appear on the soundbar's front panel display.
3. Enjoy music from your mobile device connected by Bluetooth through the soundbar.
 - Once you have successfully connected the soundbar to your mobile device by Bluetooth, you can use the **BT READY** mode to reconnect.

If the Device Fails to Connect

- When a previously connected soundbar (e.g., "**Q-Series Soundbar**") appears in the speaker list of your mobile device, delete it.
- Repeat steps 1 through 2.

What is the difference between BT READY and BT PAIRING?

- **BT READY**: In this mode, you can connect a previously connected TV or mobile device with the soundbar.
- **BT PAIRING**: In this mode, you can connect a new device to the soundbar.
(Press the **Pair** button on the Remote Control or press and hold the **Microphone** button or **Source** button at the top of the soundbar for 3 seconds or longer while the soundbar is in **BT** mode.)

Precautions when connecting to Bluetooth

- Position the device you are connecting to the soundbar by Bluetooth within 1 meter.
- If prompted for a PIN code when connecting to a Bluetooth device, enter <0000>.
- The soundbar will automatically turn off after 18 minutes of inactivity in Standby mode.
- The soundbar may have difficulty scanning for available Bluetooth devices or connecting properly under the following conditions:
 - If there are nearby electronic devices or equipment causing radio interference.
 - If multiple Bluetooth devices are simultaneously paired with the soundbar.
 - If the Bluetooth device is turned off, out of range, or experiencing a malfunction.
- Electronic devices may cause radio interference. Keep any device that generates electromagnetic waves away from the soundbar. (e.g., microwave oven, wireless LAN, etc.)
- The soundbar supports SBC data (44.1kHz, 48kHz).
- Only connect to Bluetooth devices that support A2DP (AV).
- When connecting the soundbar to a Bluetooth device, keep them as close to each other as possible.
- The greater the distance between the soundbar and Bluetooth device, the lower the audio quality will be. The Bluetooth connection may be lost if the devices are out of range.
- The Bluetooth connection may not work properly in areas with weak signal reception.
- A Bluetooth device may experience noise or malfunction under the following conditions:
 - If a part of your body comes in contact with the signal transceiver of the Bluetooth device or soundbar
 - In corners or when there is an obstacle in proximity, such as a wall or partition, where electrical changes may occur.
 - When exposed to radio interferences by other products operating on the same frequency ranges, such as medical equipment, microwave ovens, and wireless LAN devices.
 - Obstacles such as doors and walls may degrade audio quality even if the devices are within operational range.
- Note that your soundbar can't be paired with other Bluetooth devices while Bluetooth audio is being played.
- This wireless device may cause electrical interference during operation.

Disconnecting a connected Bluetooth device

Refer to the Bluetooth device's user manual for more details.

- When the soundbar is disconnected from the Bluetooth device, "**BT DISCONNECTED**" will appear on the front display.

Disconnecting the soundbar from the Bluetooth device

Press the **Multi** button or **Source** button at the top of the soundbar or **Source** button on the remote control and switch to any other mode besides **BT**.

- Ending the connection may take a few seconds as the Bluetooth device waits for a response from the soundbar. (The disconnection time may vary, depending on the Bluetooth device.)

- When the soundbar is disconnected from the Bluetooth device, “**BT DISCONNECTED**” will appear on the front display.

Connecting by Wi-Fi (Wireless Network)

For **Samsung Sound** to work properly, a specific or higher version of the OS is required.

For more information on OS versions, please see the **Samsung Sound** App description in the app marketplace for your OS.

1 - Installing app



You can control the soundbar and adjust settings using the **Samsung Sound** app.

Download the **Samsung Sound** app from the App store or Play store on your mobile device or scan or click the QR code to download the app.

2 - Registering a device

1. On your mobile device, run the **Samsung Sound** app.
2. Follow the instructions displayed to register the product to your mobile device.
 - If a pop-up window doesn't appear, go to the app's home screen, then tap the (**+**) button to register the product.

NOTE

- You can also register your soundbar to the **Samsung Sound** app by scanning the QR code on the soundbar.

If the device isn't found

1. Connect the mobile device to the soundbar by Bluetooth.
2. Tap Connected Devices in the **Samsung Sound** App.
3. Slide left on the screen to select the soundbar card on your mobile device. Then, tap Register device to Samsung account to register the device.

3 - Controlling the Soundbar with Samsung Sound

1. Open the **Samsung Sound** app on your device, and then select the soundbar you have registered.
2. The settings menu will appear for the soundbar, and you can adjust the settings such as **Volume**, **Sound Mode**, and **Advanced Sound Settings**.
 - If a different user wants to control the soundbar, the user can tap the “**Menu (☰) How to Use > Share control of devices**” in the **Samsung Sound** app on their mobile device.

To change your Wi-Fi (wireless network)

1. On your mobile device (smartphone or tablet), run the **Samsung Sound** app.
2. After tapping the soundbar card, tap the (**⋮**) icon.
3. Tap **Device settings > Network status > Change Wi-Fi network**, then follow the on-screen instructions.

Using Group Play

- To use this feature, register your soundbar to the **Samsung Sound** app.
- This feature is only available on soundbar models released in 2024 or later.
- To turn on this feature, connect two or more devices to the same 5GHz Wi-Fi network.
- Menu names and settings may differ depending on the version of the Samsung Sound app.

Configuring Group Play

1. On your mobile device, run the **Samsung Sound** app.
2. To register your soundbar to the **Samsung Sound** app, refer to the “**Connecting by Wi-Fi (Wireless Network)**” section.
3. Tap on the soundbar card.
4. Set the soundbar source to Wi-Fi or Bluetooth.
5. On your mobile device, tap **Group Play Settings** under the audio device icon.
6. Turn on **Group Play**.
7. Select a device from the list and tap **Apply**.
 - We recommend connecting no more than 4 devices.
 - In **Group Play**, audio from mobile devices connected to the host device will be output through the speakers connected in the group.
 - When the soundbar is connected to the TV by Wi-Fi, TV audio will be switched to the TV speakers.
 - If a device connected to the host device switches to another source, then that device is removed from the group.
 - When you connect a host device to the TV, the group that was created is deleted.

Disabling Group Play

1. Tap on the soundbar card.
2. On your mobile device, tap **Group Play Settings** under the audio device icon.
3. Turn off **Group Play**.
 - To remove several devices, deselect (unmark) them in the list and tap **Apply**.

Connecting to Apple AirPlay®

- This feature may not be available in some countries.
- The latest version of iOS, iPadOS, or macOS is recommended.
- To enable **AirPlay®** in your Soundbar, you must first register the device with the Samsung **Samsung Sound** app by agreeing with the app's terms and conditions.
- Make sure the Soundbar is powered on and connected to the same Wi-Fi network as your Apple® device.
- Apple®, AirPlay®, iPad®, iPhone®, and Mac® are trademarks of Apple Inc., registered in the U.S. and other countries and regions.

With **AirPlay®**, you can enjoy music, podcasts, and other audio on the Samsung Soundbar right from your Apple® devices.

- Select  from an AirPlay-supported app or Control Center on your iPhone®, iPad®, or Mac®.
- Select the Soundbar from the list of available devices to play the current audio to.

09 Installing the Soundbar on a Wall

Precautions when installing

- Mount the soundbar only on a vertical wall.
- Avoid installing the soundbar system in areas with high temperatures or humidity.
- Install the system on a sturdy wall capable of supporting the soundbar's weight. If the wall can't support the soundbar's weight, reinforce it before installation. If reinforcement isn't possible, choose a different wall that can support the soundbar.
- Use screws or anchors suitable for the wall where the soundbar is being installed.
(Gypsum board/steel/wood, etc.)
If possible, install the screws directly into the wall.
- Turn off the power and disconnect the soundbar before mounting it on the wall.
Failure to do so may result in electric shock.
- Connect all cables from external devices before mounting the soundbar on the wall.

Wall Mount Components

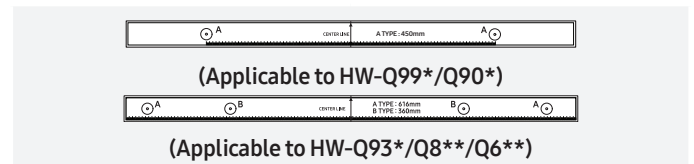

Ⓐ Wall-mounting Guide

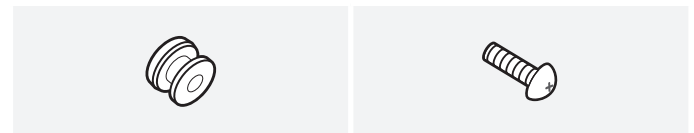

Ⓑ Holder-Screw x2

Ⓒ Screw (M4 x L10) x2



Ⓓ Wall-mounting Bracket x2

1. Attach the **Wall-mounting Guide** to the wall.
 - Attach the **Wall-mounting Guide** parallel to the wall.
 - If your TV is mounted on a wall, install the soundbar at least 5 cm (2 inches) from the bottom of the TV.

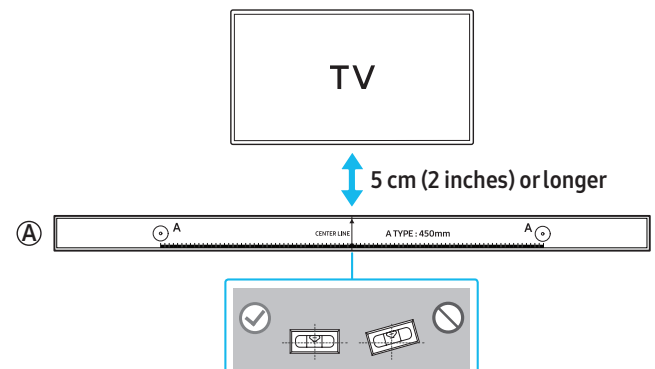

2. Align the **Wall-mounting Guide's center line** with the center of the TV on the wall (If you are mounting the soundbar below the TV), and then use tape to secure the **Wall-mounting Guide**.

- If you aren't mounting below a TV, place the **Center line** in the center of the installation area.

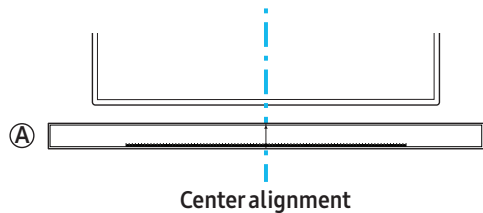

3. Use a pen or pencil to mark the center of the **A-TYPE** hole, and then remove the **Wall-mounting Guide**.

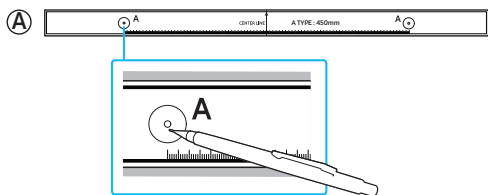

4. Using an appropriately sized drill bit, drill a hole where you marked on the wall.

5. Twist the screw through each **Holder screw**, and then fasten the **Screw for mounting on wall** into the marked spot.

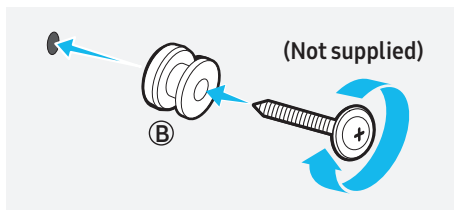

6. Install 2 **Wall-mounting Brackets** in the correct orientation at the bottom of the soundbar, using 2 **screws**.

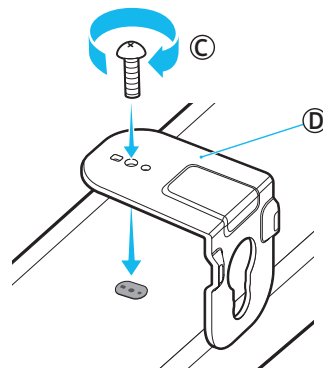

- When assembling, make sure the hanger part of the **Wall-mounting Brackets** are located behind the rear of the soundbar.

Rear side of soundbar

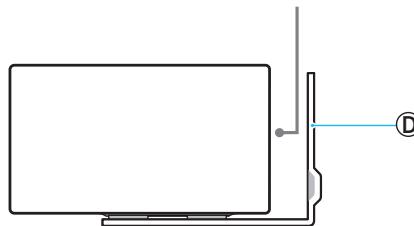

Right side of soundbar

7. With the **Wall-mounting Brackets** firmly attached, hang the soundbar on the **Holder Screws**.

- Insert the **Holder Screws** into the wide (bottom side) holes of the **Wall-mounting Brackets** so that the **Wall-mounting Brackets** are firmly secured in the **Holder Screws** and then push the **Wall-mounting Brackets** down.

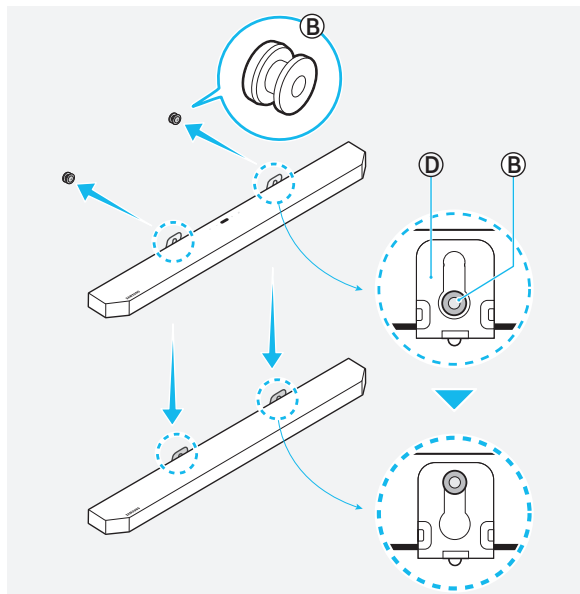

Installing the Surround Speakers on a Wall

Wall mounts need to be purchased separately to install the surround speakers on a wall.

Samsung Electronics doesn't sell wall mounts.

Notes for mounting surround speakers on a wall

- The wall used to mount the surround speakers must be able to support at least 8 kg (17.6 lbs).
- Hole size: fits 1/4 – 20 UNC screw
 - Standard screw: 6.35 mm (0.25 inches) \varnothing , 1.27 mm (0.05 inches) pitch
 - Length: 18 mm (0.7 inches)
 - Quantity: Left 1 / Right 1

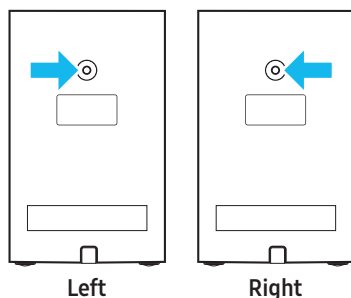

- Before installing the Wall-mounting Bracket, check whether the wall is sturdy enough. If the wall can't bear the weight of the soundbar, reinforce the wall before installing the Wall-mounting Brackets and soundbar.
- Samsung Electronics isn't responsible for any damage to the product because of improper installation.
- Take care not to install the speakers sideways or upside down.

10 Installing the Soundbar on top of the TV Stand

Parts

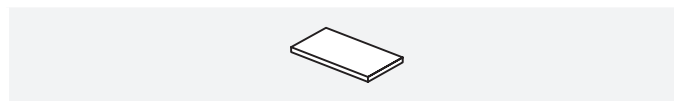

Rubber Foot x4

1. Attach the rubber foot to the bottom of the soundbar before placing it on top of the TV stand. The rubber foot should not be placed in a way that it extends beyond the TV stand's width. Please see the diagram below.

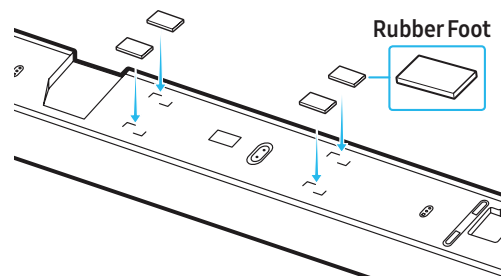

2. Install the soundbar on your TV. As shown in the image, align the center of the TV with the center of the soundbar, then carefully place the soundbar into the TV stand.

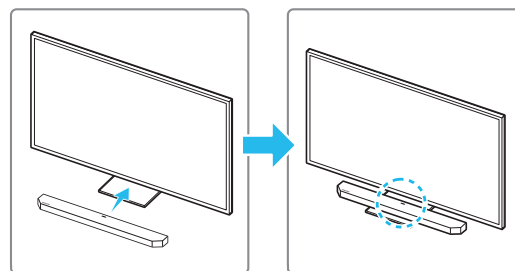

Make sure the microphone isn't blocked when placing the soundbar near the stand to ensure proper voice recognition.

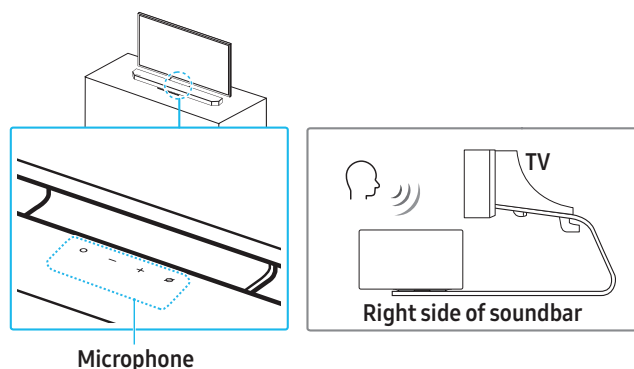

NOTE

- This feature is not supported on the HW-Q600H model.
- Make sure the soundbar is placed on a flat and solid surface.
- If the soundbar is too close to the TV, voice recognition may be affected, and audio issues could occur.
- The actual product may vary in appearance from the image above, depending on the model.
- Place the soundbar at least 2 cm (0.8 inches) away from the TV for optimal microphone performance.

11 Software Update

Automatic update

If your soundbar is connected to the internet, the software will automatically update even, while the soundbar is turned off.

- To use the automatic update feature, the soundbar must be connected to the internet.
If power to the soundbar is cut off or disconnected, the Wi-Fi connection will be lost. If power is cut off, turn the soundbar back on, or disconnect the power cord and then connect it again. Then, turn on the soundbar, and reconnect it to the internet.

USB update

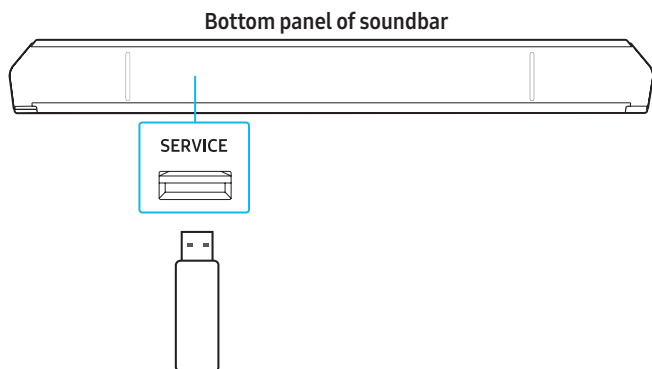

Samsung may provide firmware updates in the future for performance enhancements to the soundbar system.

If a new update is available, you can update the soundbar by connecting a USB storage device containing the firmware update to the **SERVICE** port on the soundbar.

1. Go to the Samsung website (www.samsung.com) → Go to Customer Support and search for your soundbar model name.
 - For more information on firmware updates, see the upgrade guide.
2. Download the Upgrade File (USB Type).
3. Unzip the downloaded compressed file into a folder created with an identical name to the compressed file.
4. Save the created folder to a USB thumb drive and connect it to the soundbar.
5. Turn on the soundbar. **"UPDATE"** will appear on the display within 3 minutes at which point the update will begin.
 - Do not turn off the power or disconnect the USB thumb drive while the update is in progress.
 - If **"UPDATE"** doesn't show on the soundbar display, reconnect the soundbar's power cord.
 - If your soundbar has the latest firmware installed, the update won't run.
 - The update may not run, depending on the type of USB thumb drive.

Security updates information

Security updates are provided to strengthen the security of your device and protect your personal information. For more information on security updates, visit <https://security.samsungtv.com>.

- The website supports only some languages.

Reset

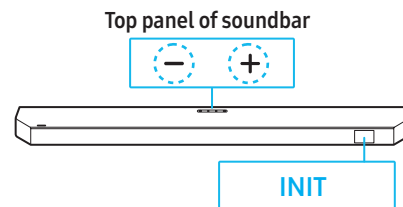

While the soundbar is turned on, press both **— + (Volume)** buttons on the soundbar for 5 seconds or longer. **"INIT"** will appear on the front display and the soundbar will reset.

⚠ CAUTION

- This will reset all settings of the soundbar. Reset the soundbar only when needed.

12 Troubleshooting

Refer to the instructions below if this product does not function properly. If the problem you are experiencing is not listed below or if the instructions below do not help, turn off the product, disconnect the power cord, and contact Samsung Electronics at 1-800-SAMSUNG (1-800-726-7864).

When the power doesn't turn on

- Check if the power cord is securely connected to the soundbar.

When some functions aren't working properly

- Disconnect the power cord, then connect it again.
- Turn off the connected external device, and then turn it back on.
- If there is no signal input, the soundbar will automatically turn off after a certain period.
Turn on the power.

If the remote control isn't working properly

- Bring the remote control closer to the soundbar and point it directly at the soundbar to select inputs.
- Replace the batteries with new ones.

When the soundbar indicator light stays red

- The microphone is turned off. When the microphone is turned on, the indicator will turn off. (See the "[Product Overview](#)" section.)

If there is no sound coming from the soundbar

- The soundbar volume may be low, or the soundbar may be set to mute. Adjust the volume levels.
- When using external devices (STB, Bluetooth device, mobile device, etc.) connected to the soundbar, adjust the volume on each device.
- The sound output may be set to the TV. Select the soundbar as the sound output for the TV. (Samsung TV Home (🏠) → Settings (⚙️) → All Settings (⚙️) → Sound → Sound Output → Select Soundbar)
- The cable connected to the soundbar may be loose. Disconnect the cable from the soundbar and then connect it again.
- Disconnect the power cord, connect it again, and then turn the soundbar on.
- Reset the soundbar and try again. (See the "[Reset](#)" section.)

If there is no sound from the subwoofer or surround speakers

- Check if the LED indicator on the rear of the subwoofer or surround speaker is blue. If the indicator is red or blinking blue, reconnect the soundbar to the subwoofer and surround speakers. (See the "[Manually Connecting the Subwoofer and Surround Speakers](#)" section.)
- If an object is placed between the soundbar and subwoofer, this can cause issues. Move the subwoofer to a place where there is no interfering object.
- If there is a device emitting radio frequency signals nearby, it may interrupt the connection.
Keep the soundbar or speakers away from such devices.
- Disconnect the power plug, then connect it again.

If the subwoofer or surround speaker emits noise or a stuttering sound

- If an object is placed between the soundbar and subwoofer, this can cause issues. Move the subwoofer to a place where there is no interfering object.
- Audio can be interrupted when the subwoofer and surround speakers are placed far away from the soundbar. Place them closer to the soundbar.
- If there are devices near the Soundbar that may cause wireless interference, the sound may be interrupted. Keep them at least 3.3 ft (1 m) away. Examples: Wireless router or smart outlet with an automatic standby power cut-off feature.
- Change the TV network connection from wireless to wired.

When the subwoofer sound is low

- The original audio that is currently being played may have a low volume. Adjust the level of the subwoofer by using the **WOOFER** button on the remote control.
- Bring the subwoofer speaker closer to you.

When the TV can't connect to the HDMI TO TV (eARC/ARC)

- Make sure the HDMI cable is securely connected to the ARC or eARC port. (See the "[Connect to a TV that supports HDMI ARC \(Audio Return Channel\)](#)" section.)
- The soundbar connection may not work due to other devices (such as set-top boxes, game consoles, etc.) connected to the TV. Connect only the soundbar to the TV, without any other devices.
- HDMI-CEC may not be turned on for the TV. Enable CEC in the TV menu. (Samsung TV: Home (🏠) → Settings (⚙️) → All Settings (⚙️) → Connection → External Device Manager → Anynet+ (HDMI-CEC) ON)
- To connect with eARC, the eARC function in the TV menu should be turned on. (Samsung TV: Home (🏠) → Settings (⚙️) → All Settings (⚙️) → Sound → Expert Settings → HDMI-eARC Mode (Auto))

There is no audio when the TV is connected in HDMI TO TV (eARC/ARC) mode

- The soundbar can't reproduce the inputted signal. Change the TV's audio output to PCM or Dolby Digital. (Samsung TV: Home (🏠) → Settings (⚙️) → All Settings (⚙️) → Sound → Expert Settings → Digital Output Audio Format)

When a Bluetooth connection can't be established

- When connecting a new device to the soundbar, switch to **BT PAIRING** to connect. (Press the **Pair** button on the remote control or press and hold the **Microphone** button or **Source** button at the top of soundbar for 3 seconds or longer.)
- If the soundbar is connected to another device, disconnect that device first to switch to another device.
- Remove the speaker from the Bluetooth speaker list in the device, then reconnect. (Samsung TV: Home (🏠) → Settings (⚙️) → All Settings (⚙️) → Sound → Sound Output → Bluetooth Speaker List)
- The TV CONNECT feature may be turned off. While the soundbar is in "**BT READY**", press and hold the **Left** button on the Soundbar remote control for 5 seconds to select **ON-TV CONNECT**. If you see **OFF-TV CONNECT**, press and hold the **Left** button for 5 seconds to switch the selection.
- Disconnect the power plug, connect it again, and then try again.
- Reset the soundbar and try again. (See the "[Reset](#)" section.)

When the audio stutters due to a weak Bluetooth connection

- Audio may stutter if the soundbar is placed near an electronic device or appliance that causes radio interference. (e.g., microwave oven, wireless router, etc.)
- The sound may cut out if the connected device is too far from the soundbar. Please move the device closer to the soundbar.
- If your body is in contact with the Bluetooth transceiver or the soundbar is placed on metal furniture, the audio may stutter. Check the installation environment and conditions.

When a Wi-Fi connection can't be established

- Check whether your wireless router is on.
- Turn off the router, turn it back on, and then try to reconnect.
- If the wireless router signal is weak, a Wi-Fi connection may not be possible. Move the wireless router closer to the soundbar or place it in an unobstructed location.
- If you have installed a new wireless router, you'll need to reconfigure the speaker's network settings. (Refer to the "[To change your Wi-Fi \(wireless network\)](#)" section.)
- The soundbar doesn't support Wi-Fi 6.

When the TV is powered on, but the soundbar doesn't turn on together with it

- When you turn off the soundbar first while watching TV, the Auto Power Link on the soundbar will also be turned off. Power off the TV first.

The AVA Pro feature can't be used in the following cases. (Only supported on certain models.)

- The AVA Pro feature can't be used when the microphone is turned off.

My TV and soundbar are connected, but when I switch to soundbar mode, no audio is played through the TV speakers.

- If you connect your mobile device to the soundbar while it is connected to a TV and audio is playing, the audio output will switch to your mobile device's, but the soundbar will remain connected to the TV. The TV audio won't make sound from any speakers in this case.
- When you end the connection between your mobile device, the soundbar will play the TV audio.

If the soundbar does not appear in the list of AirPlay-compatible devices

- Ensure that you have agreed to the terms of use for the Samsung Sound app and register the device. (See the "[Connecting to Apple AirPlay®](#)" section.)
- Ensure that the soundbar is not deleted from the Samsung Sound app.
- Check and see if your soundbar and your Apple devices are connected to the same Wi-Fi network.
- Note that iOS version 13.4 or later is required.

The TV doesn't display the UHD input signal.

- You may need to adjust the settings on your TV or source device. Refer to your TV manual or device manual for more details.
- Check if your Ultra High Speed HDMI cable is certified by HDMI.org. (HW-Q990H/Q900H models only)

Group Play isn't activated.

- Check that your audio device is a new model released in 2024 or later.
- Check to make sure that the host device, which is the source, is connected to the Wi-Fi network.
- The audio devices must be connected to the same Wi-Fi network (5GHz).

13 Licenses & Other Information



Dolby, Dolby Audio, Dolby Atmos, and the double-D symbol are registered trademarks of Dolby Laboratories Licensing Corporation. Manufactured under license from Dolby Laboratories. Confidential unpublished works.

Copyright © 2012-2026 Dolby Laboratories. All rights reserved.



Manufactured under license from DTS, Inc. and/or its affiliates. For patents, see <https://xperi.com/dts-patents/>. DTS, the DTS logo, DTS:X, and the DTS:X logo are trademarks or registered trademarks of DTS, Inc. and/or its affiliates in the U.S. and/or other countries. © DTS, Inc. and/or its affiliates. All rights reserved.

- This license may not be supported depending on the model or geographical area.
-



The terms HDMI, HDMI High-Definition Multimedia Interface, HDMI Trade dress and the HDMI Logos are trademarks or registered trademarks of HDMI Licensing Administrator, Inc.

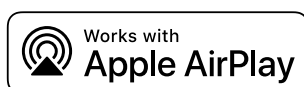

Apple®, AirPlay®, iPad®, iPhone®, and Mac® are trademarks of Apple Inc., registered in the U.S. and other countries and regions.



- Use your phone, tablet or PC as a remote control for Spotify. Go to spotify.com/connect to learn how.
 - The Spotify software is subject to third party licenses found here. <https://www.spotify.com/connect/third-party-licenses>
-



Being Roon Ready means that Samsung and Roon streaming technology, for an incredible user interface, simple setup, rock-solid daily reliability, and the highest levels of audio performance, without compromise.

Open Source License Notice

Open Source used in this product can be found on the following webpage (<http://opensource.samsung.com>).
